

Informazioni  
**IMPORTANTI**  
 Very important  
**INFORMATION**





Condizioni  
 generali di vendita  
 General sales  
 conditions

**Proiettori / Sospensioni - Floodlights**

 Pinguino serie Pag. 16	 Puma serie Pag. 16	 Tigre Pag. 24
--	---	---

 BASIC series Virgola - Virgola 3CCT Pag. 28	 Panthera Pag. 30	 NEW 2026 Amalfi Pag. 34
---	---	---

 Leo Pag. 36	 Milano Sport 1 - 2 - 3 - 4 Pag. 38	 Lampo serie Pag. 46	 Tunnel Top Pag. 53
--	---	---	---

 Minizeus - Zeus Pag. 58	 Milano Logistica Pag. 66	 BASIC series Punto - Punto 3CCT Pag. 68	 Zeus ATEX 2-22 Pag. 70
---	--	--	--

**Apparecchi stagni - Waterproof luminaires**

 AGP Evolution ATEX 2-22 Pag. 72	 LED Lampo Logistica S Pag. 74	 Allegra Plus Pag. 76	 Allegra+ - High efficiency Pag. 80
---	---	--	--

 BASIC series Allegra Basic 3CCT Pag. 84	 Pupilla sensor DIM Pag. 86	 Allegra ATEX 2-22 Pag. 88	 Allegra Metal Linea passante - Loop in - Loop out Pag. 90
---	--	---	--

**Arredo urbano / Illuminazione stradale - Urban lighting / Street lighting**

 Lanterna Pag. 92	 Lampione 2 Pag. 98	 Lampione 4 Pag. 98	 Lampione 6 Pag. 100
---	---	---	--

 Lampione 7 Pag. 100	 Lampione 8 Pag. 102	 Lampione 9 Pag. 102	 Lampione 10 Pag. 104	 Lampione 12 Pag. 104
---	---	---	--	--

**Arredo urbano / Illuminazione stradale - Urban lighting / Street lighting**

 Gardena Pag. 110	 Sempione serie Pag. 114	 Gran Sasso serie Pag. 122	 NEW 2026 Pordoi Pag. 127
--	---	---	--

**Lampade residenziali - Residential lights**

 NEW 2026 Folgore Pag. 130	 Monza Round Pag. 134	 Tuba Lux Pag. 137	 Positano Pag. 139
---	--	---	---

 Capri mini - Capri Pag. 140	 Ischia serie Pag. 142	 Ovest Pag. 148	 Cubo Pag. 149
--	--	---	--

 Nord Pag. 150	 Maga serie Pag. 152	 Asso Round 3 CCT Pag. 156	 Asso Square 3 CCT Pag. 158
---	---	---	--

Lampade residenziali - Residential lights

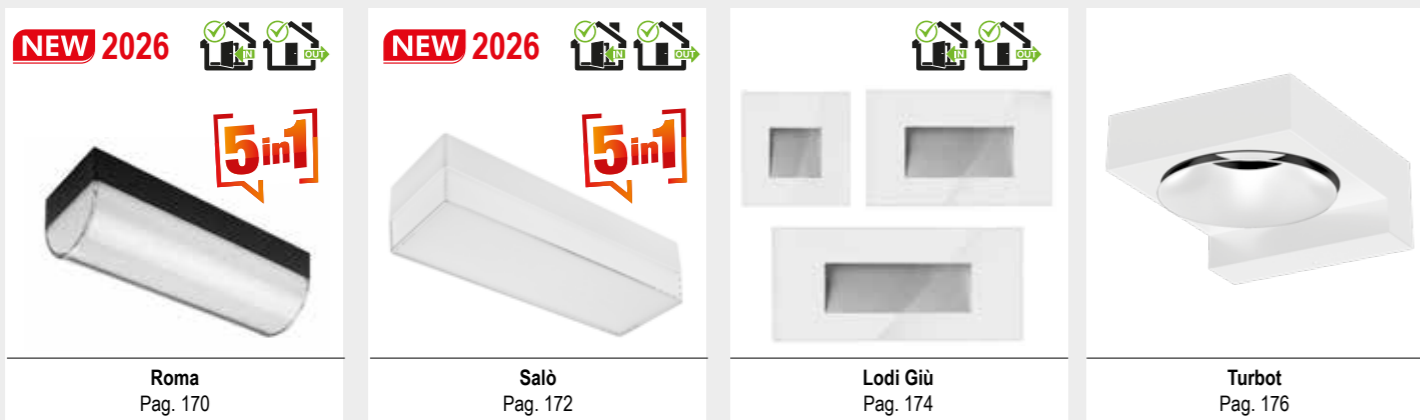

Lampade residenziali - Residential lights



Incassi residenziali - Residential recessed



RGB



Informazioni  
**IMPORTANTI**  
Very important  
**INFORMATION**

Condizioni  
generali di vendita  
General sales  
conditions

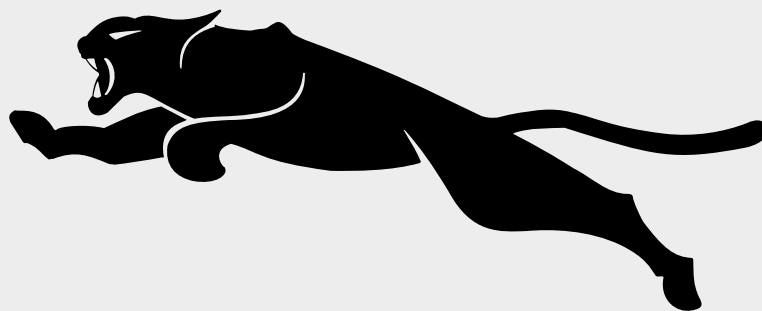

Nasce nel 1967 dalla passione e dall'ingegno di Giuseppe Pisati e oggi dai suoi nipoti Joseph, Julius e Jodie. Il solido know-how nel campo della componentistica ha permesso a **Relco** di andare oltre, sviluppando una propria linea di apparecchi di illuminazione, da utilizzare sia in outdoor che indoor. Molti dei nostri progetti sono consultabili nel sito:  
[www.relcogroup.com](http://www.relcogroup.com)

It was born in 1967 from the passion and ingenuity of Giuseppe Pisati and today from his grandchildren Joseph, Julius and Jodie. The solid know-how in the field of components has allowed Relco to go further, developing its own line of lighting fixtures, to be used both indoors and outdoors. Many of our projects can be consulted on the site:  
[www.relcogroup.com](http://www.relcogroup.com)



## SERVIZIO AL CLIENTE - SERVICE FOR THE CUSTOMERS



### Consulta il nostro sito ottimizzato per tablet e smartphone

Dovunque tu sia potrai avere informazioni dettagliate su: prodotti, punti vendita, informazioni tecniche e commerciali, e potrai effettuare il download di cataloghi, schede tecniche e listini aggiornati in tempo reale.

[www.relcogroup.com](http://www.relcogroup.com)

### Check out our website designed for tablets and smartphones

Wherever you are, you will be able to access detailed information on: products, outlets, technical and marketing information, and you will be able to download catalogues and price lists updated in real time.



### Progettazione

La certificazione fotometrica dei nostri apparecchi viene sempre effettuata da un laboratorio fotometrico esterno. Efficienza luminosa e "lm Output" sono quindi il risultato di un ente terzo in alcun modo vincolato a Relco S.r.l. I progetti illuminotecnici sviluppati da Relco mettono a disposizione dei clienti le soluzioni più efficaci per esigenze spesso molto complesse. La definizione di ogni progetto determina un'autentica partnership tra le parti. La nostra realtà è a completa disposizione di progettisti che realizzano lavori con un alto profilo tecnologico: [projects@relcogroup.com](mailto:projects@relcogroup.com)

### Project

The lumen output performance of our lighting fixtures is always tested by third party accredited laboratories. The fixture efficiency and lm output are the results attested by a third party laboratory which is not bonded to Relco S.r.l. The lighting projects developed by Relco make the most efficient solutions to very complex issues available to customers. Defining each project results in an authentic partnership between the parties. Our company is at the full service of designers working on highly technological projects: [projects@relcogroup.com](mailto:projects@relcogroup.com)

## Confort visivo - Visual confort



### Controllo dell'abbagliamento

L'illuminazione degli spazi operativi in un'ottica smart, deve essere in grado di migliorare il senso di benessere di chi lavora seguendo le necessità degli utenti finali.

I sistemi di regolazione di **RELCO** consentono di trovare il giusto equilibrio tra luce artificiale e luce naturale proveniente dall'esterno.

Ciò consente di dare sostegno al bioritmo umano e creare le migliori condizioni visive per ogni attività.

Un ambiente confortevole sotto il profilo illuminotecnico incoraggia la creatività delle persone che lo abitano.

Relco offre soluzioni illuminotecniche globali, in grado di offrire valore aggiunto all'unione tra luce e architettura.

Ampia scelta di apparecchi LED e sistemi di comando per le applicazioni più svariate dell'illuminazione professionale di: uffici e istituti didattici, negozi, hotel e wellness, salute e cura, arte e cultura, industria e tecnica.

Relco sa trovare il giusto equilibrio fra qualità della luce ed efficienza energetica sviluppando soluzioni illuminotecniche su misura.

**Veniamo incontro alle vostre esigenze specifiche e alle necessità degli utenti, senza mai perdere di vista l'obiettivo di trovare la luce migliore per l'uomo e per l'ambiente.**

### Glare control

*The lighting of the work areas from a smart perspective must be able to improve the well-being of those who work according to the needs of end users.*

*The RELCO regulation systems allow the right balance to be found between artificial light and natural light coming from outside.*

*This allows us to support human biorhythm and create the best visual conditions for any activity.*

*A comfortable environment in terms of lighting encourages the creativity of the people who live in it.*

*Relco offers global lighting solutions, able to offer added value to the combination of light and architecture.*

*A wide selection of LED fixtures and control systems for various professional lighting applications: offices and educational institutions, shops, hotels and wellness, health and care, art and culture, industry and engineering.*

*Relco knows how to find the right balance between quality of light and energy efficiency by developing customised lighting solutions.*

***We meet your specific needs and users' needs, without ever taking our eyes off the goal of finding the best light for humans and the environment.***

### UGR<... Classificazione valori UGR in funzione delle applicazioni. UGR value classification based on application.

<b>UGR≤16</b>	<b>Applicazioni molto impegnative</b> (disegni tecnici, lavoro a videoterminale). <i>Highly demanding applications</i> (technical drawings, working with video display terminals).
<b>UGR≤19</b>	<b>Uffici e scuole</b> (lettura, scrittura, riunioni). <i>Offices and schools</i> (reading, writing, meetings).
<b>UGR≤22</b>	Applicazioni industriali, artigianato. <i>Industrial, artisanal applications.</i>
<b>UGR&gt;28</b>	Abbagliamento elevato. <i>High glare.</i>

#### Fattore di abbagliamento UGR<19

Valore contemplato secondo la norma  
(coefficiente di riflessione: soffitto 0,7 - pareti 0,5).

#### Factor glare UGR<19

Value calculated according to the standard  
(reflection coefficient: ceiling 0.7 - walls 0.5)

L'UGR è l'indicatore dell'abbagliamento diretto derivante dall'impianto di illuminazione.

La norma Europea per l'illuminazione dei posti di lavoro in interni **UNI-EN12464-1** richiede un valore UGR specifico per ogni applicazione, compreso tra 10 e 30. Più è basso il valore, minore è l'abbagliamento.

Il valore esatto di tale indice è da calcolare su progetto in quanto dipende dalla disposizione degli apparecchi illuminanti, dalle caratteristiche dell'ambiente (dimensioni, riflessioni) e dal punto di osservazione.

*UGR is the indicator to assess the direct glare coming from a lighting system.*

*The **UNI-EN12464-1** European standard for lighting indoor workplaces requires a specific UGR value for every application, ranging between 10 and 30. The lower the value, the lower the glare.*

*The exact value of this rating must be calculated in the design, as it depends on how the lighting fixtures are arranged, the features of the space (dimensions, reflections), and the viewpoint.*

# Prestazioni di alto livello - High level performances

## Aspettativa di vita del LED e suo decadimento LED service life expectancy and deterioration

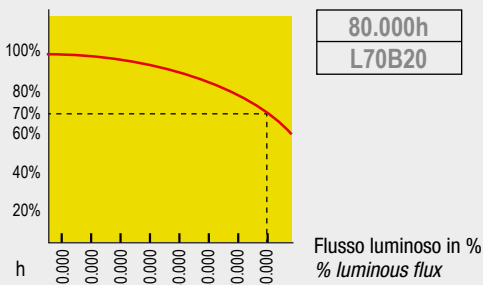

I LED diminuiscono gradualmente il loro flusso luminoso iniziale fino ad esaurirsi completamente in un periodo molto lungo. La durata di vita utile, indica la percentuale di decadimento del flusso luminoso (parametro "L") riferita ad un numero di ore utili di funzionamento. Il parametro "B" seguito da un valore normalmente compreso tra 10 e 50, indica la percentuale di componenti che, raggiunte le ore utili di funzionamento, non mantengono le caratteristiche di flusso luminoso dichiarate; ad esempio 80000h L70B20 vuol dire che l'80% dei moduli LED fornisce il 70% del flusso luminoso iniziale dopo 80000h di funzionamento.

The drop in LED flux is represented by acronym L70, which means flux at 70%. Value (B) followed by a value between 10 and 50 indicates the quality of the component being used, defining the percentage of LED that maintain the declared characteristics when the 80,000 hours have elapsed. Declared LED (L70B20) indicates that when 80,000 hours have elapsed, 80% (B20) of the LEDs have 70% of the flux they had at the beginning of their service life.

## Pittogramma Low Flicker Low Flicker pictogram



*Apparecchio con flicker molto basso  
Product with a very low flicker*

Flicker indica lo sfarfallio visibile a occhio nudo. Può verificarsi a frequenze inferiori a 60hz e dipende da diversi fattori tra cui il ripple di uscita degli alimentatori. E' importante definire "low" non vuol dire esente, ma ridotto.

Flicker is a common issue with LED lamps. It can occur at frequencies below 60 Hz and depends on several factors, such as the ripple emitted by drivers. Furthermore, "flicker-free" does not mean "without" but rather "very low".

## RIPPLE FREE

Il **RIPPLE FREE** è un esempio dello sviluppo e ricerca sui prodotti Relco Lighting & Components. I driver LED Relco Lighting & Components sono forniti di un circuito multistadio per alimentare i LED con una corrente perfetta. Con il termine RIPPLE si fa riferimento alla dimensione della forma d'onda della corrente d'uscita del driver LED. Dove il ripple è presente la forma d'onda si deforma con conseguente surriscaldamento del LED che ne riduce la vita media. Inoltre il ripple, causa oscillazioni della luce provocando disturbi durante le riprese video. Sullo schermo verranno visualizzate una serie di righe scure in movimento verso il basso che renderanno l'immagine illeggibile. Quando si alimentano i LED con LED Driver RIPPLE FREE è possibile raggiungere le massime prestazioni ed efficienza luminosa, con la minima dissipazione di calore.

The **RIPPLE FREE** is an example of R&D on the Relco Lighting & Components products. The Relco Lighting & Components LED drivers are provided with multistage circuit to feed the LEDs with a perfect current. The term RIPPLE refers to the dimension of the wave form of the LED driver output current, when present this deforms the same wave form with consequent overheating of the LED with reduced average life. Also this phenomenon, cause of light oscillations, results in effects while shooting videos, where the images appear to be cut with several black lines making shooting impossible. When you feed the LEDs with LED driver RIPPLE FREE you can achieve maximum performance and light efficiency, with minimal heat dissipation.

## Norme Europee di certificazione elettrica European norms electrical certification



Tutti i prodotti sono costruiti nel rispetto delle Normative Europee (2014/35/UE, 2006/95/CE, 2014/30/UE, 2004/108/CE, 2009/125/CE) come riportato nella dichiarazione di conformità UE.

All products are manufactured in compliance with European Directives (2014/35/UE, 2006/95/CE, 2014/30/UE, 2004/108/CE, 2009/125/CE) as reported in the UE conformity declaration.

## Sicurezza fotobiologica Photobiological safety



La sicurezza fotobiologica è determinata dalla quantità di radiazioni emesse dalle sorgenti luminose con lunghezza d'onda compresa tra 200nm e 3000nm.

Un'esposizione eccessiva alle radiazioni, può essere causa di danni per l'uomo. La norma EN62471 definisce una classificazione delle sorgenti in gruppi di rischio. RG0 Ethr: apparecchi che non presentano rischio fotobio-logico ai fini della Norma EN62471. Richiedere in sede la distanza dal punto di osservazione, se necessaria.

RG0: assenza di rischi fotobiologici ai fini della norma EN62471.

RG1 (gruppo di rischio basso): la sorgente non provoca rischi dovuti a normali limitazioni di funzionamento sull'e-sposizione.

RG2 (gruppo di rischio moderato): la sorgente non pro-voca un rischio in seguito ad una reazione istintiva guar-dando fonti molto luminose o in seguito ad una sensazio-ne di disagio termico.

*We often read about photo-biological safety in lighting design. This very important factor is determined by the amount of radiations emitted by all the sources with a wave length ranging between 200 nm and 3000 nm. Excessi-ve radiation exposure can be harmful for human health. The EN62471 standard classifies light sources into risk groups. Risk Group 0 (RG0 Ethr): luminaires are exempt from photobiological risks in compliance with standard EN 62471. If necessary, contact our customer service for the observation distance.*

*RG0 (exempt risk group): the lighting source is exempt from risks in compliance with EN 62471 Standard.*

*RG1 (low risk group): no risk deriving from a limited emission of radiation.*

*RG2 (moderate risk): the lighting source does not pose hazards because of our aver-sion response to very bright light sources, or due to the fact that we would experien-ce thermal discomfort.*



ENEC è un Marchio Europeo di Certificazione di prestazione, è stato istituito in sede CENELEC (Comitato europeo di normazione elettrotecnica) dagli organismi di certificazione elettrica che hanno aderito ad un accordo denominato "LUM AGREEMENT" per il mutuo riconoscimento di un unico marchio "ENEC" equivalente ai singoli marchi degli organismi aderenti. ENEC è un marchio ad alto valore tecnico basato su severi criteri di certificazione che offre garanzie oltre che sulla sicurezza elettrica anche sulle prestazioni dell'apparecchio elettrico. A fianco del marchio ENEC viene posto un numero che identifica l'organismo che ha rilasciato la certificazione.

*ENEC is a European Certification mark for performance established at CENELEC (Euro-pean Committee for Electrotechnical Standardization) by electrical certification institu-tions. These bodies have entered an agreement called "LUM AGREEMENT" for the mu-tual recognition of a sole mark, "ENEC", equivalent to the single marks of the adhering institutions. ENEC is a high value technical mark based on strict certification criteria which offers a guarantee not only on electrical safety but also on the performance of the electrical apparatus.*

## Certificazioni ISO 9001 ISO 9001 certification





# Protezione IP - IP Protection

Schema relativo alle cifre che compongono il grado IP	
<b>Significato relativo alla prima cifra del grado di protezione</b>	
1	Protezione da oggetti solidi maggiori di 50mm
2	Protezione da oggetti solidi maggiori di 12mm
3	Protezione da oggetti solidi maggiori di 2,5mm
4	Protezione da oggetti solidi maggiori di 1mm
5	Protezione da polveri
6	Protezione forte da polveri
<b>Significato relativo alla seconda cifra del grado di protezione</b>	
1	Protezione da gocce d'acqua
2	Protezione da gocce d'acqua deviate fino a 15°
3	Protezione da vapori d'acqua
4	Protezione da spruzzi d'acqua
5	Protezione da getti d'acqua
6	Protezione da getti d'acqua forti o mareggiate
7	Protezione contro l'immersione
8	Protezione contro l'immersione continua
9	Resistente ai getti d'acqua ad alta pressione e temperatura fino a 80°C Resistente ad alta pressione e getto d'acqua fredda fino a 15°C

Questo semplice schema ci suggerisce quindi che qualsiasi prodotto di illuminazione dovrà essere scelto in base al suo grado di protezione IP. Tale grado sarà il risultato della valutazione delle caratteristiche del luogo di installazione del medesimo prodotto e del suo impiego.

Esempi di IP presenti su alcuni apparecchi per interni ed esterni	
<b>IP44</b>	Il grado IP 44 garantisce la protezione contro la penetrazione di corpi solidi maggiori di 1 mm. Permette la protezione contro la penetrazione di liquidi da gocce, vapori o spruzzi in qualsiasi direzione
<b>IP54</b>	Il grado IP54 garantisce la protezione totale alla penetrazione di corpi solidi, di liquidi da gocce, vapori o spruzzi in qualsiasi direzione. Questo grado di isolamento non permette la penetrazione di polveri e liquidi non deve danneggiare l'apparecchiatura
<b>IP55</b>	Il grado IP55 garantisce la protezione totale alla penetrazione di corpi solidi, la penetrazione di liquidi da gocce, vapori, spruzzi e getti d'acqua in qualsiasi direzione. Inoltre non deve permettere la penetrazione di polveri e liquidi non deve danneggiare l'apparecchiatura.
<b>IP65</b>	Il grado IP65 garantisce la protezione totale alla penetrazione di corpi solidi, la penetrazione di liquidi da gocce, vapori, spruzzi e getti d'acqua in qualsiasi direzione. In questo grado di protezione, la penetrazione liquidi non deve danneggiare l'apparecchiatura
<b>IP66</b>	Il grado IP66 è garanzia di protezione totale alla penetrazione di corpi solidi e polveri, di penetrazione di liquidi da spruzzi, mareggiate e forti getti d'acqua in qualsiasi direzione. Anche in questo caso la penetrazione liquidi non deve danneggiare l'apparecchiatura
<b>IP67</b>	Il grado IP67 garantisce la protezione totale alla penetrazione di corpi solidi e polveri, la protezione contro l'immersione in acqua momentanea per 30 minuti a 1 metro di profondità.
<b>IP68</b>	Il grado IP68 permette una protezione totale alla penetrazione di corpi solidi e polveri, contro l'immersione in acqua permanente a 1 metro di profondità.
<b>IP68-xx</b>	Il grado IP68-XX permette una protezione totale alla penetrazione di corpi solidi e polveri, contro l'immersione in acqua permanente a xx metri di profondità
<b>IP69</b>	Il grado IP69 indica il massimo grado di protezione per dispositivi elettronici, garantendo, resistenza totale alla polvere, resistenza totale a getti d'acqua ad alta pressione e temperatura, fino a 80-100 bar a 80°C. resistenza ad alta pressione e getto d'acqua fredda fino a 15°C.

Diagram of the numbers that make up the IP rating	
<b>Meaning of the first numbers of the protection rating</b>	
1	Protection from solid objects larger than 50 mm
2	Protection from solid objects larger than 12 mm
3	Protection from solid objects larger than 2.5 mm
4	Protection from solid objects larger than 1 mm
5	Protection from dust
6	Strong protection from dust
<b>Meaning of the second numbers of the protection rating</b>	
1	Protection from dripping water
2	Protection from dripping water when tilted up to 15°
3	Protection from spraying water
4	Protection from splashing water
5	Protection from water jets
6	Protection from powerful water jets or sea storms
7	Protection from immersion
8	Protection from continuous immersion
9	High pressure and temperature water jet proof to 80°C Resistant to high pressure and cold water jets up to 15°C

This simple diagram suggests that any lighting fixture must be chosen based on its IP rating. This rating will be the result of an assessment of the characteristics of the place of installation of the product itself and of its use.

Examples of IPs present on some indoor or outdoor lamp	
<b>IP44</b>	The IP 44 rating ensures protection from penetrating solid bodies greater than 1 mm. It also ensures protection from dripping, spraying and splashing water in any direction
<b>IP54</b>	The IP 54 rating ensures complete protection from penetrating solid bodies as well as dripping, spraying and splashing water in any direction. This insulation rating ensures protection from dust ingress and penetrating liquids which must not damage the equipment.
<b>IP55</b>	The IP 55 rating ensures complete protection from penetrating solid bodies as well as from dripping, spraying, splashing water and water jets in any direction. Moreover, it must protect from dust ingress and penetrating liquids which must not damage the equipment
<b>IP65</b>	The IP 65 rating ensures complete protection from penetrating solid bodies as well as from dripping, spraying, splashing water and water jets in any direction. With this insulation rating, penetrating liquids must not damage the equipment.
<b>IP66</b>	The IP 66 rating ensures complete protection from penetrating solid bodies and dust ingress, as well as from dripping, spraying, splashing water, sea storms and strong water jets in any direction. In this case as well, penetrating liquids must not damage the equipment
<b>IP67</b>	The IP67 rating ensures complete protection from penetrating solid bodies and dust ingress, and from temporary immersion in water for 30 minutes at a depth of 1 metre
<b>IP68</b>	The IP68 rating ensures complete protection from penetrating solid bodies and dust ingress, from permanent immersion in water at a depth of 1 metre
<b>IP68-xx</b>	The IP68-xx rating ensures complete protection from penetrating solid bodies and dust ingress, from permanent immersion in water at a depth of xx metres
<b>IP69</b>	The IP69 rating indicates the highest level of protection for electronic devices, guaranteeing total resistance to dust, total resistance to high-pressure and high-temperature water jets, up to 80-100 bar at 80°C. Resistance to high pressure and cold water jets up to 15°C.

## Sistemi di controllo Control systems

1-10Vdc

Controllo dell'illuminazione in modo facile, elegante ed energeticamente efficiente con un dimming continuo. Permette una riduzione dei costi dell'illuminazione e del consumo di energia. Per tutti i componenti necessari vi consigliamo di fare riferimento al catalogo Relco Components scaricabile dal sito.

*Easy access mode for controlling the illumination, elegant and energy-efficient through a continuous dimming. It permits a sensible cost-reduction of the illumination energy-consume. For all required components, please refer to the Relco Components catalogue which can be downloaded from the website.*



### Digital Address Lighting Interface

La regolazione mediante l'interfaccia digitale DALI (Digital Addressable Lighting Interface) rappresenta l'evoluzione della regolazione analogica. Questa interfaccia è stata sviluppata comunemente dai più importanti produttori di alimentatori elettronici per realizzare uno standard di regolazione comune all'industria mondiale illuminotecnica.

#### Caratteristiche principali della REGOLAZIONE DALI

- Memorizzazione di scenari luminosi;
- Messaggi per lampada guasta o a fine vita;
- Nessun problema con le fasi della rete;
- Nessuna necessità di rispettare la polarità dei cavi di regolazione;
- Possibilità di assegnare un indirizzo univoco ad ogni dispositivo connesso.

*Regulation by means of DALI (Digital Addressable Lighting Interface) digital interface represents an evolution in analogical regulation. This interface has been jointly developed by the most important producers of electronic drivers to create a standard regulation for the lighting engineering industry all over the world.*

#### Main features of the DALI REGULATION

- Memory function of light scenes;
- Messages for breakdown or end of life of the lamp;
- No problem with the phases of the supply mains;
- No need to observe the polarity of the regulation cables;
- Possibility to assign a unique address to each connected device.



Sistema di controllo con l'utilizzo di pulsanti standard per la gestione della tensione di rete al fine di regolare il flusso luminoso. Con una breve pressione si potranno accendere, spegnere e regolare i driver collegati. Il funzionamento può essere effettuato da più punti. Soluzione integrabile con sensore di luce.

*Control system with the use of standard buttons for managing the mains voltage in order to adjust the luminous flux. With a short press the connected drivers can be switched on, off and adjusted. Operation can be carried out from several points. Solution that can be integrated with light sensor.*

Wireless



Sistema di controllo puntuale dell'impianto mediante tecnologia senza la necessità dell'installazione di cavi elettrici.

La gestione è possibile mediante telecomando e/o smartphone.

*Thorough installation control system via technology not requiring electrical cables to be laid.*

*Management is possible via remote control and/or smartphone.*



DMX

Protocollo per illuminazione dinamica.

Il tempo di reazione è immediato e il numero di apparecchi che si può controllare è praticamente illimitato. DMX può essere utilizzato anche per la dimmerazione delle luci di impianti sportivi.

DMX consente un'intera gamma di effetti scenici; il monitoraggio di ogni apparecchio di illuminazione e una configurazione facile da eseguire attraverso le funzioni DMX autoindirizzanti.

*Dynamic lighting protocol.*

*The reaction time is immediate and the number of devices that can be controlled is practically unlimited. DMX can also be used for dimming the lights of sports facilities.*

*DMX allows a whole range of scenic effects; the monitoring of each luminaire and an easy configuration through the self-addressing DMX functions.*



#### Sensori di luminosità/presenza

Consentono un utilizzo intelligente della luce di spazi altrimenti difficilmente gestibili, ottenendo così importanti risparmi di energia.













L'uso dei sensori è consigliato in ambienti in cui vi sia un'occupazione saltuaria o dove è necessario un livello di illuminamento costante.







#### Brightness/presence sensor

*They do permit a very flexible utilization of the light in difficult spaces, handled by a stable concept of illumination.*

*In addition, they do permit the easy handling and control of the in line with the different needs, obtaining important energy saving.*

# Legenda simboli - Symbols legend





























<b>colour</b>	Colore apparecchio - Surface finish
<b>W</b>	Watt
<b>pcs</b>	Quantità minima ordinabile - Minimum quantity to be ordered
<b>Kg</b>	Peso netto in Kg del prodotto - Net product weight in Kg
<b>A</b>	Ampere
<b>Hz</b>	Frequenza - Frequency
<b>V</b>	Volt
<b>colour</b>	Colore apparecchio - Lamp colour
<b>time/flux</b>	Autonomia/flusso - Duration/flux
<b>LED</b>	Tipo di LED - LED type
<b>S</b>	Corpo apparecchio - Body
<b>S + L</b>	Corpo apparecchio + lampada - Body + bulb
<b>CELL</b>	Corpo apparecchio + alimentazione elettronica + scheda LED Body + driver + circuit LED
<b>CELL-E</b>	Corpo apparecchio + alimentazione elettronica + lampada + emergenza Body + driver + Bulb + emergency kit
<b>Art. S</b>	Installazione a sospensione Suspended installation
<b>Art. R</b>	Installazione ad incasso Recessed installation
<b>Art. C</b>	Installazione a plafone Ceiling installation
	Rotazione dell'apparecchio sull'asse verticale e orizzontale Rotation of the device on the vertical and horizontal axis
	Dotato di vetro di protezione temperato Equipped with tempered protection glass
	Apparecchio costruito con materiali riciclabili This device is made of recyclable materials
	Apparecchio che resiste alla prova del filo incandescente The device passes the glow wire test
	Con isolamento funzionale in ogni parte e terminale o morsetto di terra se fisso With functional isolation in each part and terminal or ground clamp if fixed
	Con doppio isolamento, senza dispositivi per la messa a terra With double insulation, without ground devices
	Apparecchio in bassa tensione di sicurezza. Safety low voltage device.
	Temperatura ambiente di funzionamento - Operating ambient temperature
	Indice di Resa Cromatica Color Rendering Index
	Apparecchi calpestabili e/o carrabili con bassa emissione di calore sul diffusore. Walkover or/and drive over fitting with low heat emission on the diffuser
	HIGH EFFICIENCY
	Prodotto dotato di kit d'emergenza Article with emergency kit
<b>Lm/W</b>	Efficienza lm/W apparecchio - Efficiency lm/W unit

<b>nominal lm tc = 25°C</b>	Efficienza della sorgente luminosa - Efficiency of the light source
<b>lm output *</b>	Efficienza luminosa effettiva dell'apparecchio Effective luminous efficiency of the fixture
	Prodotto con certificazione CB Product with CB certificate
	Prodotto conforme alle direttive D.M. 11 Ottobre 2017 In compliance with the directives D.M. 11 Ottobre 2017
	Dimensioni foro incasso Hole for fitting dimensions
	Resistenza dell'apparecchio alla penetrazione di liquidi o solidi Devices resistance to the penetration of liquids or solids
	Grado di resistenza agli urti Impact resistance degree
	LED COB full color
	LED SMD singol color
	Resistenza dell'apparecchio alla penetrazione di liquidi o solidi Devices resistance to the penetration of liquids or solids
	LED COB FULL COLOR
<b>K</b>	Temperatura di colore in Kelvin Kelvin colour temperature
<b>3000K</b>	Temperatura di colore in Kelvin - luce calda Kelvin color temperature - warm white
<b>4000K</b>	Temperatura di colore in Kelvin - luce neutra Kelvin color temperature - day lights
<b>6000K</b>	Temperatura di colore in Kelvin - luce fredda Kelvin color temperature - cool lights
	A richiesta 4000K On request 4000K
	A richiesta 6000K - On request 6000K
<b>1-10Vdc</b>	Controllo dell'illuminazione in modo facile, con un dimming continuo. Easy access mode for controlling the illumination, a continuous dimming.
	Sistema di controllo della luminosità attraverso pulsanti NA  Brightness control system through NO buttons 
	Driver incluso nel prodotto Driver included in the product
	Driver non incluso, da ordinare a parte Not included driver, to be ordered separately
	<b>Tutti gli apparecchi di illuminazione di questo catalogo utilizzano un Driver LED "MULTIPOWER". A richiesta, per quantità, è possibile cambiare in fabbrica la taratura della corrente e, di conseguenza potenza (W) e Lumen (Lm)</b> <b>All the luminaires in this catalog use a "MULTIPOWER" LED Driver. On request, for quantity, it is possible to change the current calibration in the factory and, consequently, power (W) and Lumen (Lm)</b>
Il flusso luminoso uscente dall'apparecchio viene indicato con una tolleranza di ± 10%. The luminous flux exiting the fixture is indicated with a tolerance of ± 10%.	

\* Lm Output

La certificazione fotometrica dei nostri apparecchi viene sempre effettuata da un laboratorio fotometrico esterno. Efficienza luminosa e Lumen Output sono quindi il risultato di un ente terzo, in alcun modo vincolato a Relco S.r.l. Il Flusso luminoso output riportato indica il flusso uscente dell'apparecchio di illuminazione con una tolleranza ± 10% rispetto al valore indicato. The photometric certification of our appliances is always carried out by an external photometric laboratory. Luminous efficiency and Lumen Output are therefore the result of a third party, in no way bound to Relco S.r.l. The reported output luminous flux indicates the output flux of the lighting fixture with a tolerance of ± 10% compared to the indicated value.

# Legenda simboli - Symbols legend

Applicazione apparecchi - <i>Appliance application</i>		Colore corpo apparecchi - <i>Luminaire body color</i>	
	Adatto per installazione in luoghi di culto. <i>Suitable for installation in places of worship.</i>		Bianco - <i>White</i>
	Adatto per installazione in Hotel, Alberghi e luoghi di soggiorno. <i>Suitable for installation in hotels and places to stay.</i>		Nero - <i>Black</i>
	Adatto per installazione in aule scolastiche. <i>Suitable for installation in classrooms.</i>		Grigio - <i>Grey</i>
	Adatto per installazione in uffici con stazionamento di addetti a videoterminale. <i>Suitable for installation in offices with employees working at video terminals.</i>		Argento sabbia - <i>Sanded silver</i>
	Adatto per installazione in uffici, corridoi, sale riunioni. <i>Suitable for installation in offices, corridors, meeting rooms.</i>		Argento - <i>Silver</i>
	Adatto per installazione in palestre, centri sportivi. <i>Suitable for installation in gyms, sports centres.</i>		Alluminio lucido - <i>Polished aluminum</i>
	Adatto per illuminazione di opere d'arte, quadri. <i>Suitable for lighting works of art, paintings.</i>		Trasparente - <i>Transparent</i>
	Adatto per installazione in Ospedale. <i>Suitable for installation in hospitals.</i>		Cromo - <i>Chrome</i>
	Adatto per installazione in Ipermercati, Supermercati. <i>Suitable for installation in hypermarkets, supermarkets.</i>		Oro - <i>Gold</i>
	Adatto per installazione in negozi in genere. <i>Suitable for installation in shops in general.</i>		Argento lucido - <i>Polished Silver</i>
	Adatto per installazione in parcheggi. <i>Suitable for installation in car parks.</i>		Trasparente - <i>Transparent</i>
	Adatto per installazione all'aperto, terrazzi anche scoperti. <i>Suitable for installation outdoors, even open terraces.</i>		Specchio - <i>Mirror</i>
	Adatto per installazione in bagni. <i>Suitable for installation in bathrooms.</i>		Vetro satinato - <i>Frosted glass</i>
	Adatto per installazione in zone umide. <i>Suitable for installation in wet areas.</i>		Vetro fumè - <i>Fumè glass</i>
			Rame - <i>Copper</i>

## Apparecchi in emergenza - *Emergency wired luminaires*

### Apparecchi di illuminazione cablati in emergenza

Relco nella politica di offrire un servizio migliore alla clientela, ha deciso di utilizzare nei suoi apparecchi di illuminazione dotati di emergenza, solo INVERTER PER EMERGENZA CON AUTOTEST.

Le norme europee EN 1838, EN 60598-2-22, relative ai sistemi di illuminazione di emergenza, impongono che periodicamente, siano effettuati dei test per verificare sia il funzionamento sia l'efficienza (durata in emergenza) degli apparecchi di illuminazione che svolgono anche la funzione di illuminazione di emergenza. Questo costringe i manutentori dell'impianto ad interrompere la linea di alimentazione ed effettuare test con cadenza settimanale (test funzionale), e con cadenza trimestrale o annuale (test di autonomia).

Con i nostri kit di emergenza con autotest (conformi alla normativa europea EN 62034) queste prove vengono svolte automaticamente con cadenza programmabile in fase di installazione. Inoltre il nostro inverter analizza i tempi di normale accensione e spegnimento dell'apparecchio ed effettua (qualora possibile) i test nelle ore di assenza delle persone.

Eventuali anomalie sono segnalate tramite un indicatore (led) rosso verde.

A partire dal colore della segnalazione è possibile stabilire in maniera univoca gli eventuali problemi di funzionamento come evidenziato nella tabella seguente.

### Emergency wired luminaires

Relco in its policy of offering a better service to customers, has decided to use only EMERGENCY INVERTER WITH SELF-TEST in its luminaires equipped with emergency.





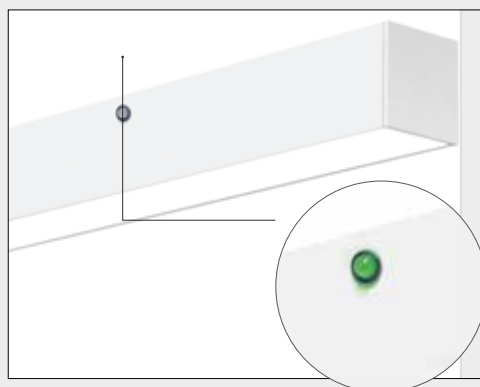

The European standards EN 1838, EN 60598-2-22, relating to emergency lighting systems, require that tests be periodically carried out to verify both the functioning and the efficiency (duration in emergency) of the lighting fixtures which also the emergency lighting function. This forces the system maintainers to interrupt the power supply line and carry out tests on a weekly basis (functional test), and on a quarterly or annual basis (autonomy test).

With our emergency kits with self-test (complying with European standard EN 62034) these tests are carried out automatically with a programmable cadence during installation.

Furthermore, our inverter analyzes the normal switching on and off times of the appliance and carries out (where possible) the tests in the hours when people are absent.

Any anomalies are signaled by a red-green indicator (led). Starting from the color of the signal, it is possible to unequivocally establish any functioning problems as shown in the following table.



Colore LED - <i>LED indication</i>		Stato - <i>Status</i>
	Verde fisso - <i>Permanent Green</i>	Batteria carica o in carica - <i>Battery charge or charging</i>
	Verde lampeggiante - <i>Flashing Green</i>	Funzione TEST avviata - <i>TEST in progress</i>
	Verde lampeggiante lento (1s ON - 1s OFF) Slow flashing green (1s ON - 1s OFF)	TEST di autonomia avviato Autonomy TEST in progress
	Rosso fisso - <i>Permanent Red</i>	Lampada guasta - <i>Lamp failure</i>
	Rosso lampeggio veloce (0,1s ON - 0,1s OFF) Fast flashing Red (0,1s ON - 0,1s OFF)	Guasto circuito di ricarica - <i>Charging failure</i>
	Lampeggio Rosso lento (1s ON - 1s OFF) Slow flashing Red (1s ON - 1s OFF)	Batteria guasta - <i>Battery failure</i>
	Verde e Rosso OFF - <i>Green and Red OFF</i>	Emergenza ON - <i>Emergency ON</i>



# LED Micro Pinguino - LED Pinguino - LED Puma - LED Maxi Puma



LED Maxi Puma - LED Maxi Puma ASY

LED Puma - LED Puma ASY

LED Pinguino - LED Pinguino ASY

LED Micro Pinguino



Floodlight

A richiesta - On demand



Vedi Pag. VI - See page VI



# LED Pinguino Eye - Luce solo all'occorrenza - Light only when needed

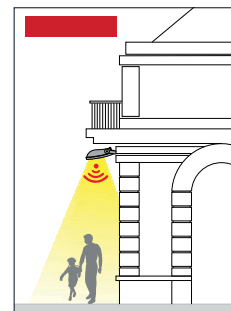
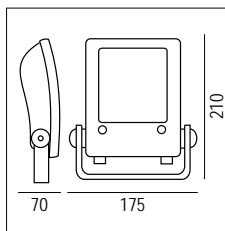
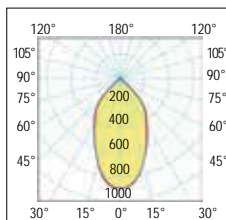

**60°**  
Semi-diffondente - Flood

colour	W	angle	K	nominal lm tc = 25°C	lm output	lm/W	pcs	Kg	CELL
<b>G</b>	15	60°	4000	2200	1800	120	4	0,50	28203/LED/EYE
<b>G</b>	30	60°	3000	4400	3600	120	4	0,50	28205/LED/EYE
<b>G</b>	30	60°	4000	4400	3600	120	4	0,50	28206/LED/EYE

A richiesta: per quantità minima 100 pezzi disponibili a 2700K  
On demand: for quantity min 100 pcs available 2700K

# LED Pinguino ASY

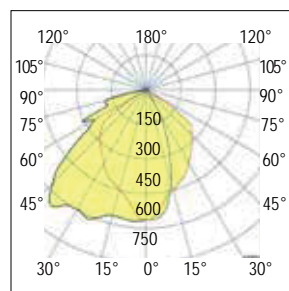
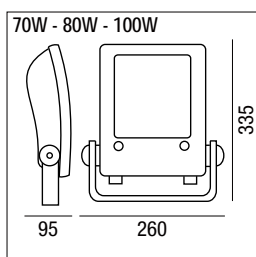
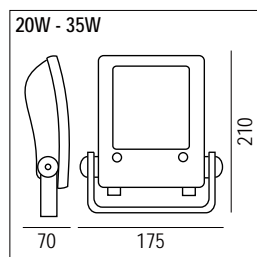

**ASY**  
Asimmetrico - Asymmetric

	colour	W	angle	K	nominal lm tc = 25°C	lm output	lm/W	pcs	Kg	CELL
	<b>G</b>	20	ASY	3000	3400	3000	150	4	3,20	20ASY-3K
	<b>G</b>	20	ASY	4000	3400	3000	150	4	3,20	20ASY-4K
<b>DYNA</b>	<b>G</b>	20	ASY	3000	3400	3000	150	4	3,20	35ASYDYNA5-3K
<b>DYNA</b>	<b>G</b>	20	ASY	4000	3400	3000	150	4	3,20	35ASYDYNA5-4K
	<b>G</b>	35	ASY	3000	5.000	4.400	125	4	3,20	28203/L/AS-3K
	<b>G</b>	35	ASY	4000	5.000	4.400	125	4	3,20	28203/LED/AS
<b>DYNA</b>	<b>G</b>	35	ASY	3000	5.000	4.400	125	4	3,20	50ASYDYNA5-3K
<b>DYNA</b>	<b>G</b>	35	ASY	4000	5.000	4.400	125	4	3,20	50ASYDYNA5-4K
	<b>G</b>	70	ASY	3000	10.000	8.750	125	4	3,20	28208LEDAS3KS
	<b>G</b>	70	ASY	4000	10.000	8.750	125	4	3,20	28208LEDASS
<b>DYNA</b>	<b>G</b>	70	ASY	3000	10.000	8.750	125	4	3,20	75ASYDYNA5-3K
<b>DYNA</b>	<b>G</b>	70	ASY	4000	10.000	8.750	125	4	3,20	75ASYDYNA5-4K
<b>DYNA</b>	<b>G</b>	80	ASY	3000	11.500	10.000	125	4	3,20	100ASYDYNA53K
<b>DYNA</b>	<b>G</b>	80	ASY	4000	11.500	10.000	125	4	3,20	100ASYDYNA54K
	<b>G</b>	100	ASY	3000	14.300	12.500	125	4	3,20	28209/L/AS-3K
	<b>G</b>	100	ASY	4000	14.300	12.500	125	4	3,20	28209/LED/AS

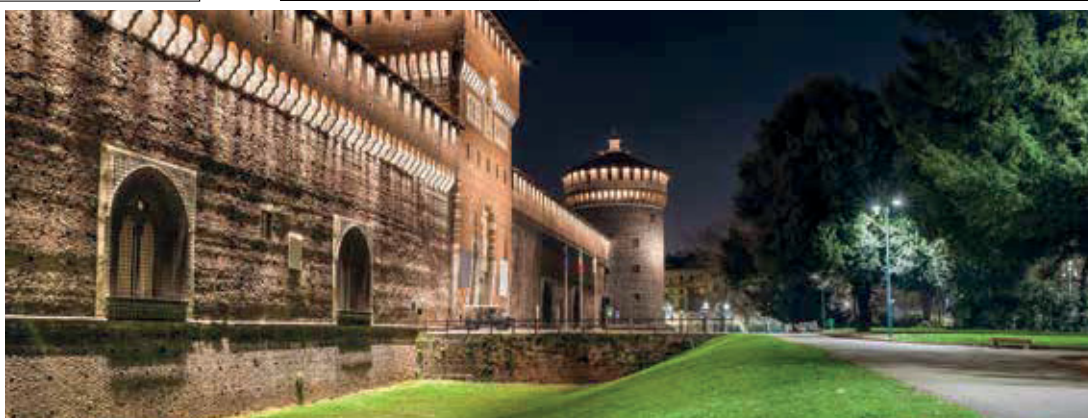

Floodlight

# LED Puma ASY

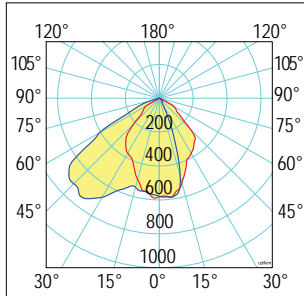

**ASY**  
Asimmetrico - *Asymmetric*

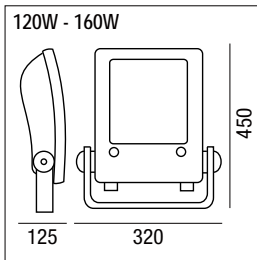
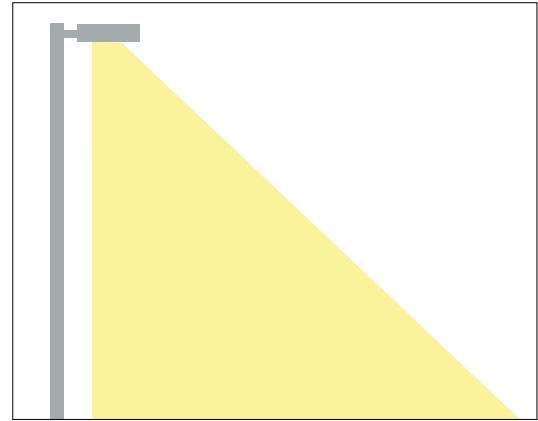

colour	W	angle	K	nominal Im tc = 25°C	Im output	lm/W	pcs	Kg	CELL
<b>DYNA</b> G	120	ASY	3000	19.300	16800	140	2	5,80	28234LEDAS3KS
G	120	ASY	4000	19.300	16800	140	2	5,80	28234LEDASS
<b>DYNA</b> G	120	ASY	3000	19.300	16800	140	2	5,80	28234ASDNA53K
G	120	ASY	4000	19.300	16800	140	2	5,80	28234ASDNA54K
<b>DYNA</b> G	160	ASY	3000	25.700	22400	140	2	6,20	28259LEDAS3K
G	160	ASY	4000	25.700	22400	140	2	6,20	28259LEDAS
<b>DYNA</b> G	160	ASY	3000	25.700	22400	140	2	6,20	28259ASDNA53K
G	160	ASY	4000	25.700	22400	140	2	6,20	28259ASDNA54K

Floodlight

# LED Puma

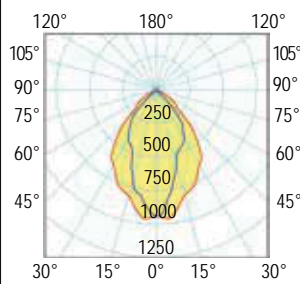

**40°/80°**  
Ovale diffondente - *Oval flood*

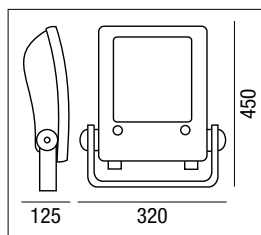
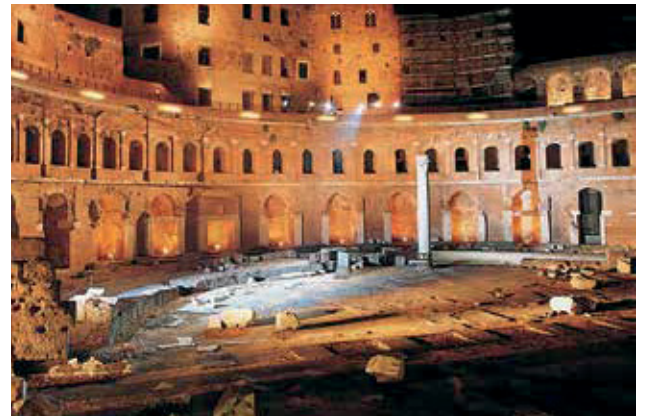

**DALI 2**

colour	W	angle	K	nominal Im tc = 25°C	Im output	lm/W	pcs	Kg	CELL
<b>DALI 2</b> G	120	40/80°	3000	19.300	16.800	140	2	5,80	28234LED803KS
G	120	40/80°	4000	19.300	16.800	140	2	5,80	28234LED80S
<b>DALI 2</b> G	120	40/80°	4000	19.300	16.800	140	2	5,80	28234LED80DA
G	160	40/80°	3000	25.700	22.400	140	2	6,20	28259LED803K
G	160	40/80°	4000	25.700	22.400	140	2	6,20	28259LED80
<b>DALI 2</b> G	160	40/80°	4000	25.700	22.400	140	2	6,20	28259LED80DA



A richiesta LED Puma può essere fornito anche in versione emergenza - + Euro 200,00 da prezzo di listino (aggiungere /E dopo il codice)  
On request, LED Puma can also be supplied in an emergency version - + Euro 200.00 from the list price (add / E after the code)

## LED Maxi Puma ASY

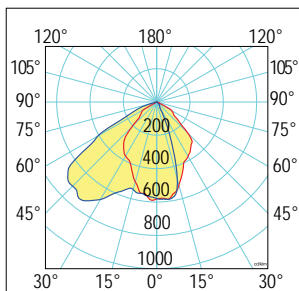

**ASY**  
Asimmetrico - *Asymmetric*

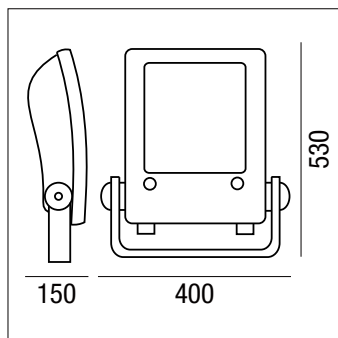
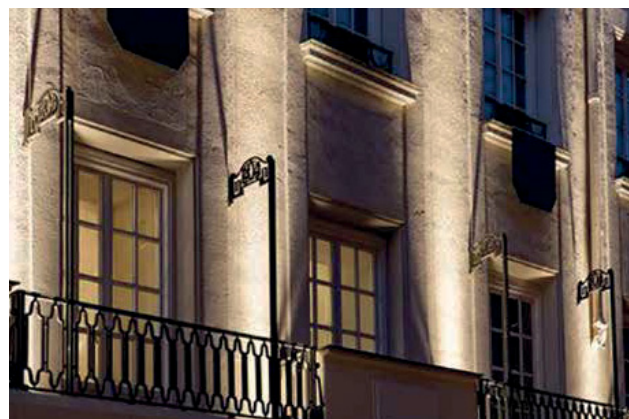

colour	W	angle	K	nominal lm tc = 25°C	lm output	lm/W	pcs	Kg	CELL
G	220	ASY	3000	35.400	30.800	140	2	10,00	28235LEDAS3K
G	220	ASY	4000	35.400	30.800	140	2	10,00	28235LEDAS
1-10Vdc	G	220	ASY	3000	35.400	30.800	2	10,00	28235LEDAS3KS
1-10Vdc	G	220	ASY	4000	35.400	30.800	2	10,00	28235LEDASS
DALI 2	G	220	ASY	3000	35.400	30.800	2	10,00	28235LEDAS3KD
DALI 2	G	220	ASY	4000	35.400	30.800	2	10,00	28235LEDASD



A richiesta LED Puma può essere fornito anche in versione emergenza - + Euro 200,00 da prezzo di listino (aggiungere /E dopo il codice)

*On request, LED Puma can also be supplied in an emergency version - + Euro 200.00 from the list price (add / E after the code)*

## LED Maxi Puma

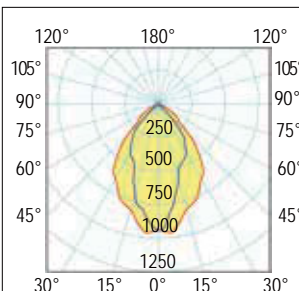

**40°/80°**  
Ovale diffondente - *Oval flood*

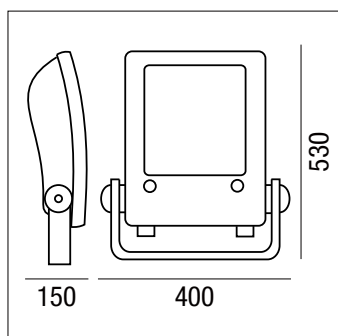
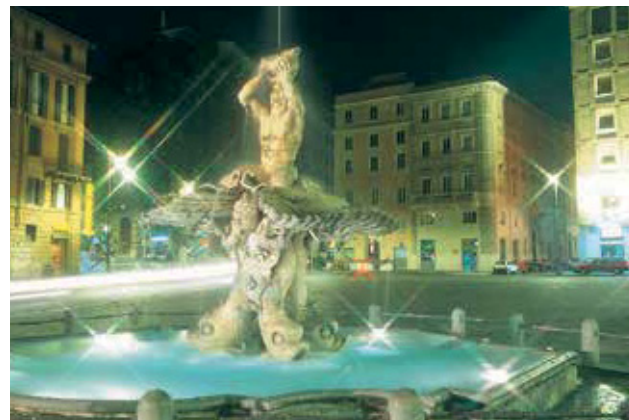

colour	W	angle	K	nominal lm tc = 25°C	lm output	lm/W	pcs	Kg	CELL
G	220	40/80°	3000	35.400	30.800	140	2	10,00	28235LED803K
G	220	40/80°	4000	35.400	30.800	140	2	10,00	28235LED80
1-10Vdc	G	220	40/80°	3000	35.400	30.800	2	10,00	28235LED803KS
1-10Vdc	G	220	40/80°	4000	35.400	30.800	2	10,00	28235LED80S
DALI 2	G	220	40/80°	3000	35.400	30.800	2	10,00	28235LED803KD
DALI 2	G	220	40/80°	4000	35.400	30.800	2	10,00	28235LED80D



A richiesta LED Puma può essere fornito anche in versione emergenza - + Euro 200,00 da prezzo di listino (aggiungere /E dopo il codice)

*On request, LED Puma can also be supplied in an emergency version - + Euro 200.00 from the list price (add / E after the code)*

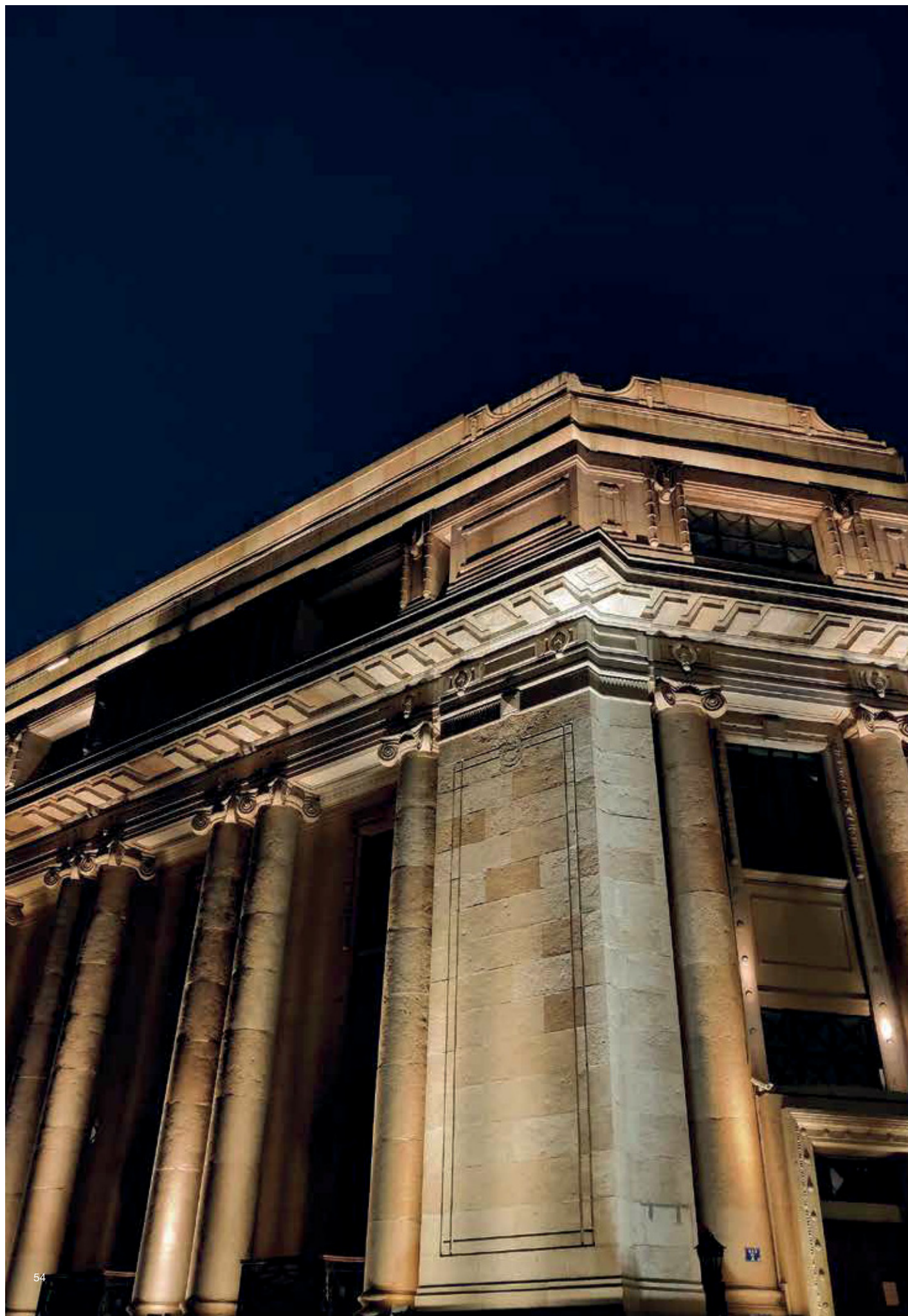

54

# LED Pinguino - LED Puma

## Dettagli - Details

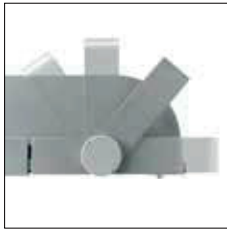

Staffa di fissaggio ruotabile con goniometro. Doppia vite blocca-staffa per resistenza al vento.

*Rotating support with goniometer and double bracket blocking screws against the wind.*

Alette di raffreddamento maggiorate, pressacavo IP66.

*Cooling grilles, IP66 cable gland.*

Dispositivo anticondensa: valvola di compensazione e riciclo dell'aria.

*Anti-condensate device: valve for compensation and circulation of air.*



Tutti i modelli LED Pinguino e LED Puma sono completi di connettore IP68 per una rapida installazione

*All LED Pinguino and LED Puma models are complete with IP68 connector for quick installation*

## Soluzioni NON incluse per aumentare il risparmio energetico NOT included solutions to increase energy saving

Fig. 1 - Esempio applicativo 2 steps  
Application example 2 steps

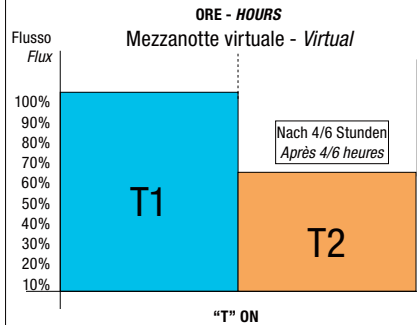

**T1 = 100%** Flusso luminoso  
**T1 = 100%** Luminous flux

**T2 = 70%** Flusso luminoso  
**T2 = 70%** Luminous flux

Minimo tempo di accensione per funzionamento automatico 4 ore (3 giorni).  
Accensioni da 1 a 4 ore oppure superiori alle 23 ore resettano il sistema.

*The minimum ignition time for automatic operation is 4 hours (three days).  
Ignitions 1 hour ignored.  
Switching from 1 to 4 hours or higher with 23 hours reset the system.*

**DYNA CONTROL** è un sistema di controllo del flusso luminoso delle lampade che si basa sul calcolo della mezzanotte virtuale. Il sistema entra in funzione alla prima accensione calcolando per 3 giorni i tempi di accensione. Il quarto giorno il sistema, in modo autonomo, calcola la mezzanotte virtuale eseguendo una regolazione del flusso e regolando la lampada come indicato sullo schema di Fig. 1. La riduzione del flusso luminoso avviene senza la necessità di alcun cavo di connessione aggiuntivo o dispositivo di comando esterno, questo sistema consente di ottenere un notevole risparmio energetico. N.B. su richiesta è possibile eseguire la modifica delle impostazioni di fabbrica della mezzanotte virtuale adattandole alle specifiche del cliente.

**DYNA CONTROL** is a control system for the luminous flux of the lamps which is based on virtual midnight calculation. The system starts running when turned on for the first time, calculating the start-up times for 3 days. On the fourth day, the system automatically calculates the virtual midnight by performing a flux adjustment and adjusting the lamp as indicated on the diagram of Fig. 1. The reduction of the luminous flux occurs without the need for any additional connection cable or external control device. This system can achieve considerable energy saving.

## Accessori non inclusi - Not included accessories



Code: RO0640/N

Dispositivo di protezione conforme alla Norma EN 61547 contro i fenomeni impulsivi atto a proteggere il modulo LED e il relativo alimentatore: classe II fino a 10kV

*Protection device in compliance with the EN 61547 standard to counteract the impulsive phenomena designed to protect the LED module and the relative power supply: class II protection up to 10kV*

### Sovratensioni

Le sovratensioni sono un rapido innalzamento della differenza di potenziale tra le diverse polarità (Fase o Neutro) e la Terra, in alcuni casi sono talmente elevate da superare la soglia di isolamento dei componenti elettronici causandone così il danneggiamento. Esistono anche casi di sovratensioni di entità inferiore, le quali non provocano un immediato guasto dei moduli LED o driver privi di protezione, ma se nel tempo si verificano ripetutamente possono provocare il deterioramento dei LED, di conseguenza, una durata ridotta. Nel caso di sovratensioni di elevata entità, come la caduta dei fulmini, provocano invece un guasto immediato dei moduli LED o dei driver. Le sovratensioni, di fatto, provocano degli impulsi di energia con correnti elevate sia nel driver che nei moduli LED.

### Overvoltages

*Overvoltages are a rapid rise in the potential difference between the different polarities (Phase or Neutral) and the Earth, in some cases they are so high as to exceed the isolation threshold of the electronic components, thus causing damage. There are also cases of minor overvoltages, which do not cause an immediate failure of the unprotected LED modules or drivers, but if they occur repeatedly over time they can cause deterioration of the LEDs, consequently a reduced life span. In the event of high voltage surges, such as lightning strikes, they cause immediate failure of the LED modules or drivers. The overvoltages, in fact, cause energy pulses with high currents in both the driver and the LED modules.*

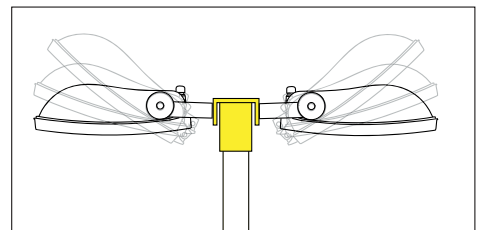
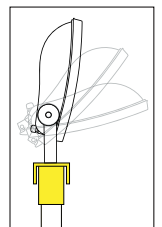

Code: 703952.NEW

Attacco palo per 1 o 2 proiettori, Ø 60/76 mm in ferro verniciato con polveri termoindurenti poliesteri resistenti alla corrosione ed agli agenti atmosferici.

*Pole attachment for either 1 or 2 floodlights, size Ø60/76mm made by iron coated with polyester thermosetting powder, offering high resistance to rust and external atmospheric agents*

# LED Tigre - LED Tigre ASY



Gamma completa di proiettori da esterno ideale per illuminare parcheggi, piazzali, facciate, zone carico-scarico e grandi aree in generale.

**Installazione:** a palo o a parete.

**Corpo e telaio:** in alluminio pressofuso UNI EN 1706 verniciato con polvere termoindurente poliesteri.

**Staffa di fissaggio:** in acciaio, verniciata con polvere termoindurente poliesteri, con goniometro graduato per un corretto puntamento del fascio luminoso.

**Verniciatura:** di tipo poliesteri eseguita a polvere, resistente agli agenti atmosferici, alla corrosione. Grigio RAL 9007.

**Ottica:** semi concentrante, intermedia, semi-diffondente e asimmetrica.

**Schermo:** vetro temprato trasparente di spessore 4mm resistente agli shock termici e agli urti.

**Sorgente:** LED LUMILEDS

Mantenimento del flusso luminoso minimo al 80% - 80.000h (L80B20).

**Temperatura di colore:** 4000K; altre temperature di colore a richiesta (2200K - 2700K - 3000K - 5000K  
Consegna 60 giorni).

**Driver:** incorporato   
Fattore di potenza  $\geq 0,95$ .

**Protezione alle sovratensioni inclusa:**

Modo differenziale 6kV (L-N)

Modo comune 8kV (L-GND, N-GND, L&N-GND)

**A richiesta:** versione con protezione maggiorata (10kV) contro gli impulsi aggiungendo il cod. RO0640/N.

**Norme di riferimento:** IEC 61000-4-5; EN60598-1; EN60598-2-1; EN62471; EN62031; EN60598-2-5; EN61547

*Complete range of outdoor projectors perfect to light up car parks, squares, facades, loading and unloading areas and large areas in general.*

**Installation:** on pole or wall

**Housing and frame:** made by UNI EN 1706 die-cast aluminum, coated with polyester thermoset powder.

**Fixing bracket:** made by stainless steel, coated with polyester thermoset powder, with graduated goniometer to allow the correct orientation of light beam

**Coating:** coated with powdered polyester, resistant to atmospheric agents and corrosion. RAL9007 Grey.

**Optic:** spot, medium, flood and asymmetric.

**Shield:** transparente tempered glass with 4mm thickness resistant to thermal shocks and collisions

**Light source:** LED LUMILEDS

Maintenance of minimum luminous flux to 80% - 80.000h (L80B20).

**Color temperature:** 4000K; other color temperatures available on demand (2200K - 2700K - 3000K - 5000K.  
Delivery time: 60 days)

**Driver:** included   
Power factor  $\geq 0,95$

**Protection against overvoltages included:**

Differential mode 6kV (L-N)

Standard mode 8kV (L - GND, N-GND, L&N-GND).

**Standard reference:** IEC 61000-4-5; EN60598-1; EN60598-2-1; EN62471; EN62031; EN60598-2-5; EN61547



La certificazione fotometrica dei nostri apparecchi viene sempre effettuata da un istituto esterno. Efficienza luminosa e "lm Output" sono quindi il risultato di tale istituto.

*The photometric certification of our appliances is always carried out by an external institute. Luminous efficiency and "lm Output" are therefore the result of this institute.*

A richiesta - On demand

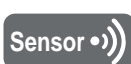

Vedi Pag. VI - See page VI





# LED Tigre - LED Tigre ASY

## Dettagli - Details



Led Driver incorporati nel prodotto.  
 ⚠ Protezione contro gli impulsi 8kV conforme alla Norma EN 61547.  
*Led Driver incorporated in the product.*  
 ⚠ 8kV Impulse protection in accordance with EN 61547.



Dispositivo anticondensa: valvola di compensazione e riciclo dell'aria.  
*Anti-condensate device: valve for compensation and circulation of air.*



Alette di raffreddamento maggiore, pressacavo IP66.  
*Cooling grilles, IP66 cable gland.*



Completo di connettore IP68 per una rapida installazione  
*Complete with IP68 connector for quick installation*

## Accessori non inclusi - Not included accessories



Code: RO0640/N  
 Dispositivo di protezione conforme alla Norma EN 61547 contro i fenomeni impulsivi atto a proteggere il modulo LED e il relativo alimentatore: classe II (a richiesta protezione fino a 10kV)  
*Protection device in compliance with the EN 61547 standard to counteract the impulsive phenomena designed to protect the LED module and the relative power supply: class II (protection up to 10kV available on request)*



Code: 11111  
 Staffa 2x per l'applicazione di due apparecchi - *Bracket for the application of two lighting fixtures*



A richiesta: verniciatura resistente a 2.000 ore di esposizione alla nebbia salina in accordo alla norma ISO 9227 certificato da Ente esterno.  
*On request: painting resistant to 2,000 hours of exposure to salt spray in accordance with ISO 9227 certified by an external body.*



Cod. 703952.NEW  
 Attacco palo per 1 o 2 proiettori, Ø60/76 mm. In ferro verniciato con polveri termoindurenti poliesteri resistenti alla corrosione ed agli agenti atmosferici.  
*Pole attachment for either 1 or 2 floodlights, size Ø 60/76mm. Iron coated with polyester thermosetting powder coating, offering high resistance to rust and external atmospheric agents.*



Predisposto Zhaga Socket per sistemi wireless  
*Prepared for Zhaga Socket for wireless systems*

# BASIC series LED Virgola

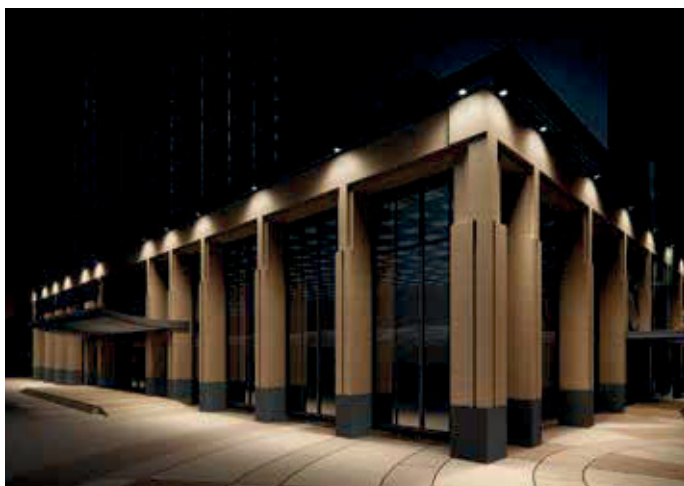

Gamma di proiettori da esterno in alluminio pressofuso ideale per illuminare aree verdi, giardini, parcheggi, piazzali, facciate, zone di carico-scarico e grandi aree in generale.

Installazione: su superfici verticali e orizzontali (completo di staffa di fissaggio) con corpo e telaio in alluminio pressofuso UNI 5076 di tipo poliestere eseguita a polvere, resistente agli agenti atmosferici, alla corrosione e staffa di fissaggio in acciaio, verniciata con polvere termoindurente poliestere.

**Colore:** nero RAL 9004.

**Ottica:** diffondente 120°

**Schermo:** vetro temprato di spessore 4mm resistente agli shock termici e agli urti.

**Sorgente LED SMD:** incorporato con temperatura di colore 4000K; altre temperature di colore a richiesta.

**Driver:** incorporato fattore di potenza:  $\geq 0,9$

Range of outdoor projectors made by die-cast aluminum perfect to light up parks, gardens, car parks, squares, facades, loading and unloading areas and large areas in general.

Installation: on vertical and horizontal surfaces (complete with fixing bracket), with housing and frame made by UNI 5076 die-cast aluminum, coated with powdered polyester, resistant to atmospheric agents and corrosion and fixing bracket made by stainless steel, coated with polyester thermoset powder.

**Color:** RAL 9004 black color.

**Optic:** 120° diffused

**Shield:** tempered glass with 4mm thickness resistant to thermal shocks and collisions

**Light source SMD LED:** included with color temperature 4000K; other color temperatures available on demand.

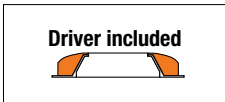
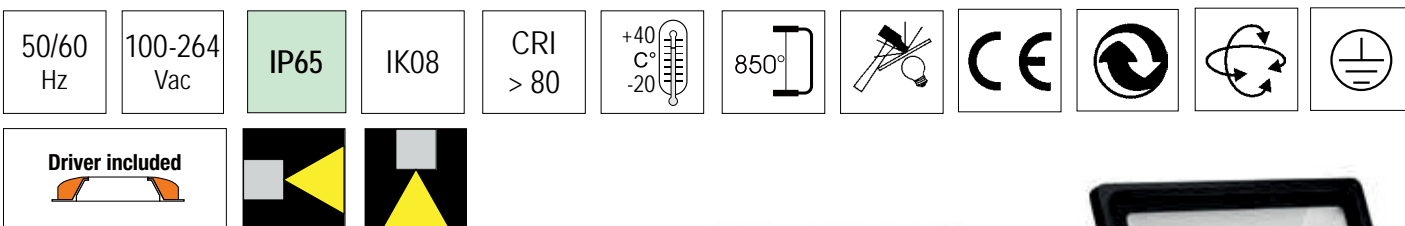

LED Virgola 50W

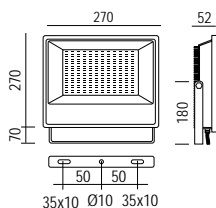

LED Virgola 100W

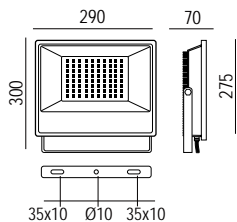

LED Virgola 150W

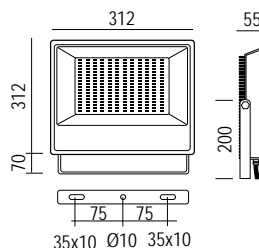

LED Virgola 200W

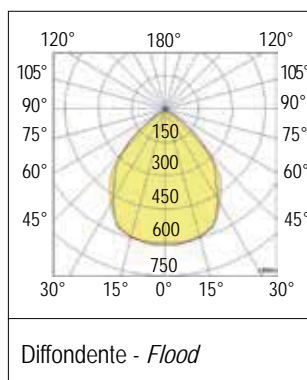
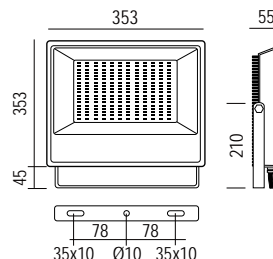

colour	W	angle	K	lm output	lm/W	pcs	Kg	CELL
N	50	120°	4000	5.500	110	1	1,00	27303/NEW
N	100	120°	4000	11.000	110	1	2,10	RL2180362
N	150	120°	4000	16.500	110	1	3,20	RL2180372
N	200	120°	4000	22.000	110	1	3,60	RL2180382

# NEW 2025 LED Virgola 3CCT 3 CCT (3000 / 4000 / 6000K) 3 Power (100 / 150 / 200W) **6 in 1**

## Proiettore industriale

**Corpo:** alluminio pressofuso ADC12

**Colore:** verniciato in polvere termoindurente nero RAL 9005.

**Schermo:** vetro temprato di spessore 5mm resistente agli shock termici e agli urti.

**Trattamento:** verniciatura conforme alla Norme UNI EN ISO 9227

per ambienti aggressivi e nebbie saline

**Ottica:** lenticolare in PMMA ad alta trasmittanza per ottica simmetrica 60° e asimmetrica

**Rischio fotobiologico:** esente illimitato RGO

**Cablaggio:** moduli LED ad alta efficienza

**Fattore di potenza:**  $\geq 0,97$ . Durata utile L90/B10 80.000 h (Tp 25°C)

**Protezione:** alle sovratensioni fino a 6kV con dispositivo conforme alla Norma EN61547

**Driver:** incorporato, idoneo all'utilizzo in impianti d'emergenza centralizzata (EN 60598-2-22).

Prestazioni e flusso indicato al 100% in esecuzione AC e DC (200÷250Vdc).

**Tipo di installazione:** parete

**Standard di alimentazione:** 120-264 - 50/60Hz

**Possibilità di scelta della temperatura colore e della potenza tramite Dip-switch**

## Industrial floodlight

**Body:** die-cast aluminium ADC12

**Color:** coated with RAL 9005 black color polyester thermoset powder.

**Shield:** tempered glass with 5mm thickness resistant to thermal shocks and collisions

**Treatment:** coating compliant with UNI EN ISO 9227 standard for aggressive environments

**Optics:** lens PMMA optic with symmetrical 60° and asymmetrical beam

**Photobiological risk:** exempt unlimited RGO

**Wiring:** high efficiency LED modules

**Power factor:**  $\geq 0,97$ . Lifetime L90/B10 80.000 h (Tp 25°C)

**Protection:** overloads protection up to 6kV with specific device in compliance with EN61547 regulation

**Driver:** included, suitable for centralised emergency installations (EN 60598-2-22).

100% performance in AC or DC use (200Vdc=250Vdc)

**Type of installation:** wall

**Power supply:** 120-264 - 50/60Hz

**With the possibility of choosing the color temperature and power with Dip-switch**

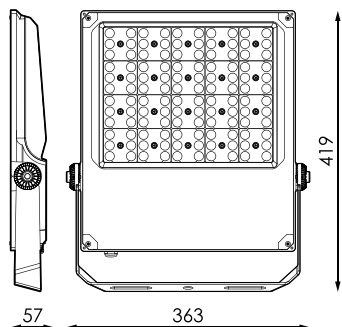
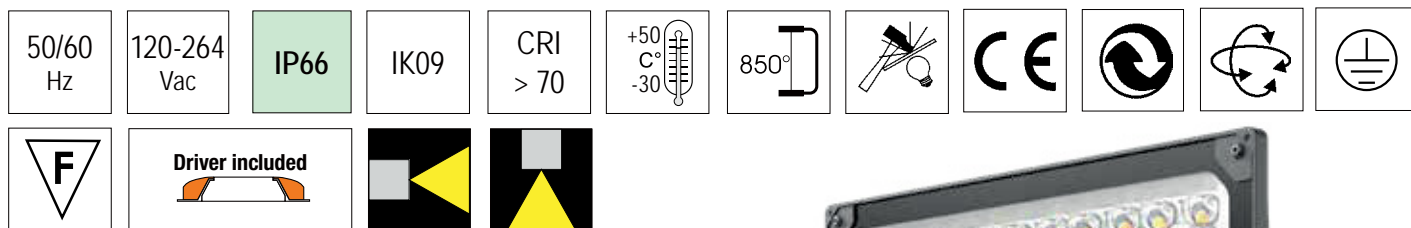

Floodlight



**Dip-switch per la selezione della temperatura di colore**  
**Dip-switch for color Kelvin temperature**

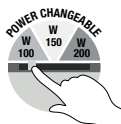

**Dip-switch per la selezione della potenza scelta**  
**Dip-switch for the power choice**

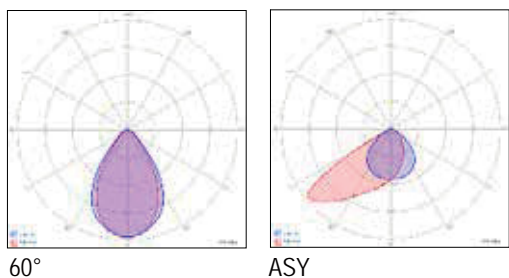
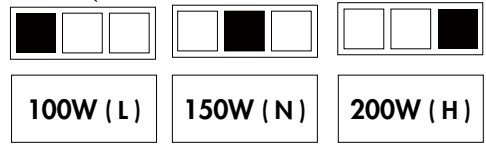

colour	W	angle	K	lm output	lm/W	pcs	Kg	CELL
N	100	60°	3000 / 4000 / 6000	15.000	150	1	1,00	RL21807X1
	150			22.500				
	200			30.000				
N	100	ASY	3000 / 4000 / 6000	14.000	140	1	1,00	RL21807X1AS
	150			21.000				
	200			28.000				

Taratura di fabbrica - Factory setting

Dati riferiti alla versione 4.000K, versione 3.000K -5%, versione 6.000K +5%  
 Data refers to the 4.000K version, 3.000K version -5%, 6.000K version +5%

# LED Panthera - Flood light - Highbay



Gamma completa di proiettori da esterno ideale per illuminare parcheggi, piazzali, facciate, zone carico-scarico, logistiche e grandi aree in generale.

**Installazione:** a palo o a parete.

**Corpo e telaio:** in alluminio pressofuso UNI EN 1706 verniciato con polvere termoindurente poliester.

**Staffa di fissaggio:** in acciaio, verniciata con polvere termoindurente poliester.

**Verniciatura:** di tipo poliester eseguita a polvere, resistente agli agenti atmosferici, alla corrosione. Nero RAL 9005.

**Ottica:** semi concentrante, intermedia e semi-diffondente In PMMA con resistenza alle alte temperature, agli shock termici e agli urti

**Rischio fotobiologico:** IEC 62471 - rischio esente

**Schermo:** vetro temprato trasparente di spessore 4mm resistente agli shock termici e agli urti.

**Sorgente:** LED SMD 5050 LUMILEDS  
Mantenimento del flusso luminoso (L80-B20 > 50.000h).

**Temperatura di colore:** 4000K; altre temperature di colore a richiesta (2200K - 2700K - 3000K. Consegna 60 giorni).

**Driver:** incorporato   
Fattore di potenza  $\geq 0,95$ .

**Protezione alle sovratensioni inclusa:**

Modo differenziale 5kV (L-N)

Modo comune 10kV (L-GND, N-GND, L&N-GND)

**Protezione:** 5/10kV

**Norme di riferimento:** IEC 61000-4-5; EN60598-1; EN60598-2-1; EN62471; EN62031; EN60598-2-5; EN61547

*Complete range of outdoor projectors perfect to light up car parks, squares, facades, loading and unloading areas and large areas in general.*

*Installation: on pole or wall*

*Housing and frame: made by UNI EN 1706 die-cast aluminum, coated with polyester thermoset powder.*

*Fixing bracket: made by stainless steel, coated with polyester thermoset powder.*

*Coating: coated with powdered polyester, resistant to atmospheric agents and corrosion. RAL 9005 Black.*

*Optic: spot, medium and flood.*

*Eyesafety: IEC 62471 - risk exempt*

*Shield: transparente tempered glass with 4mm thickness resistant to thermal shocks and collisions*

*Light source: LED SMD 5050 LUMILEDS*

*Maintenance of minimum luminous flux (L80-B20 > 50.000h).*

*Color temperature: 4000K; other color temperatures available on demand (2200K - 2700K - 3000K . Delivery time: 60 days)*

*Driver: included   
Power factor  $\geq 0,95$*

*Protection: 5/10kV*

*Standard reference: IEC 61000-4-5; EN60598-1; EN60598-2-1; EN62471; EN62031; EN60598-2-5; EN61547*

La certificazione fotometrica dei nostri apparecchi viene sempre effettuata da un istituto esterno. Efficienza luminosa e "lm Output" sono quindi il risultato di tale istituto.

*The photometric certification of our appliances is always carried out by an external institute. Luminous efficiency and "lm Output" are therefore the result of this institute.*

A richiesta - On demand

**DYNA** **DALI 2** **1-10Vdc**

**Wireless** **DMX**

Vedi Pag. VI - See page VI

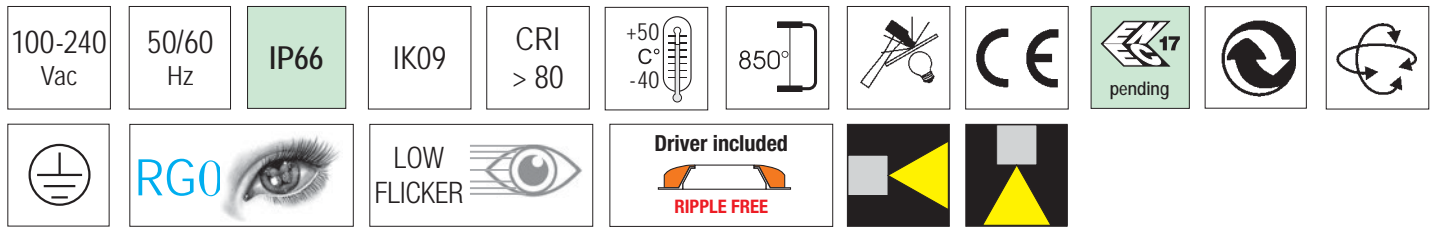

## LED Panthera 1

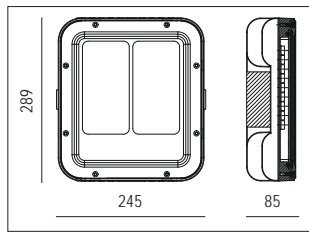
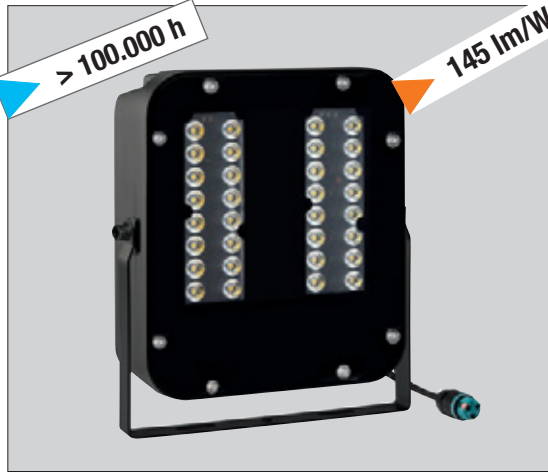

	colour	W	angle	K	nominal Im tc = 25°C	Im output	lm/W	pcs	Kg	CELL
	N	150	ASY 1	4000	26.200	23.200	145	1	4,50	29700
	N	150	35°	4000	26.200	23.200	145	1	4,50	29701
	N	150	90°	4000	26.200	23.200	145	1	4,50	29702
	N	200	ASY 1	4000	32.800	29.000	145	1	4,50	29700-180
	N	200	35°	4000	32.800	29.000	145	1	4,50	29701-180
	N	200	90°	4000	32.800	29.000	145	1	4,50	29702-180
	DALI 2	N	150	ASY 1	4000	26.200	145	1	4,50	29700-DA
	DALI 2	N	150	35°	4000	26.200	145	1	4,50	29701-DA
	DALI 2	N	150	90°	4000	26.200	145	1	4,50	29702-DA
	DALI 2	N	200	ASY 1	4000	32.800	145	145	4,50	29700-180-DA
	DALI 2	N	200	35°	4000	32.800	145	1	4,50	29701-180-DA
	DALI 2	N	200	90°	4000	32.800	145	1	4,50	29702-180-DA

## LED Panthera 2

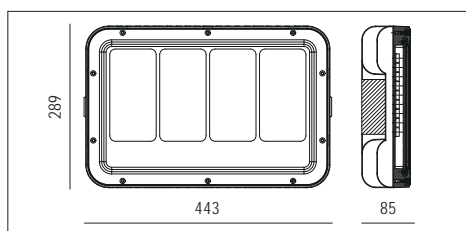
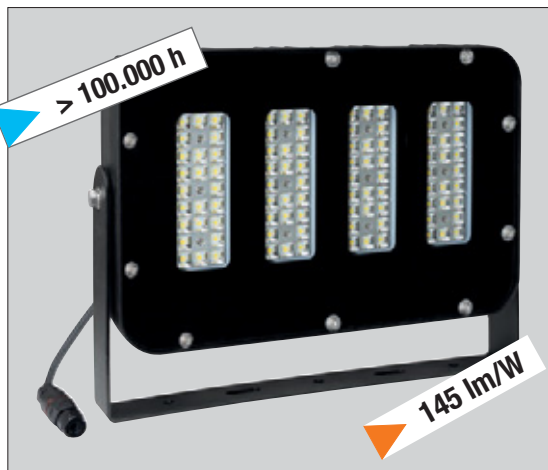

	colour	W	angle	K	nominal Im tc = 25°C	Im output	lm/W	pcs	Kg	CELL
	N	240	ASY 1	4000	34.800	30.300	145	1	9,00	27910
	N	240	35°	4000	34.800	30.300	145	1	9,00	27911
	N	240	90°	4000	34.800	30.300	145	1	9,00	27912
	N	300	ASY 1	4000	52.400	46.400	145	1	9,00	29713
	N	300	35°	4000	52.400	46.400	145	1	9,00	29714
	N	300	90°	4000	52.400	46.400	145	1	9,00	29715
	N	400	ASY 1	4000	65.500	58.000	145	1	10,00	29713-400
	N	400	35°	4000	65.500	58.000	145	1	10,00	29714-400
	N	400	90°	4000	65.500	58.000	145	1	10,00	29715-400
	DALI 2	N	300	ASY 1	4000	52.400	145	1	9,00	29713-DA
	DALI 2	N	300	35°	4000	52.400	145	1	9,00	29714-DA
	DALI 2	N	300	90°	4000	52.400	145	1	9,00	29715-DA
	DALI 2	N	400	ASY 1	4000	65.500	145	1	10,00	29713-400-DA
	DALI 2	N	400	35°	4000	65.500	145	1	10,00	29714-400-DA
	DALI 2	N	400	90°	4000	65.500	145	1	10,00	29715-400-DA

# LED Panthera



Il sistema di dissipazione del calore è realizzato per garantire un perfetto funzionamento dei LED e di conseguenza un'elevata durata di vita.

*The heat dissipation system is designed to ensure perfect operation of the LEDs and consequently a long lifespan.institute.*

Ottiche standard  
Standard optics

Ottiche a richiesta  
On demand optics

Accessorio NON incluso  
NOT included accessory

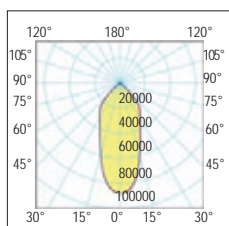

35°  
Concentrante - Concentrating

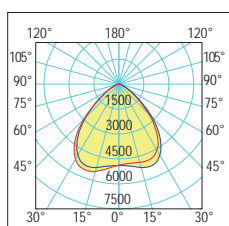

90°  
Diffondente - Wide

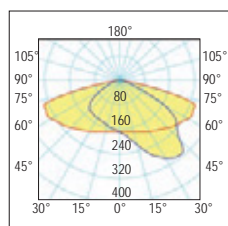

ASY 1  
Asimmetrico - Asymmetric

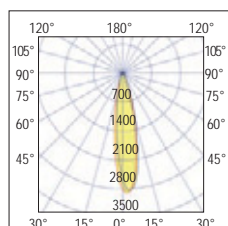

15°  
Super spot

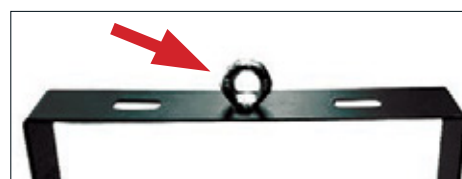

Cod. GFR100.000

Gancio per applicazione a sospensione  
Hook for suspension application

On demand Suspended

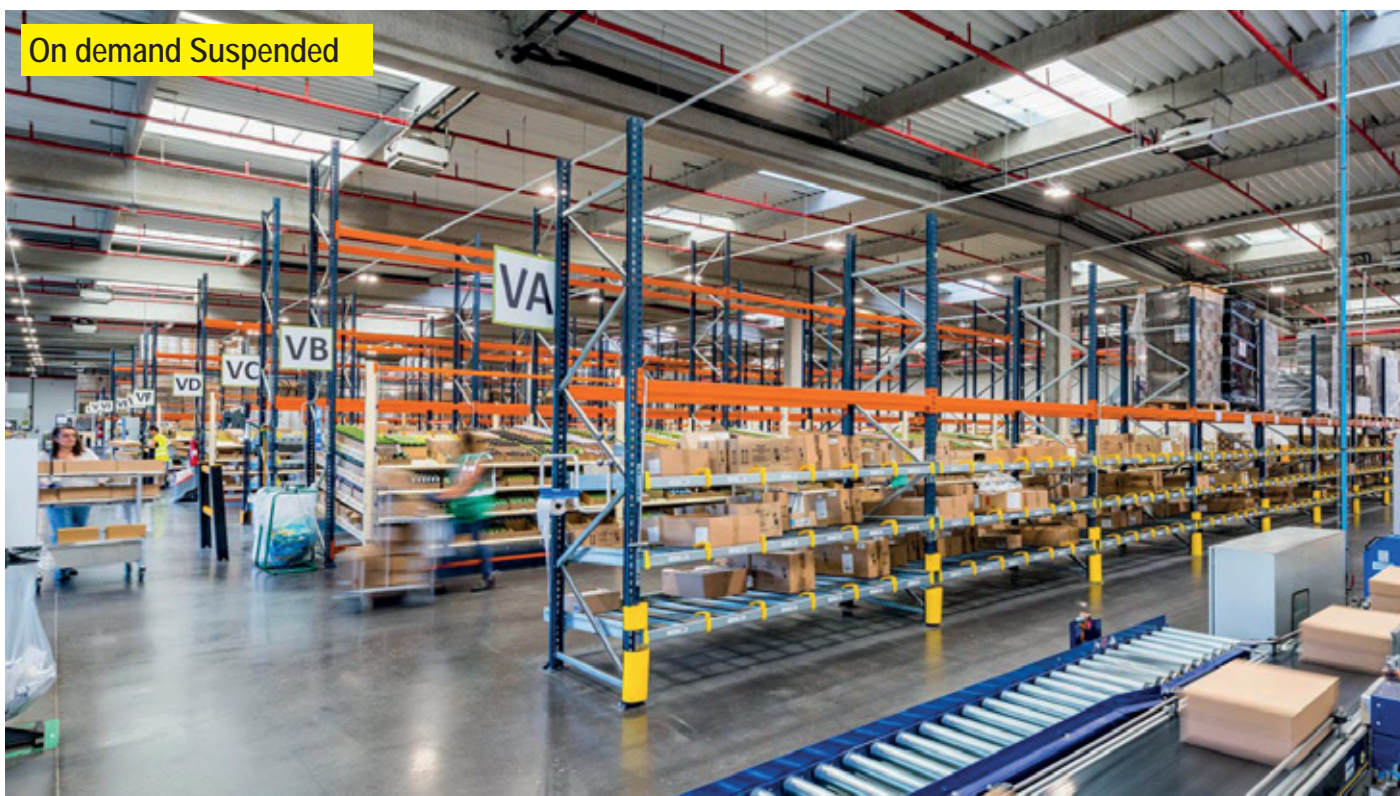



Floodlight

# LED Amalfi - Flood Light 15>54V

**NEW 2026**



Innovativi proiettori a LED da 15 a 54V - 30/60/100/240W

**Corpo e telaio:** in alluminio e acciaio verniciato con polvere termoindurente poliestere.  
**Fissaggio:** 4 punti con viti filetto MA5. Staffa fissaggio a richiesta

**Verniciatura:** di tipo poliestere eseguita a polvere, resistente agli agenti atmosferici e alla corrosione marina. Colore Nero RAL 9005.

**Ottica:** 35° (A richiesta 90°)

**Lenti:** Riflettori in alluminio alta resa luminosa

**Staffa:** in alluminio verniciato con polvere termoindurente poliestere (non inclusa per 30/60/100W) inclusa nel modello 240W.

**Sorgente:** 12 LED SMD 7070. L80-B20>50.000 ore

**Temperatura di colore:** 5000K

**Schermo:** in policarbonato resistente alle alte temperature, agli shock termici e agli urti, guarnizione in silicone

**Norme di riferimento:** IEC 61000-4-5;

EN60598-1; EN60598-2-1; EN62471; EN62031;

EN60598-2-5; EN61547

*Innovative 15V to 54V - 30/60/100/240W LED floodlights*

*Body and frame: Aluminum and steel coated with thermosetting polyester powder.*

*Mounting: 4-point MA5 threaded screws. Mounting bracket available upon request.*

*Painting: Polyester powder coating, resistant to atmospheric agents and marine corrosion. Color: Black RAL 9005.*

*Optics: 35° (90° upon request)*

*Lenses: High-efficiency aluminum reflectors*

*Bracket: in aluminium painted with thermosetting polyester powder (not included for 30/60/100W) included in the 240W model.*

*Light source: 12 SMD 7070 LEDs. L80-B20 > 50,000 hours*

*Color temperature: 5000K*

*Display: Polycarbonate resistant to high temperatures, thermal shock, and impacts, silicone gasket*

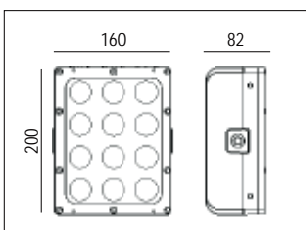

Cod. **FE-00192-N**  
Staffa da ordinare a parte per i modelli 30/60/100W.

Bracket to be ordered separately for 30/60/100W models.



colour	W	angle	K	Vdc	lm output	Kg	Cod.
N	30	35°	5000	15÷54	3600	2,60	AMA3024*
N	60	35°	5000	15÷54	7200	2,60	AMA6024*
N	100	35°	5000	15÷54	12.000	2,60	AMA10024*
N	240	35°	5000	15÷54	28.800	6	AMA240RV24*
N	240	35°	5000	15÷54	28.800	6	AMA240QO24*

\* A richiesta con tensione 48V. - On request 48V. tension

## Ottica standard Standard optic

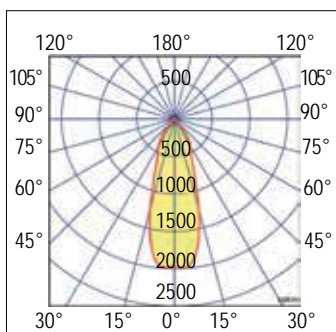

**35°**

Ottica concentrante  
Concentrating optics



# LED Amalfi Doppio - Double

LED Amalfi  
240W RV

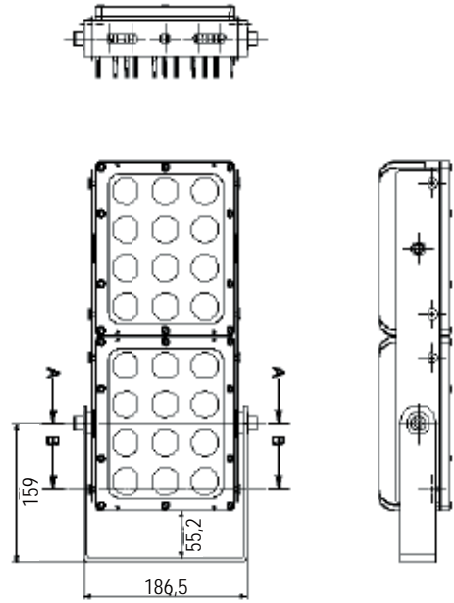

LED Amalfi  
240W QO

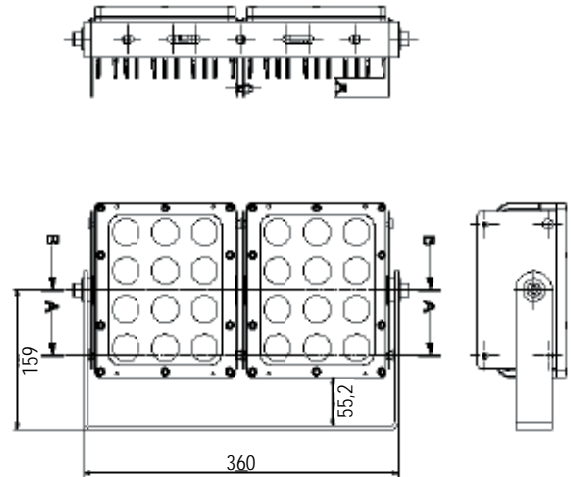

Gamma completa di proiettori da esterno ideale per illuminare parcheggi, piazzali, facciate, zone carico-scarico, logistiche e grandi aree in generale.

**Installazione:** a palo o a parete.

**Corpo e telaio:** in alluminio pressofuso UNI EN 1706 verniciato con polvere termoisolante poliestere.

**Staffa di fissaggio:** in acciaio, verniciata con polvere termoisolante poliestere.

**Verniciatura:** di tipo poliestere eseguita a polvere, resistente agli agenti atmosferici, alla corrosione. Nero RAL 9005.

**Ottica:** lente IP66 semi concentrante e semi-diffondente. In PMMA con resistenza alle alte temperature, agli shock termici e agli urti. Guarnizione in silicone.

**Rischio fotobiologico:** IEC 62471 - rischio esente

**Sorgente:** LED SMD 5050 LUMILEDS  
Mantenimento del flusso luminoso (L80-B20 > 50.000h).

**Temperatura di colore:** 4000K; altre temperature di colore a richiesta (2200K - 2700K - 3000K - 5000K  
Consegna 60 giorni).

**Driver:** incorporato   
Fattore di potenza  $\geq 0,95$ .

**Protezione alle sovratensioni inclusa:**

Modo differenziale 5kV (L-N)

Modo comune 10kV (L-GND, N-GND, L&N-GND)

**Protezione:** 5/10kV

**Norme di riferimento:** IEC 61000-4-5; EN60598-1; EN60598-2-1; EN62471; EN62031; EN60598-2-5; EN61547

*Complete range of outdoor projectors perfect to light up car parks, squares, facades, loading and unloading areas and large areas in general.*

*Installation: on pole or wall*

*Housing and frame: made by UNI EN 1706 die-cast aluminum, coated with polyester thermoset powder.*

*Fixing bracket: made by stainless steel, coated with polyester thermoset powder.*

*Coating: coated with powdered polyester, resistant to atmospheric agents and corrosion. RAL 9005 Black.*

*Optic: IP66 semi-concentrating and semi-diffusion lens in PMMA with resistance to high temperatures, thermal shocks and impacts. Silicone gasket.*

*Eyesafety: IEC 62471 - risk exempt*

*Light source: LED SMD 5050 LUMILEDS  
Maintenance of minimum luminous flux (L80-B20 > 50.000h).*

*Color temperature: 4000K; other color temperatures available on demand (2200K - 2700K - 3000K - 5000K.  
Delivery time: 60 days)*

*Driver: included   
Power factor  $\geq 0,95$*

*Protection: 5/10kV*

*Standard reference: IEC 61000-4-5; EN60598-1; EN60598-2-1; EN62471; EN62031; EN60598-2-5; EN61547*

100-240 Vac	50/60 Hz	<b>IP67</b>	IK09	CRI > 80	+50°C -40°C	850°		<b>CE</b>	pending		
	<b>RG0</b>	LOW FLICKER	<b>Driver included</b>	<b>RIPPLE FREE</b>							

## LED Leo

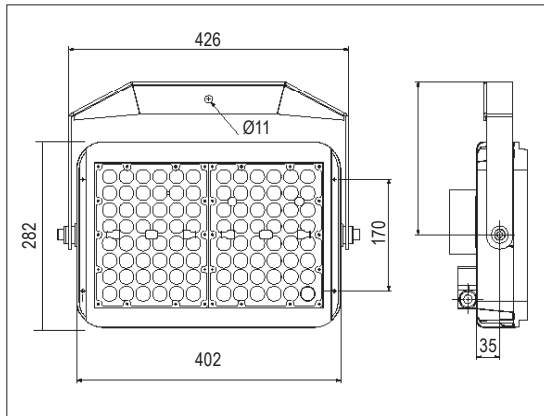

colour	W	angle	K	nominal lm tc = 25°C	lm output	lm/W	pcs	Kg	CELL
N	150	35°	4000	26.700	23.250	155	1	8,00	LEO150354K
N	150	90°	4000	26.700	23.250	155	1	8,00	LEO150904K
N	150	35°	5700	26.700	23.250	155	1	8,00	LEO1503555K
N	240	35°	4000	42.000	37.200	155	1	9,50	LEO240354K
N	240	90°	4000	42.000	37.200	155	1	9,50	LEO240904K
N	240	35°	5700	42.000	37.200	155	1	9,50	LEO2403555K
N	300	35°	4000	54.000	46.500	155	1	10,00	LEO320354K
N	300	90°	4000	54.000	46.500	155	1	10,00	LEO320904K
N	300	35°	5700	54.000	46.500	155	1	10,00	LEO320355K
<b>DALI 2</b>	N	240	35°	4000	42.000	155	1	9,50	LEO240354KDA
<b>DALI 2</b>	N	240	90°	4000	42.000	155	1	9,50	LEO240904KDA
<b>DALI 2</b>	N	300	35°	4000	54.000	155	1	10,00	LEO320354KDA
<b>DALI 2</b>	N	300	90°	4000	54.000	155	1	10,00	LEO320904KDA

### Ottiche standard - Standard optics

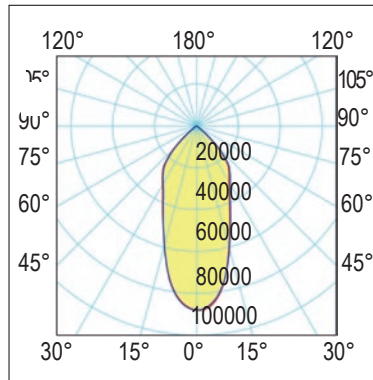

**35°**  
Concentrate - Concentrating

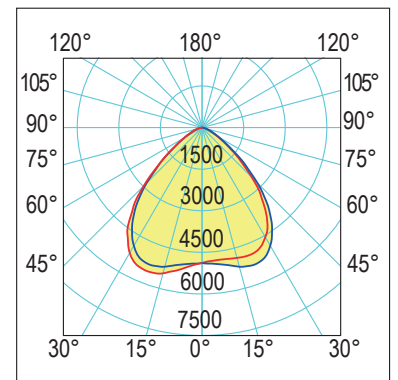

**90°**  
Diffidente - Wide

### Accessori non inclusi - Not included accessories



**Code:** LEOSTAFFA  
Staffa orientabile SAGOMATA per montaggio a parete completa di vite e rondella niylon.  
*SHAPED adjustable bracket for wall mounting complete with screw and nylon washer.*



**Code:** LEOSTAFFAECO  
Staffa orientabile per montaggio a parete, completa di vite e rondella niylon.  
*Swivel bracket for wall mounting, complete with screw and nylon washer.*



**Code:** LEOSCHERMOOP  
Schermo antiabbagliamento in policarbonato opale  
*Opal polycarbonate anti-glare screen*

# LED Milano Sport



La certificazione fotometrica dei nostri apparecchi viene sempre effettuata da un istituto esterno. Efficienza luminosa e "Im Output" sono quindi il risultato di tale istituto.

*The photometric certification of our appliances is always carried out by an external institute. Luminous efficiency and "Im Output" are therefore the result of this institute.*

A richiesta - On demand



Vedi Pag. VI - See page VI

Il LED Milano Sport è un proiettore per l'illuminazione di stadi e strutture sportive, grandi infrastrutture (aeroporti, stazioni, ecc.), aree di parcheggio, zone di stoccaggio (industriali, portuali, ecc.).

La particolare forma permette di avere diverse potenze e fasci luminosi stretti e precisi, specifici per l'installazione a notevole altezza. La qualità delle parti elettroniche e del corpo lampada e dei materiali assicurano sicurezza in fase di esercizio nelle condizioni ambientali più critiche.

**Installazione:** su palo o a parete

**Corpo e telaio:** alluminio pressofuso

**Staffa di fissaggio:** in acciaio zincato a caldo, con goniometro graduato per un corretto puntamento del fascio luminoso

**Verniciatura:** speciale eseguita a polvere, resistente agli agenti atmosferici e alla corrosione e alle nebbie. Colore Grigio RAL 9007.

**Ottica:** in polycarbonato metallizzato

**Schermo:** vetro temperato ultra-white resistente agli shock termici e agli urti h 4mm

**Sorgente:** LED LUMILEDS 5050  
Mantenimento del flusso luminoso minimo al 70%: 80.000h (L70B20) per l'80% dei LED.

**Temperatura di colore:** 5700K (CRI 90) specifica per gli impianti con riprese televisive o 4000K (CRI 80);

**Driver LED multipotenza DALI 2:**

Certificato

**Fattore di potenza:**  $\geq 0,95$

Wide range 100÷277V

**Surge protection:**

common mode 10kV

differential mode 6kV

**Norme di riferimento**

EN60598-1; EN60598-2-1; EN62471; EN62031

EN60598-2-5; EN61547

*LED Milano Sport is a projector for indoor and outdoor stadiums and sports grounds, large infrastructures (airports, stations, etc.), parking areas and storage areas (on industrial premises, at ports, etc.).*

*Different light intensities and narrow and precise light beams are possible due to the special design of the lamp body and light source, specifically for installation at a considerable height. The quality of the electronic parts, lamp body and materials ensure operating safety under even the most critical of environmental conditions.*

**Installation:** on pole or wall

**Housing and frame:** die-cast aluminium

**Fitting stirrup:** in hot galvanised steel with graduated goniometer for correct pointing of the light beam

**Painting:** special powder coating, resistant to atmospheric agents, corrosion and mists. Grey RAL 9007.

**Optics:** concentrator and asymmetric optics

**Screen:** ultra-white thermal shock and collision resistant tempered glass.

**Source:** LED LUMILEDS 5050

Maintenance of 70% minimum luminous flux: 80,000h (L70B20) for 80% of the LEDs.

**Color temperature:** 5700K (CRI 90) specific for systems with television footage or 4000K (CRI 80);

**Driver LED multipower DALI 2:**

Certified

**Power factor:**  $\geq 0,95$

Wide range: 100÷277V

**Surge protection:**

common mode 10kV

differential mode 6kV

**Standard reference**

EN60598-1; EN60598-2-1; EN62471; EN62031

EN60598-2-5; EN61547

# LED Milano Sport



Floodlight

# LED Milano Sport



Floodlight



100-277 Vac	50/60 Hz	IP66	IK08	+50 C -20	850°		CE			
RG0	LOW FLICKER	Driver included  RIPPLE FREE					EMC IMO Tested			

## LED Milano Sport 1

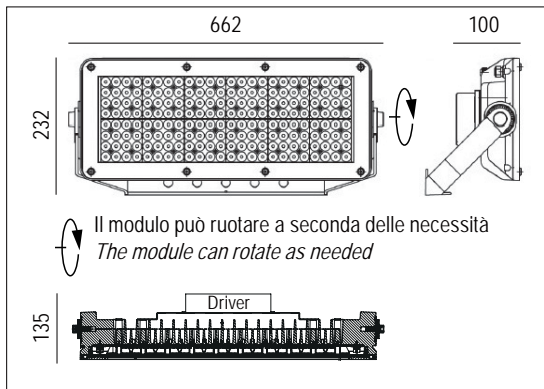

	colour	W	angle	K	CRI	nominal Im tc = 25°C	Im output	lm/W	pcs	Kg	CELL
DALI 2	G	400	15°	4000	80	65.500	58.000	145	1	11,00	MI-400-15-4K
DALI 2	G	400	25°	4000	80	65.500	58.000	145	1	11,00	MI-400-25-4K
DALI 2	G	400	40°	4000	80	65.500	58.000	145	1	11,00	MI-400-40-4K
DALI 2	G	400	ASY	4000	80	65.500	58.000	145	1	11,00	MI-400-ASY-4K
DALI 2	G	400	15°	5700	80	65.500	58.000	145	1	11,00	MI-400-15-5K
DALI 2	G	400	25°	5700	80	65.500	58.000	145	1	11,00	MI-400-25-5K
DALI 2	G	400	40°	5700	80	65.500	58.000	145	1	11,00	MI-400-40-5K
DALI 2	G	400	ASY	5700	80	65.500	58.000	145	1	11,00	MI-400-ASY-5K

A richiesta: disponibilità di varie ottiche - On request: availability of various optics

## LED Milano Sport 2



	colour	W	angle	K	CRI	nominal Im tc = 25°C	Im output	lm/W	pcs	Kg	CELL
DALI 2	G	600	15°	4000	80	98.300	87.000	145	1	25,00	MI-600-15-4K
DALI 2	G	600	25°	4000	80	98.300	87.000	145	1	25,00	MI-600-25-4K
DALI 2	G	600	40°	4000	80	98.300	87.000	145	1	25,00	MI-600-40-4K
DALI 2	G	600	ASY	4000	80	98.300	87.000	145	1	25,00	MI80ASY4K600W
DALI 2	G	600	15°	5700	80	98.300	87.000	145	1	25,00	MI-600-15-5K
DALI 2	G	600	25°	5700	80	98.300	87.000	145	1	25,00	MI-600-25-5K
DALI 2	G	600	40°	5700	80	98.300	87.000	145	1	25,00	MI-600-40-5K
DALI 2	G	600	ASY	5700	80	98.300	87.000	145	1	25,00	MI-600-ASY-5K
DALI 2	G	800	15°	4000	80	131.000	116.000	145	1	25,00	MI-800-15-4K
DALI 2	G	800	25°	4000	80	131.000	116.000	145	1	25,00	MI-800-25-4K
DALI 2	G	800	40°	4000	80	131.000	116.000	145	1	25,00	MI-800-40-4K
DALI 2	G	800	ASY	4000	80	131.000	116.000	145	1	25,00	MI-800-ASY-4K
DALI 2	G	800	15°	5700	80	131.000	116.000	145	1	25,00	MI-800-15-5K
DALI 2	G	800	25°	5700	80	131.000	116.000	145	1	25,00	MI-800-25-5K
DALI 2	G	800	40°	5700	80	131.000	116.000	145	1	25,00	MI-800-40-5K
DALI 2	G	800	ASY	5700	80	131.000	116.000	145	1	25,00	MI-800-ASY-5K

A richiesta: disponibilità di varie ottiche - On request: availability of various optics

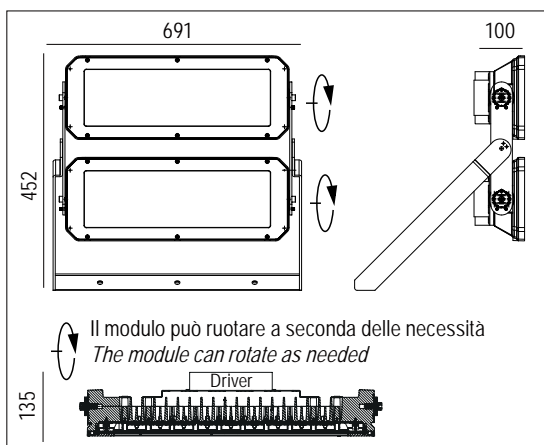

# LED Milano Sport 3

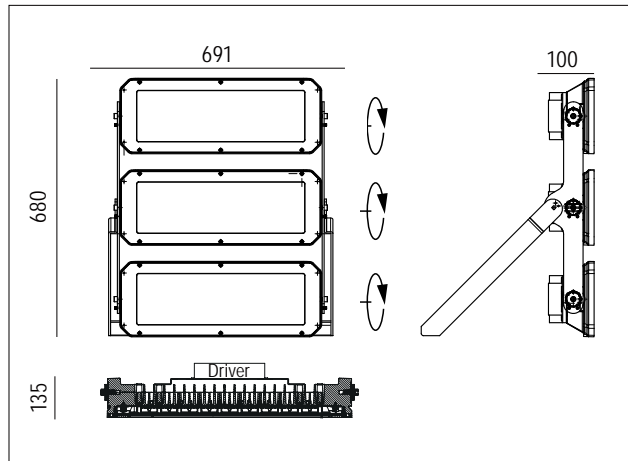

	colour	W	angle	K	CRI	nominal lm tc = 25°C	lm output	lm/W	pcs	Kg	CELL
<b>DALI 2</b>	G	1.200	15°	4000	80	196.600	174.000	145	1	42,00	MI-1200-154K
<b>DALI 2</b>	G	1.200	25°	4000	80	196.600	174.000	145	1	42,00	MI-1200-254K
<b>DALI 2</b>	G	1.200	40°	4000	80	196.600	174.000	145	1	42,00	MI-1200-404K
<b>DALI 2</b>	G	1.200	ASY	4000	80	196.600	174.000	145	1	42,00	MI-1200-ASY4K
<b>DALI 2</b>	G	1.200	15°	5700	80	196.600	174.000	145	1	42,00	MI-1200-155K
<b>DALI 2</b>	G	1.200	25°	5700	80	196.600	174.000	145	1	42,00	MI-1200-255K
<b>DALI 2</b>	G	1.200	40°	5700	80	196.600	174.000	145	1	42,00	MI-1200-405K
<b>DALI 2</b>	G	1.200	ASY	5700	80	196.600	174.000	145	1	42,00	MI-1200-ASY5K

A richiesta: disponibilità di varie ottiche  
On request: availability of various optics

Floodlight

# LED Milano Sport 4

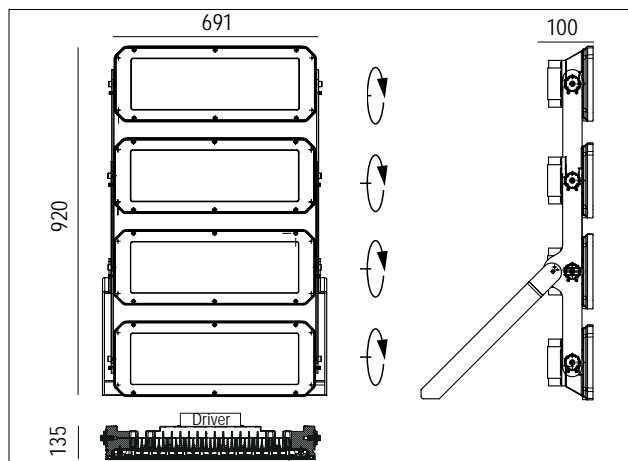
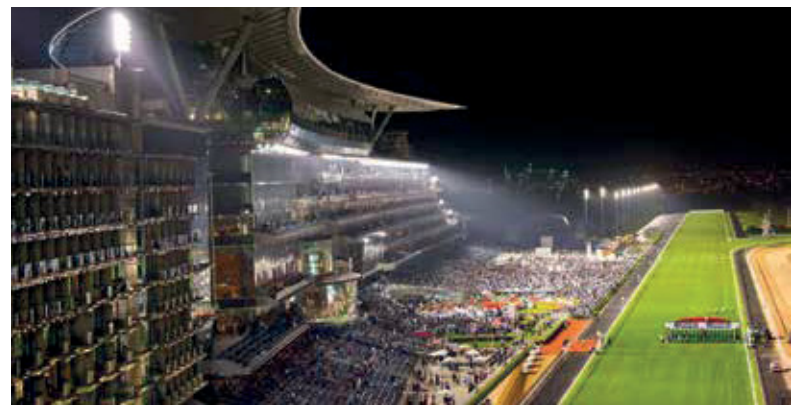

	colour	W	angle	K	CRI	nominal lm tc = 25°C	lm output	lm/W	pcs	Kg	CELL
<b>DALI 2</b>	G	1.600	15°	4000	80	255.200	232.000	145	1	57,00	MI-1600-154K
<b>DALI 2</b>	G	1.600	25°	4000	80	255.200	232.000	145	1	57,00	MI-1600-254K
<b>DALI 2</b>	G	1.600	40°	4000	80	255.200	232.000	145	1	57,00	MI-1600-404K
<b>DALI 2</b>	G	1.600	ASY	4000	80	255.200	232.000	145	1	57,00	MI-1600-ASY4K
<b>DALI 2</b>	G	1.600	15°	5700	80	255.200	232.000	145	1	57,00	MI-1600-155K
<b>DALI 2</b>	G	1.600	25°	5700	80	255.200	232.000	145	1	57,00	MI-1600-255K
<b>DALI 2</b>	G	1.600	40°	5700	80	255.200	232.000	145	1	57,00	MI-1600-405K
<b>DALI 2</b>	G	1.600	ASY	5700	80	255.200	232.000	145	1	57,00	MI-1600-ASY5K

A richiesta: disponibilità di varie ottiche  
On request: availability of various optics

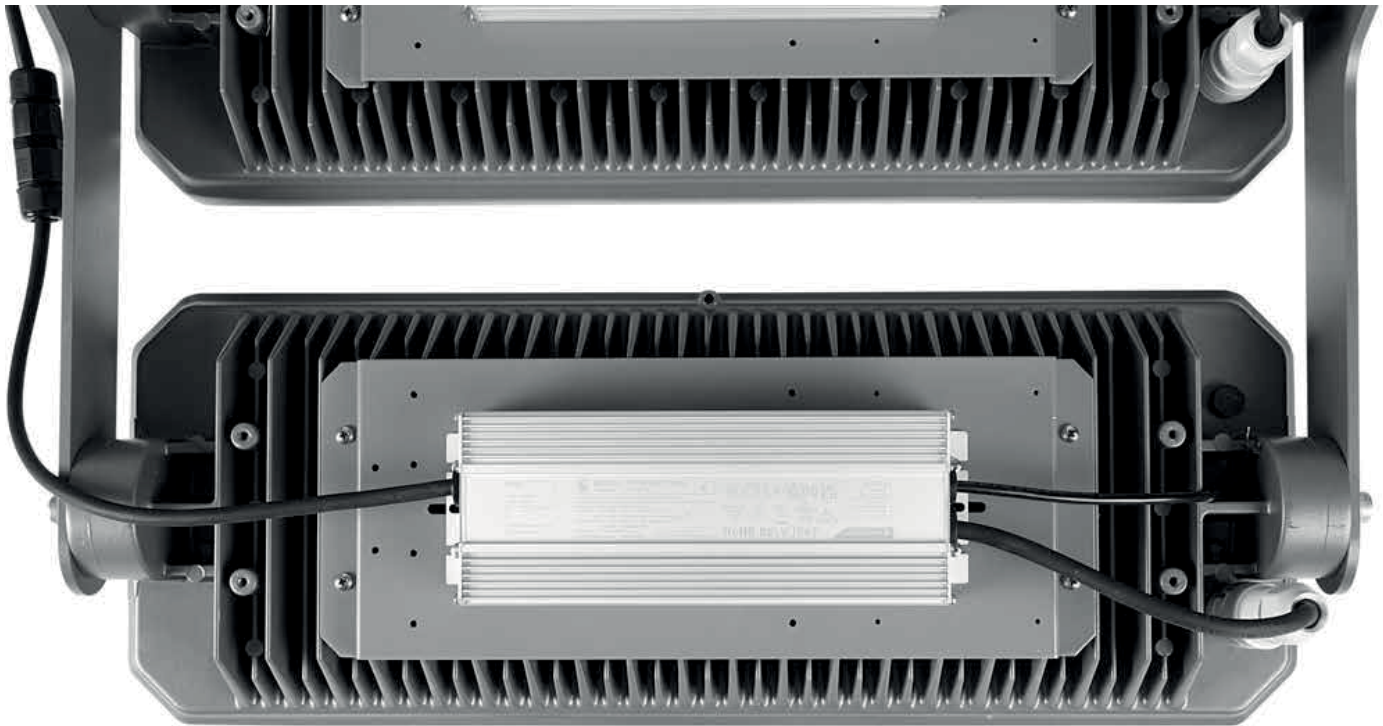

Il sistema di dissipazione del calore è appositamente realizzato per permettere il funzionamento dei LED con temperature idonee e garantire ottime prestazioni/rendimento ed un'elevata durata.

*The heat dissipation system is designed to permit use of the LEDs at suitable temperatures and to guarantee excellent efficiency/performance and a long lifespan.*

## Ottiche di serie - Standard optics

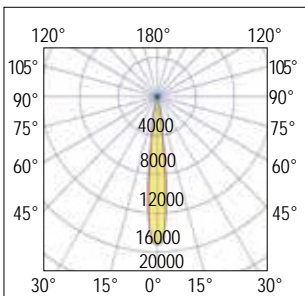

**15°** - Super spot

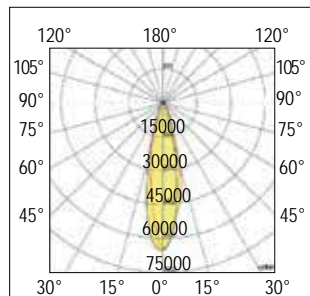

**25°**  
Concentrante - Spot

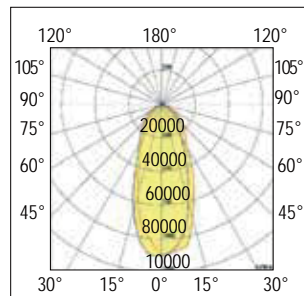

**40°** - Semi-diffondente - Wide

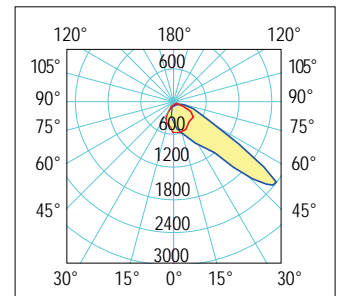

**ASY**  
Asimmetrico - Asymmetric

## Applicazioni - Applications

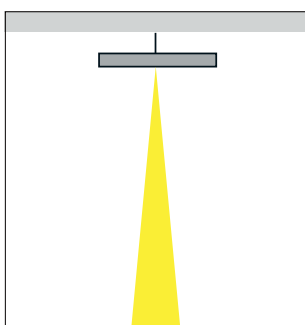

**15°** Super spot

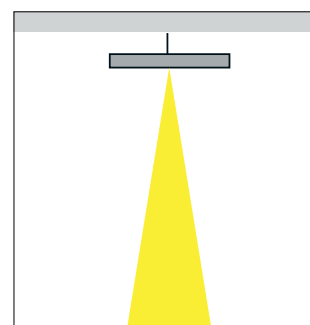

**25°** Concentrante - Spot

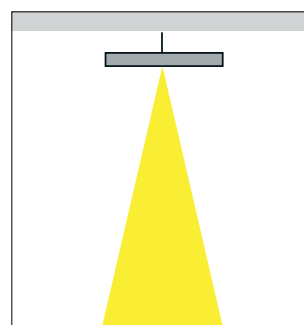

**40°** Semi-diffondente - Wide

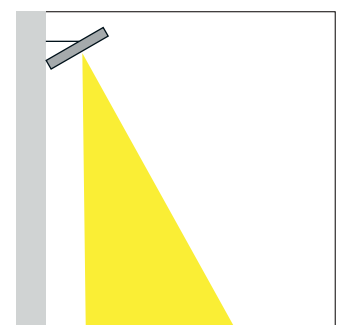

**ASY** Asimmetrico - Asymmetric



# LED Lampo serie - Flood light - Highbay

180 lm/W



A richiesta - On demand



Vedi Pag. VI - See page VI

Innovativi proiettori a LED progettati per illuminare campi sportivi, stadi, aree di parcheggio, aeroporti, logistiche e grandi aree in genere.

**Installazione:** sospensione, parete/plafone e testa palo (completo di staffa di fissaggio).

**Corpo e telaio:** in alluminio e acciaio verniciato con polvere termoindurente poliestere.

**Staffa di fissaggio:** in acciaio, verniciata con polvere termoindurente poliestere

**Verniciatura:** di tipo poliestere eseguita a polvere, resistente agli agenti atmosferici e alla corrosione marina. Colore Grigio RAL 9007.

**Ottica:** concentrante, semi concentrante, diffondente e asimmetrica.

**Lenti:** PMMA autoestinguenti antiurto

**Sorgente:** LED SMD 5050

**Temperatura di colore:** 4000K; a richiesta (2200K - 2700K - 3000K - 5000K - Consegna 90 giorni).

**Protezione alle sovratensioni inclusa:**

Modo differenziale 6kV (L-N)

Modo comune 10kV (L-GND, N-GND, L&N-GND)

Mantenimento del flusso luminoso minimo al 80% - 50.000h (L80B10) per il 90% dei LED.

**LED Driver:** 

Conforme alla Norma: IEC 61000-4-5.

Fattore di potenza:  $\geq 0,98$

**Norme di riferimento:** IEC 61000-4-5;

EN60598-1; EN60598-2-1; EN62471; EN62031;

EN60598-2-5; EN61547

*Innovative LED projectors designed to light up sport fields, stadiums, car parks, airports and wide spaces in general.*

**Installation:** on vertical and horizontal surfaces (complete with fixing bracket)

**Housing and frame:** made by UNI EN 1706 die-cast aluminum, coated with polyester thermoset powder.

**Fixing bracket:** made by stainless steel, coated with polyester thermoset powder, with graduated goniometer to allow the correct orientation of light beam

**Coating:** coated with powdered polyester, resistant to atmospheric agents and marine corrosion. Grey colour RAL 9007

**Optic:** clumping, semi-clumping, diffused and asymmetric

**Shield:** tempered glass with 4mm thickness resistant to thermal shocks and collisions

**Light source:** LED **SAMSUNG**

**Color temperature:** 4000K; on demand (2200K - 2700K - 3000K - 5000K. Delivery time: 90 days)

**Protection against overvoltages included:**

Differential mode 6kV (L-N)

Standard mode 10kV (L - GND, N-GND, L&N-GND).

Maintenance of minimum luminous flux to 80% - 50.000h (L80B10) for 90% of LED.

**LED Driver:** 

Conforming to IEC 61000-4-5.

Power factor:  $\geq 0,98$

**Standard reference:** IEC 61000-4-5; EN60598-1;

EN60598-2-1; EN62471; EN62031; EN60598-2-5;

EN61547

## LED Lampo serie

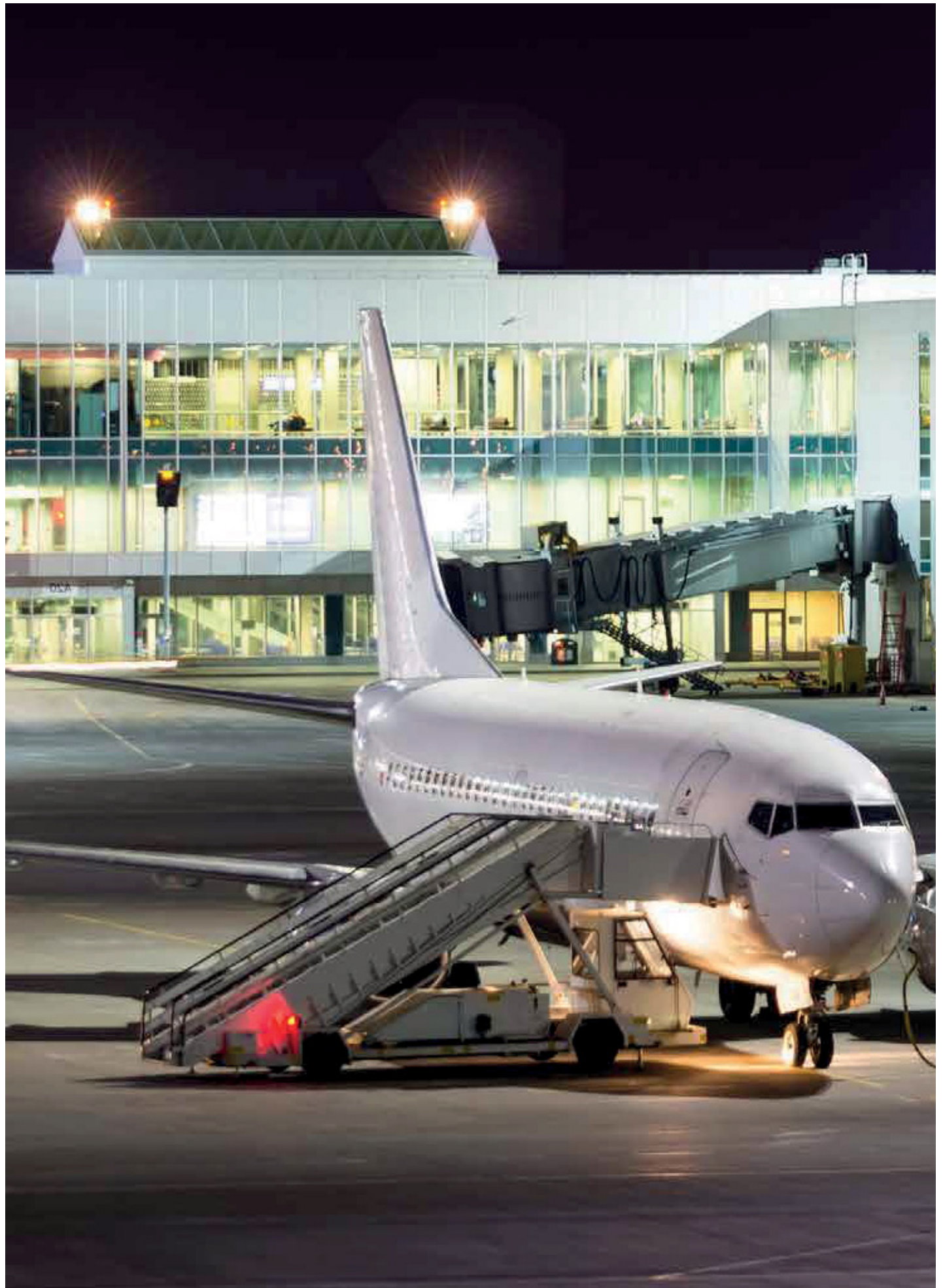

100-240 Vac	110 Vac On demand	50/60 Hz	IP66	IK10	CRI > 80	+40 °C -40	850°				CE
	RG0	LOW FLICKER	Driver included  RIPPLE FREE								

## LED Lampo 2

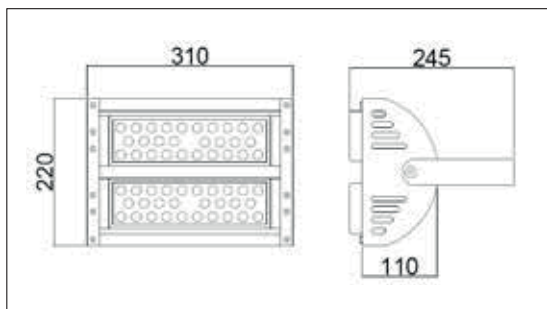

colour	W	angle	K	nominal lm tc = 25°C	lm output	lm/W	pcs	Kg	CELL
G	120	25°	4000	24.400	21.600	180	1	2,90	RFL120254K
G	120	40°	4000	24.400	21.600	180	1	2,90	RFL120404K
G	120	60°	4000	24.400	21.600	180	1	2,90	RFL120604K
G	120	60°	3000	24.400	21.600	180	1	2,90	RFL120603K
G	120	ASY	4000	24.400	21.600	180	1	2,90	RFL120ASY4K

## LED Lampo 3

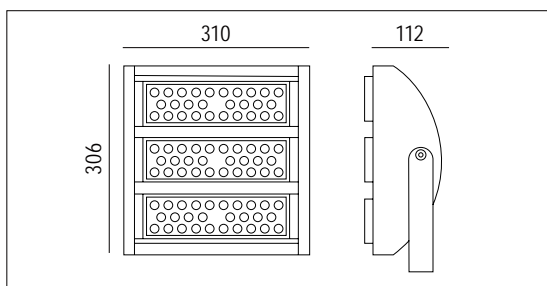

colour	W	angle	K	nominal lm tc = 25°C	lm output	lm/W	pcs	Kg	CELL
G	180	25°	4000	36.600	32.400	180	1	3,60	RFL180254K
G	180	40°	4000	36.600	32.400	180	1	3,60	RFL180404K
	G	180	40°	4000	36.600	32.400	180	3,60	RFL180404KDA
G	180	60°	4000	36.600	32.400	180	1	3,60	RFL180604K
G	180	60°	3000	36.600	32.400	180	1	3,60	RFL180603K
G	180	ASY	4000	36.600	32.400	180	1	3,60	RFL180ASY4K

Floodlight

## LED Lampo 4

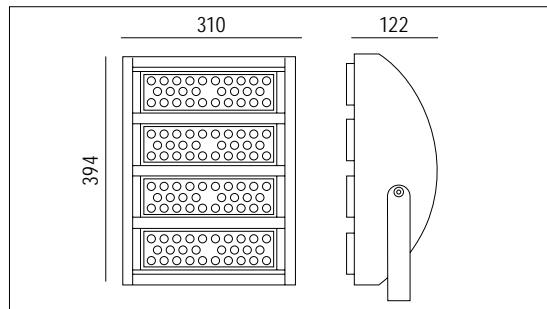

colour	W	angle	K	nominal lm tc = 25°C	lm output	lm/W	pcs	Kg	CELL
G	240	25°	4000	48.800	43.200	180	1	5,40	RFL240254K
G	240	40°	4000	48.800	43.200	180	1	5,40	RFL240404K
G	240	60°	4000	48.800	43.200	180	1	5,40	RFL240604K
G	240	60°	3000	48.800	43.200	180	1	5,40	RFL240603K
G	240	ASY	4000	48.800	43.200	180	1	5,40	RFL240ASY4K

## LED Lampo 6

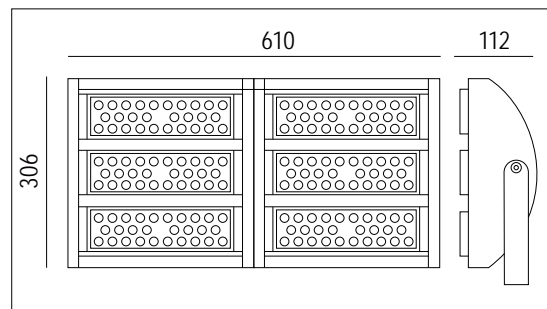
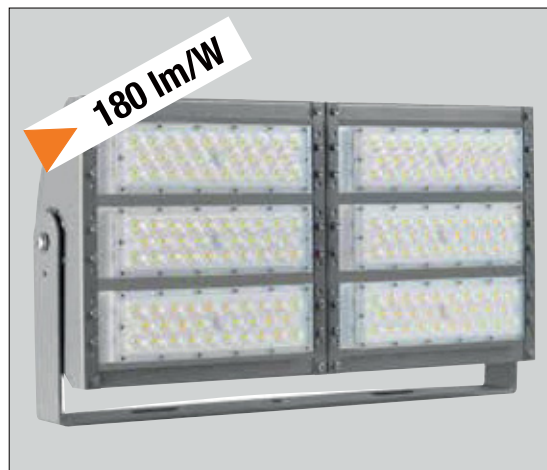

colour	W	angle	K	nominal lm tc = 25°C	lm output	lm/W	pcs	Kg	CELL
G	240	10°	4000	48.800	43.200	180	1	7,50	RFL350104K
G	350	25°	4000	71.200	63.000	180	1	7,50	RFL350254K
G	350	40°	4000	71.200	63.000	180	1	7,50	RFL350404K
<b>DALI 2</b> G	350	40°	4000	71.200	63.000	180	1	7,50	RFL350404KDA
G	350	60°	4000	71.200	63.000	180	1	7,50	RFL350604K
G	350	ASY	4000	71.200	63.000	180	1	7,50	RFL350ASY4K
<b>DALI 2</b> G	350	ASY	4000	71.200	63.000	180	1	7,50	RFL350ASY4KDA

# LED Lampo 10



colour	W	angle	K	nominal Im tc = 25°C	Im output	lm/W	pcs	Kg	CELL
<b>G</b>	400	10°	4000	81.300	72.000	180	1	16,00	RFL500104K
<b>G</b>	500	25°	4000	101.700	90.000	180	1	16,00	RFL500254K
<b>G</b>	500	40°	4000	101.700	90.000	180	1	16,00	RFL500404K
<b>DALI 2</b> <b>G</b>	500	40°	4000	101.700	90.000	180	1	16,00	RFL500404KDA
<b>G</b>	500	60°	4000	101.700	90.000	180	1	16,00	RFL500604K
<b>G</b>	500	60°	5000	101.700	90.000	180	1	16,00	RFL500605K
<b>DALI 2</b> <b>G</b>	500	60°	4000	101.700	90.000	180	1	16,00	RFL500604KDA
<b>G</b>	500	ASY	4000	101.700	90.000	180	1	16,00	RFL500ASY4K

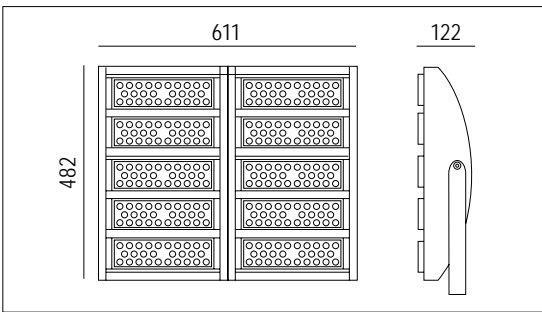

# LED Lampo 12



colour	W	angle	K	nominal Im tc = 25°C	Im output	lm/W	pcs	Kg	CELL
<b>G</b>	480	10°	4000	93.300	82.600	180	1	20,00	RFL700104K
<b>G</b>	700	25°	4000	142.400	126.000	180	1	20,00	RFL700254K
<b>G</b>	700	40°	4000	142.400	126.000	180	1	20,00	RFL700404K
<b>G</b>	700	60°	4000	142.400	126.000	180	1	20,00	RFL700604K
<b>G</b>	700	ASY	4000	142.400	126.000	180	1	20,00	RFL700ASY4K
<b>G</b>	700	ASY	3000	142.400	126.000	180	1	20,00	RFL700ASY3K

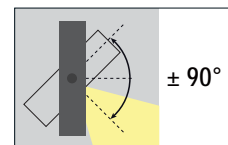
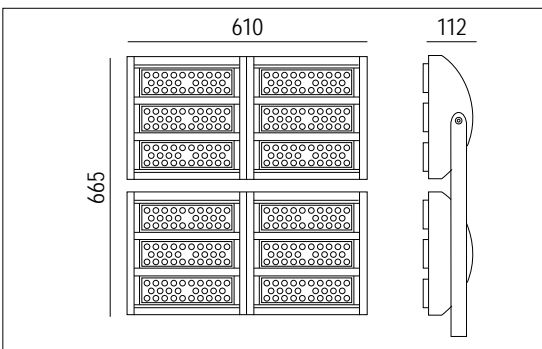

Rotazione gruppo ottiche  $\pm 90^\circ$   
(ogni gruppo è indipendente)  
Optical group rotation  $\pm 90^\circ$   
(each group is independent)

# LED Lampo 18



colour	W	angle	K	nominal lm tc = 25°C	lm output	lm/W	pcs	Kg	CELL
G	800	10°	4000	162.700	144.000	180	1	30,00	RFL1000104K
G	1000	25°	4000	203.400	180.000	180	1	30,00	RFL1000254K
G	1000	40°	4000	203.400	180.000	180	1	30,00	RFL1000404K
G	1000	60°	4000	203.400	180.000	180	1	30,00	RFL1000604K
G	1000	ASY	4000	203.400	180.000	180	1	30,00	RFL1000ASY4K

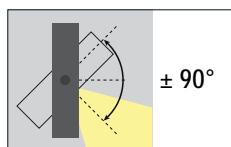
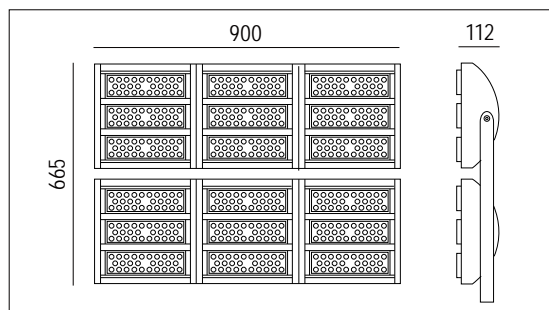

Rotazione gruppo ottiche  $\pm 90^\circ$   
(ogni gruppo è indipendente)  
Optical group rotation  $\pm 90^\circ$   
(each group is independent)

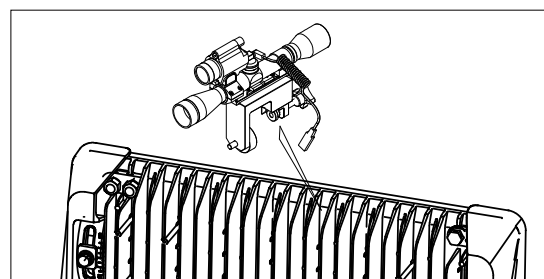

Accessorio puntatore laser  
Laser point accessory



### Luce solo all'occorrenza - *Light only when needed*



Cod. ES-M08A

Rilevatore di movimento a microonde con crepuscolare e stand-by regolabile, aggiungere Y dopo il codice  
Per maggiori informazioni vedi Pag. 636

*Microwave motion detector with crepuscular and dimmable stand-by, add Y after the code,  
For more information see Page 636*

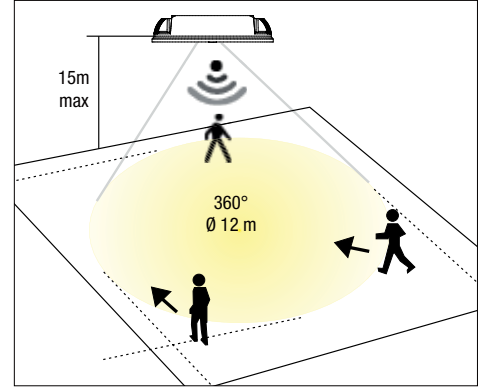

### Dettagli - *Details*

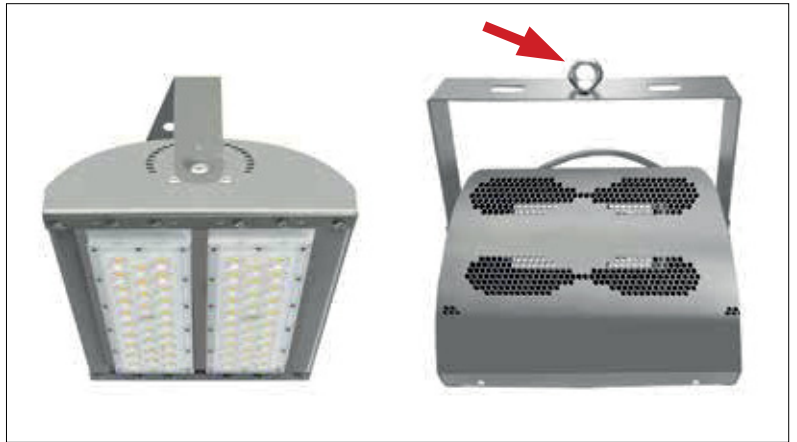

Cod. GFR100.000

Gancio per applicazione a sospensione  
*Hook for suspension application*



# LED Lampo serie



Cod. 703952.NEW

Attacco palo per l'installazione di 1 proiettore, Ø 60/76 mm. In ferro verniciato con polveri termoindurenti poliesteri resistenti alla corrosione ed agli agenti atmosferici.

*Pole attachment for the installation of 1 projector, size Ø 60/76 mm. Iron coated with polyester thermosetting powder coating, offering high resistance to rust and external atmospheric agents.*



Cod. CARTER1 (LED Lampo 120W)

Cod. CARTER2 (LED Lampo 180W)

Cod. CARTER3 (LED Lampo 240W)

Cod. CARTER4 (LED Lampo 350W - 2 moduli per LED Lampo 700W)

Cod. CARTER5 (LED Lampo 500W)

CARTER per un'ulteriore protezione

*CARTER for enhanced protection and design*

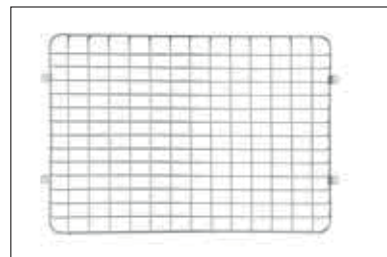

Cod. RETE140 (LED Lampo 120W)

Cod. RETE180 (LED Lampo 180W)

Cod. RETE240 (LED Lampo 240W)

Griglia di protezione - *Protection grid*

## Ottiche di serie - Standard optics

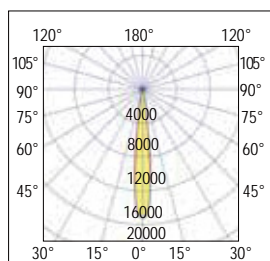

10°  
Super spot

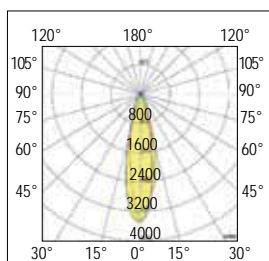

25°  
Concentrate - Spot

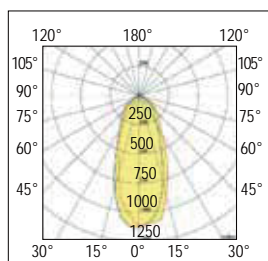

40°  
Semi-diffondente - Wide

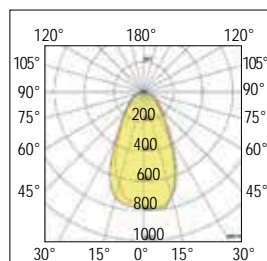

60°  
Diffondente - Flood

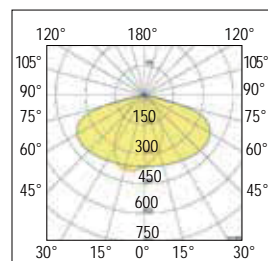

ASY  
Asimmetrico - Asymmetric

## Applicazioni - Applications

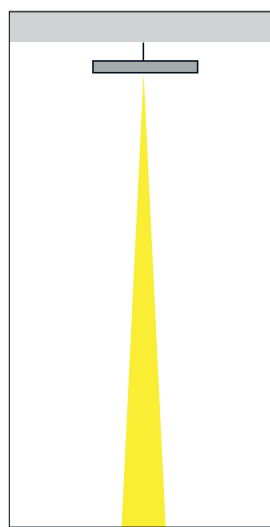

10°  
Super spot

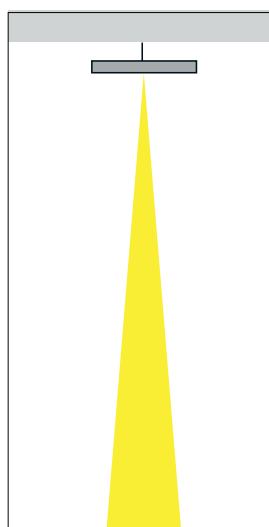

25°  
Concentrate - Spot

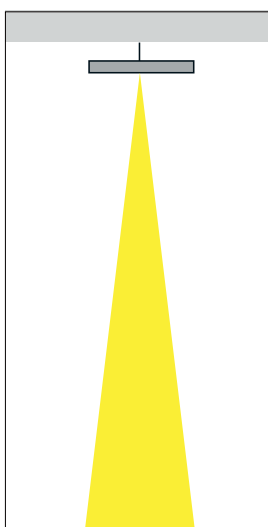

40°  
Semi-diffondente - Wide

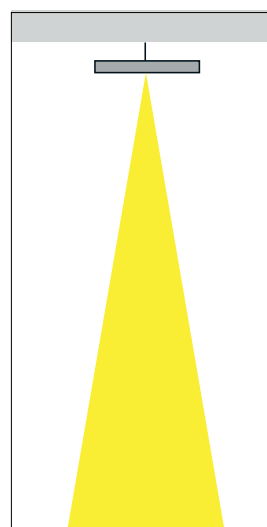

60°  
Diffondente - Flood

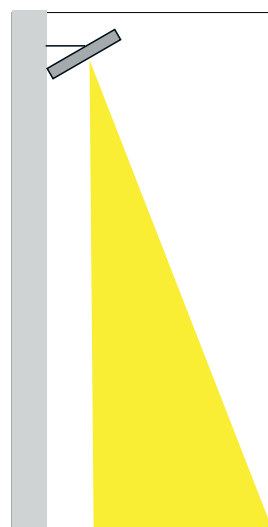

ASY  
Asimmetrico - Asymmetric

I lm/W della serie LED Lampo sono stati certificati da istituto esterno

The lm/W of the LED Lampo series have been certified by an external institute

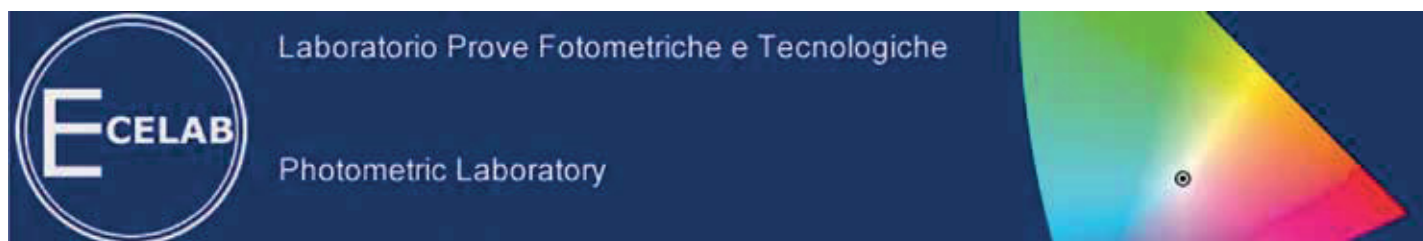

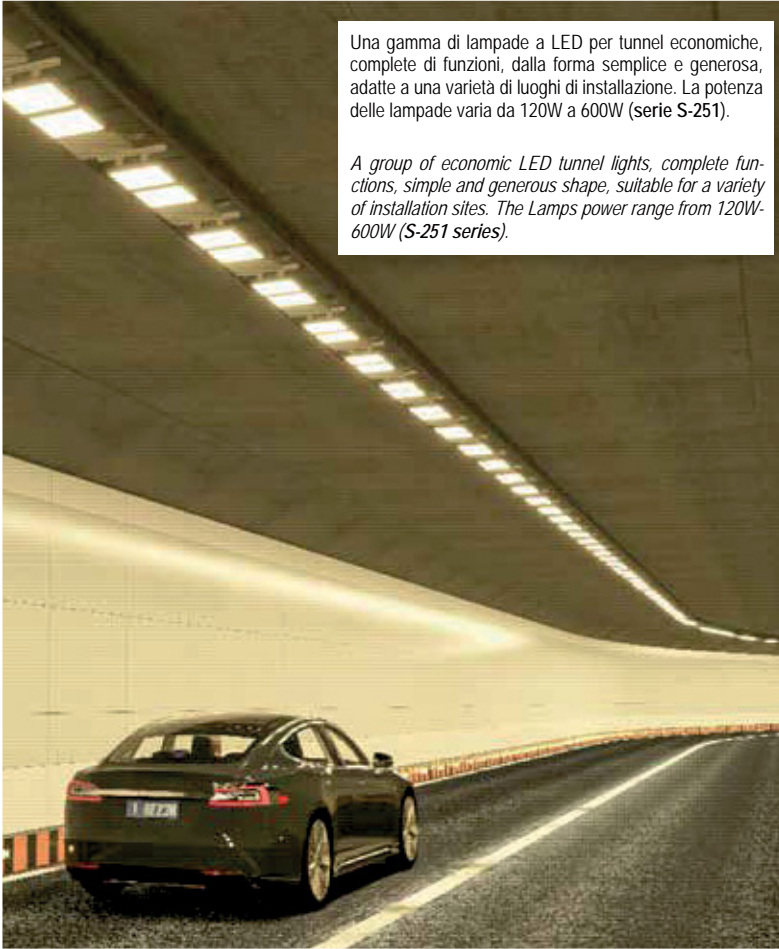

Una gamma di lampade a LED per tunnel economiche, complete di funzioni, dalla forma semplice e generosa, adatte a una varietà di luoghi di installazione. La potenza delle lampade varia da 120W a 600W (serie S-251).

*A group of economic LED tunnel lights, complete functions, simple and generous shape, suitable for a variety of installation sites. The Lamps power range from 120W-600W (S-251 series).*

## Serie S-251



S-251-1M  
120-150W



S-251-2M  
200-240-300W

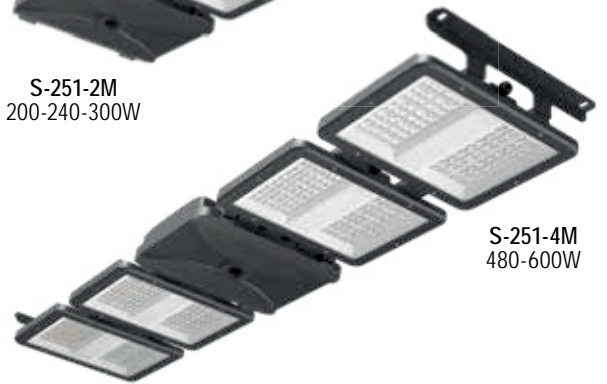

S-251-4M  
480-600W

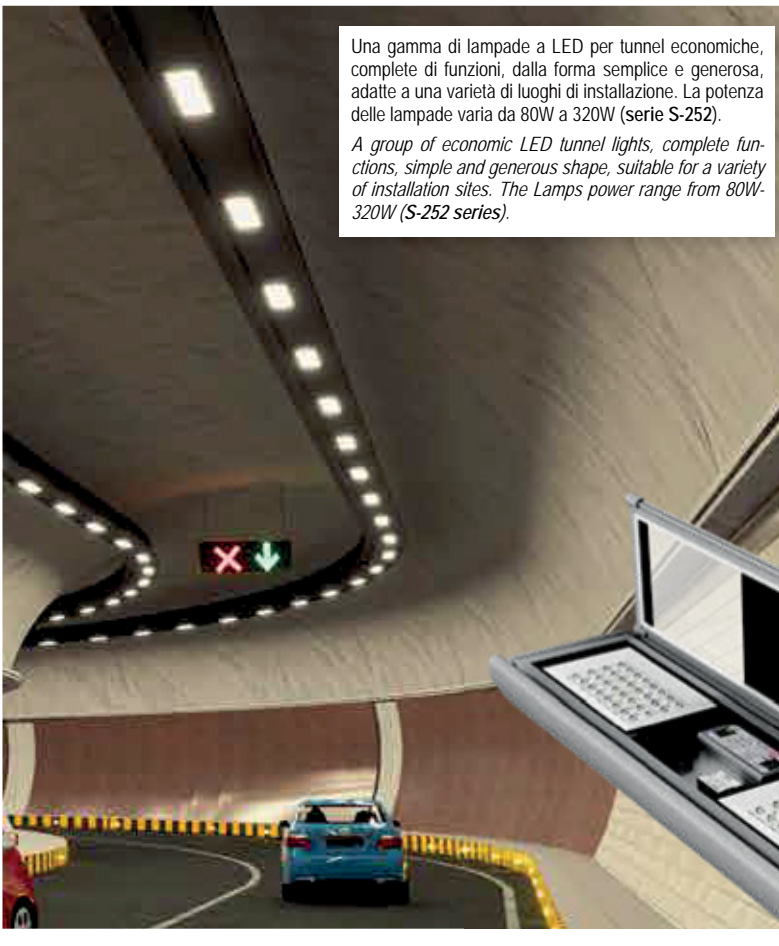

Una gamma di lampade a LED per tunnel economiche, complete di funzioni, dalla forma semplice e generosa, adatte a una varietà di luoghi di installazione. La potenza delle lampade varia da 80W a 320W (serie S-252).

*A group of economic LED tunnel lights, complete functions, simple and generous shape, suitable for a variety of installation sites. The Lamps power range from 80W-320W (S-252 series).*

## Serie S-252



S-252S  
80-120W



S-252M  
180-240W

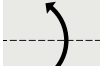

## S-251-1M

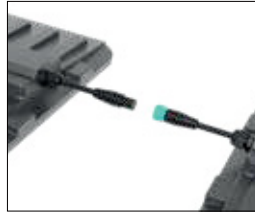
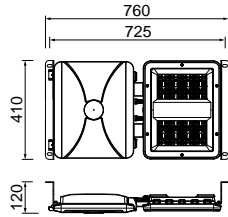

Tutti i connettori sono progettati con spine impermeabili per una connessione rapida e semplice.

All connectors are designed with waterproof plugs for quick and easy connection.

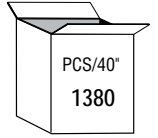

colour	LED Type	LED Q.ty	W	Optic	K	lm output	lm/W	pcs	Kg	CELL	Euro cad./each
G	LED CHIPS 3535/5050	64	120	T1 / T2A / T3A / T4A	4000	20.400	170	1	14,5	S251LED1204K	585,00
G	LED CHIPS 3535/5050	96	150	T1D / T2D / T3D / T4D	4000	25.500	170	1	14,5	S251LED1504K	585,00

## S-251-2M

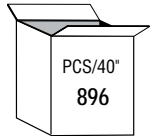
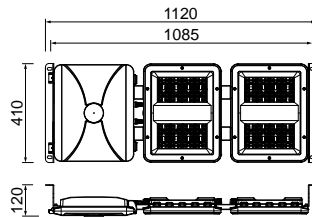

colour	LED Type	LED Q.ty	W	Optic	K	lm output	lm/W	pcs	Kg	CELL	Euro cad./each
G	LED CHIPS 3535/5050	128	200	T1 / T2A / T3A / T4A	4000	34.400	170	1	19,5	S251LED2004K	920,00
G	LED CHIPS 3535/5050	128	240	T1D / T2D / T3D / T4D	4000	51.500	170	1	19,5	S251LED2404K	940,00
G	LED CHIPS 3535/5050	128	300	T1D / T2D / T3D / T4D	4000	51.500	170	1	19,5	S251LED3004K	940,00

## S-251-4M

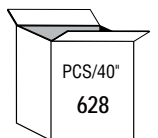
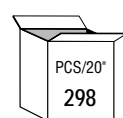
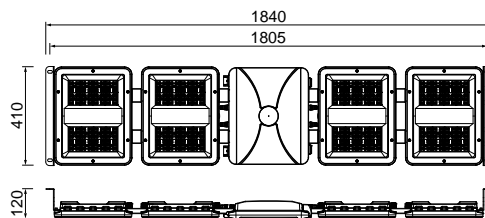

colour	LED Type	LED Q.ty	W	Optic	K	lm output	lm/W	pcs	Kg	CELL	Euro cad./each
G	LED CHIPS 3535/5050	256	480	T1 / T2A / T3A / T4A	4000	81.600	170	1	19,5	S251LED4804K	1.700,00
G	LED CHIPS 3535/5050	384	600	T1D / T2D / T3D / T4D	4000	102.500	170	1	19,5	S251LED6004K	1.700,00

### Distribuzione della luce - Light distribution

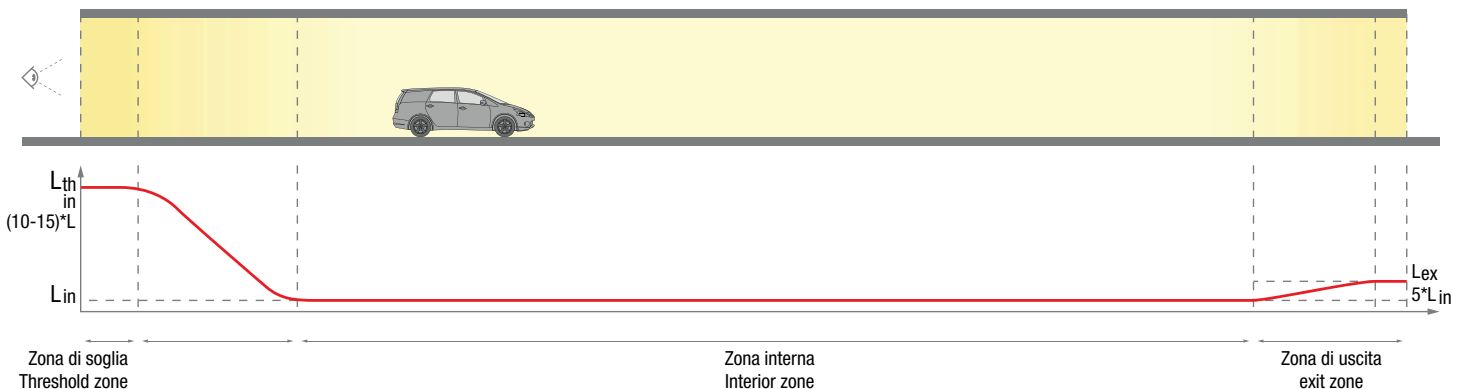

## Ottiche - Optics application

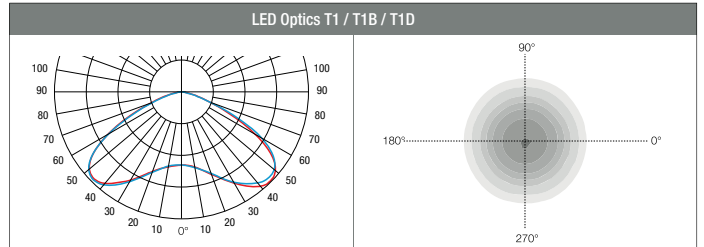
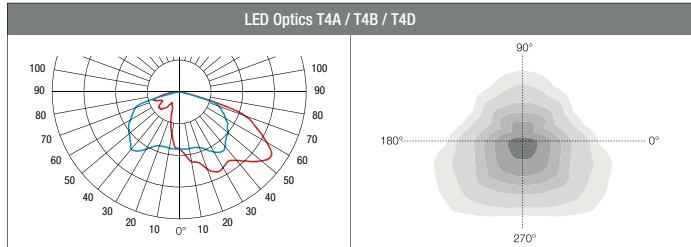
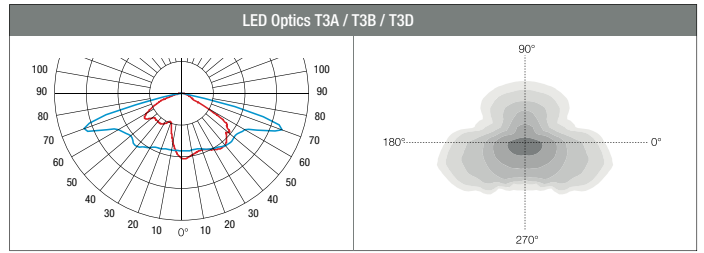
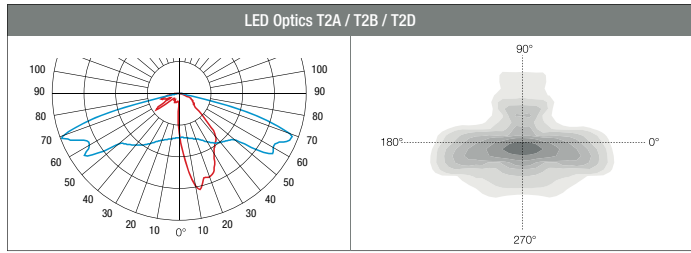

## Modalità di illuminazione - Lighting mode

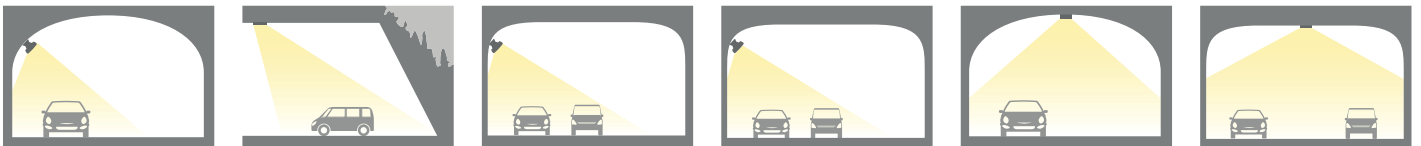

## Altre possibilità di installazione - Other installation methods

Applicazioni: tunnel, officine, magazzini, sale espositive, ecc.

Applications: Tunnel, workshop, warehouse, exhibition hall, etc

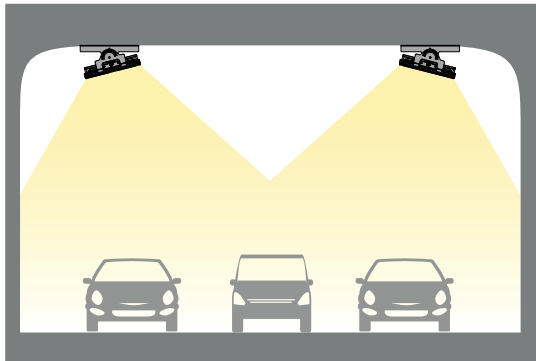

Montaggio a plafone, angolo regolabile  
Top mount, adjustable Angle

Accessorio non incluso- Not included accessory

Descrizione/Description	Codice/Code
 Staffa a plafone regolabile Adjustable ceiling bracket	S251STAFCE

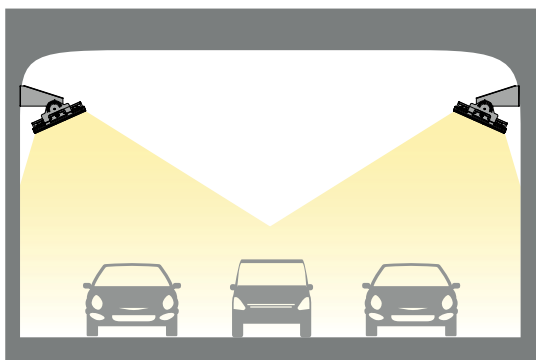

Montaggio a parete, angolo regolabile  
Wall mount, adjustable angle

Accessorio non incluso- Not included accessory

Descrizione/Description	Codice/Code
 Staffa angolare regolabile a parete Adjustable wall angle bracket	S251STAFWALL



## S-252S

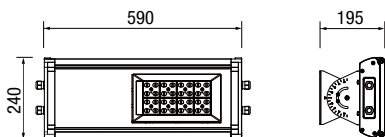

Tutti i connettori sono progettati con spine impermeabili per una connessione rapida e semplice.

All connectors are designed with waterproof plugs for quick and easy connection.

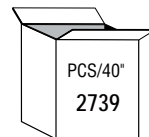
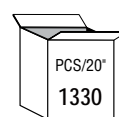

colour	LED Type	LED Q.ty	W	Optic	K	lm output	lm/W	pcs	Kg	CELL	Euro cad./each
G	LED CHIPS 3535/5050	48	80	T1/T2A/T3A/T4A	4000	12.000	150	1	7,2	S252SLED804K	480,00
G	LED CHIPS 3535/5050	48	100	T1D/T2D/T3D/T4D	4000	18.000	150	1	7,2	S252SLED1004K	475,00

## S-252M

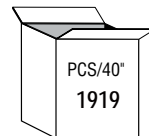
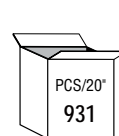
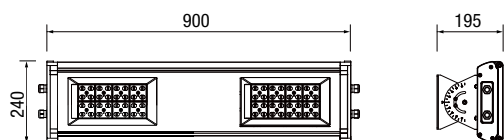

colour	LED Type	LED Q.ty	W	Optic	K	lm output	lm/W	pcs	Kg	CELL	Euro cad./each
G	LED CHIPS 3535/5050	64	150	T1/T2A/T3A/T4A	4000	22.500	150	1	10,5	S252MLED1504K	700,00
G	LED CHIPS 3535/5050	96	200	T1D/T2D/T3D/T4D	4000	30.000	150	1	10,5	S252MLED2004K	725,00
G	LED CHIPS 3535/5050	96	240	T1D/T2D/T3D/T4D	4000	36.000	150	1	10,5	S252MLED2404K	740,00

Floodlight

L'angolo può essere regolato da -90 a +90 gradi per ottenere l'angolo ottico ottimale.

The Angle can be adjusted from -90 to +90 degrees to achieve the best optical angle.

### Accessori non inclusi - Not included accessories

	Descrizione/Description	Codice/Code
	Staffa per montaggio a plafone Ceiling mounting bracket	S252STAFCE
	Staffa regolabile superiore Adjustable upper bracket	S252STAFCEUP
	Staffa regolabile a soffitto Adjustable ceiling bracket	S252STAFCEDO
	Staffa angolare regolabile a parete Wall mounted adjustable Angle bracket	S252STAFWALL



## Ottiche - Optics application

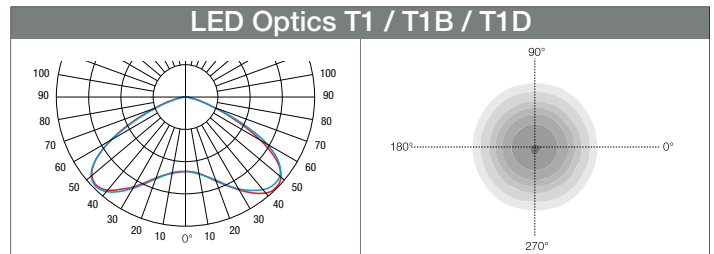
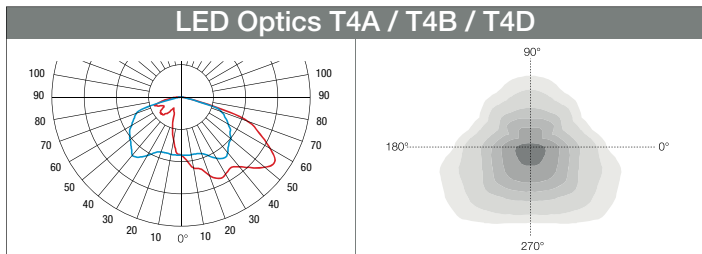
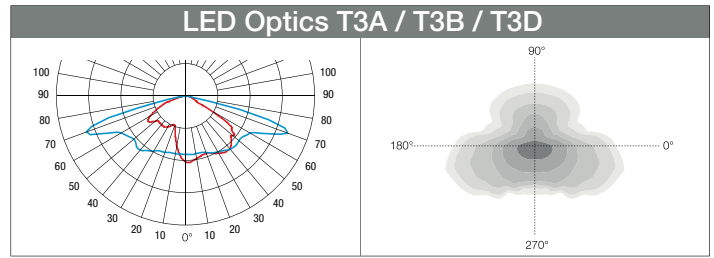
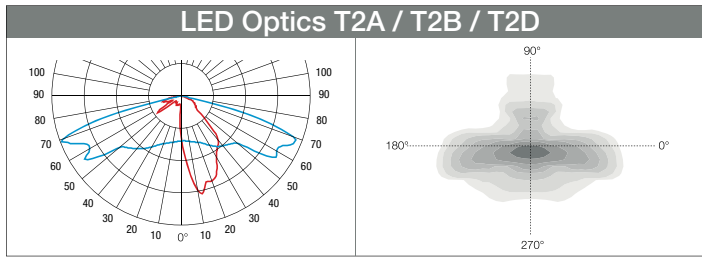

### Descrizione - Description:

- Il corpo della lampada è realizzato in alluminio pressofuso ad alta resistenza, dalla struttura semplice e robusta.
  - Prestazioni del prodotto stabili, durevoli e affidabili; un ambiente di installazione in grado di resistere efficacemente alle vibrazioni a lungo termine.
  - Vetro temperato ultra-bianco per un elevato comfort visivo e una distribuzione uniforme della luce.
  - Con una varietà di specifiche da 80W a 320W, può soddisfare i requisiti di installazione di diversi ambienti.
  - La lampada adotta tre tipi di montaggio fisso con staffa posteriore, con angolazione regolabile.
  - Nessun rischio fotobiologico (nessun rischio legato a infrarossi, luce blu e radiazioni UV) in conformità con la norma EN 62471:2008.
  - Controllo dell'illuminazione stradale tramite tecnologia di controllo intelligente.
- Compatibile con il sistema di gestione remota.
- Tutte le viti esterne sono realizzate in acciaio inossidabile 304.

- The lamp body is made of high strength die-cast aluminum, simple structure and high strength.
- Product performance is stable, durable and reliable; An installation environment that can effectively resist long-term vibration.
- Ultra-white tempered glass for high visual comfort and uniform light distribution.
- With a variety of specifications from 80W to 320W, it can meet the installation requirements of different environments.
- The lamp adopts three kinds of back bracket fixed installation, the angle is adjustable.
- No photo-biological risk, (no risk linked to infrared, blue light and UV radiation) in accordance with EN 62471:2008.
- Street lighting control used with smart control technology. It can be compatible with remote management system.
- All external screws are made of 304 stainless steel.

**Applicazioni: tunnel, officine, magazzini, sale espositive, ecc.**

**Applications: Tunnel, workshop, warehouse, exhibition hall, etc.**

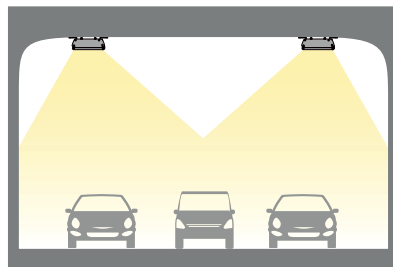

Montaggio a plafone  
ceiling mount

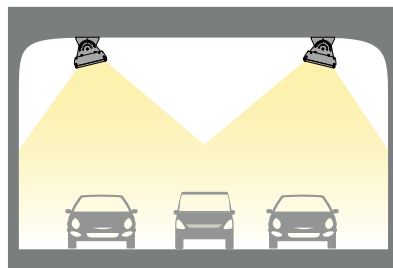

Montaggio a plafone, angolo regolabile  
ceiling mount adjustable angle

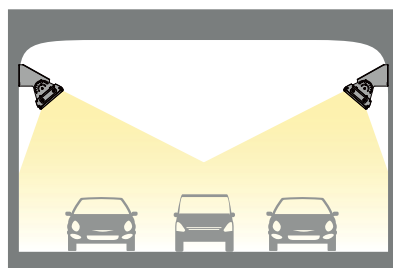

Montaggio a parete, angolo regolabile  
wall mounting adjustable angle





# LED Minizeus - LED Zeus



A richiesta: versione conforme alla direttiva HACCP per gli impianti illuminotecnici nelle industrie alimentari

*On demand: HACCP directive for lighting systems in food industries version*

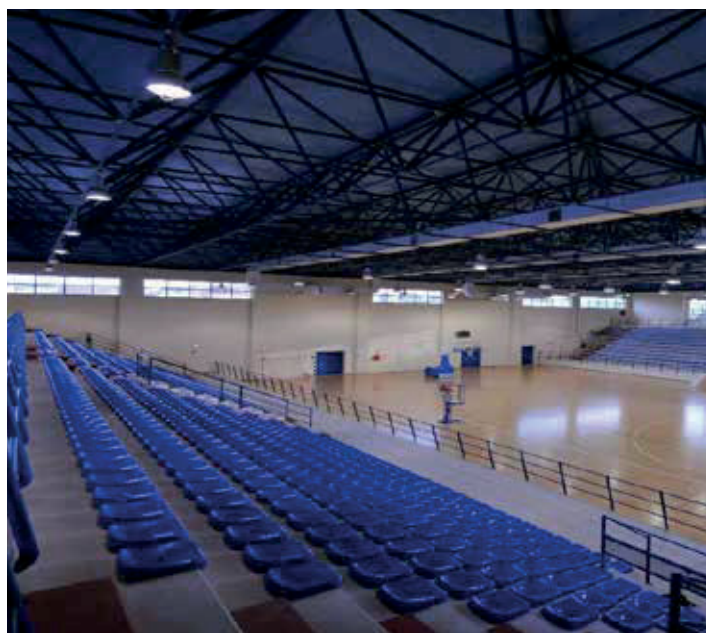

Floodlight



LED Minizeus: Accessori non inclusi - *Not included accessories*

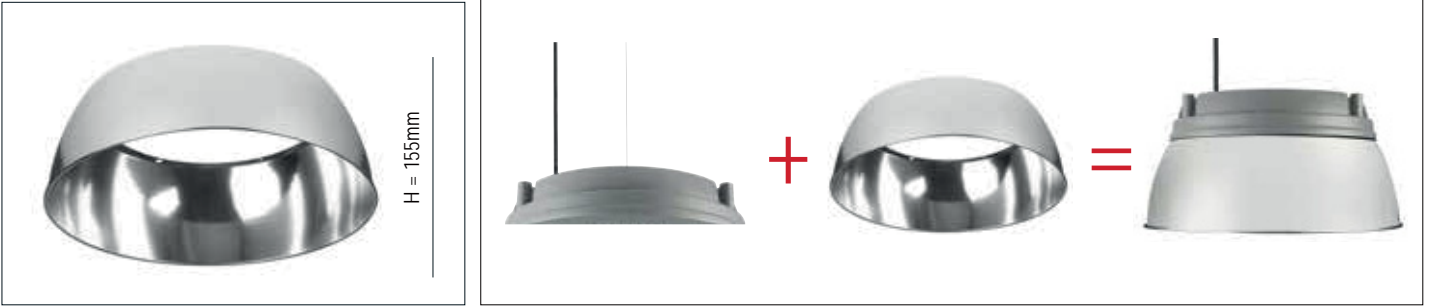

Cod: RF-60100  
Riflettore in alluminio compreso di 4 viti 51804500 - *Aluminum reflector including 4 screws 51804500*



Floodlight

# LED Zeus

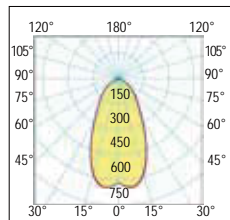
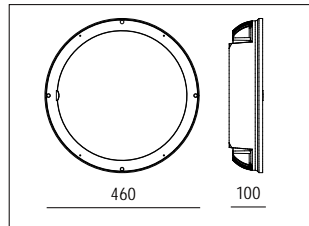

50° - Intermedio - Medium

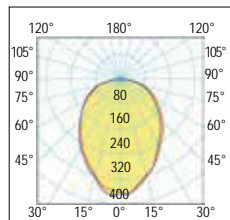

90° - Diffondente - Wide

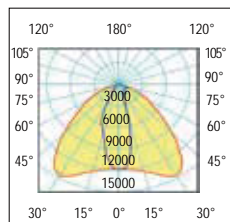

ELLIP  
Ellittica - Elliptical

DALI 2

DALI 2

colour	W	angle	K	nominal lm tc = 25°C	lm output	lm/W	pcs	Kg	CELL
G	175	50°	4000	28.670	25.375	145	1	9,70	334087.185
G	175	90°	4000	28.670	25.375	145	1	9,70	334096.185
G	200	50°	4000	32.770	29.000	145	1	9,70	HE4087.210
G	250	50°	4000	40.900	36.250	145	1	9,70	HE4087.250
G	200	90°	4000	32.770	29.000	145	1	9,70	HE4096.210
G	250	90°	4000	40.900	36.250	145	1	9,70	HE4096.250
G	210	50°	4000	34.400	30.450	145	1	9,70	334087.210D
G	210	90°	4000	34.400	30.450	145	1	9,70	334096.210D

DALI 2

colour	W	angle	K	nominal lm tc = 25°C	lm output	lm/W	pcs	Kg	CELL
G	175	ELLIP	4000	28.670	25.375	145	1	9,70	334029.185E
G	200	ELLIP	4000	32.770	29.000	145	1	9,70	HE4029.210E
G	210	ELLIP	4000	34.400	30.450	145	1	9,70	334029210ED



LED Minizeus e LED Zeus vengono forniti completi di gancio per applicazione a sospensione

LED Minizeus e LED Zeus comes complete with hook for application to suspension



Dispositivo anticondensa: valvola di compensazione e riciclo dell'aria.

Anti-condensate device: valve for compensation and circulation of air.



Completo di connettore IP68 per una rapida installazione

Complete with IP68 connector for quick installation

# LED Zeus - LED Minizeus

LED Minizeus - LED Zeus: Accessori non inclusi - *Not included accessories*

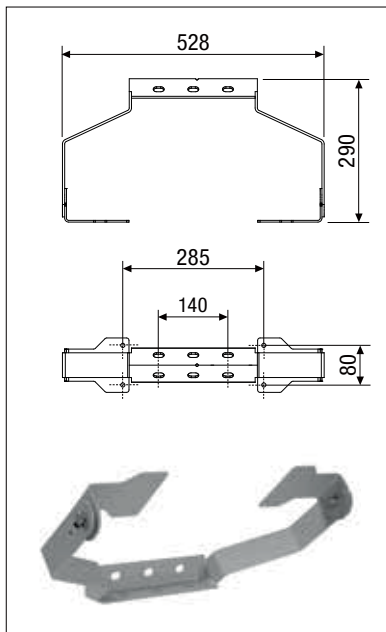

Code: 703959.0101

Staffa sagomata orientabile per montaggio a parete più goniometro per puntamento proiettore  
*Shaped adjustable bracket for wall mounting complete with protractor pointing to the projector*

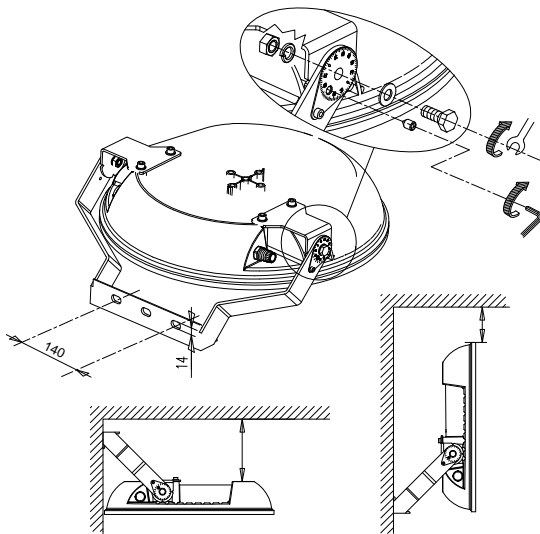

Code: 2020.001

Staffa orientabile per montaggio a parete  
*Shaped bracket for wall mounting*



Code: CA1000.018

Catena per installazione a sospensione - Lunghezza 1m  
*Chain for suspension installation - Length 1m*

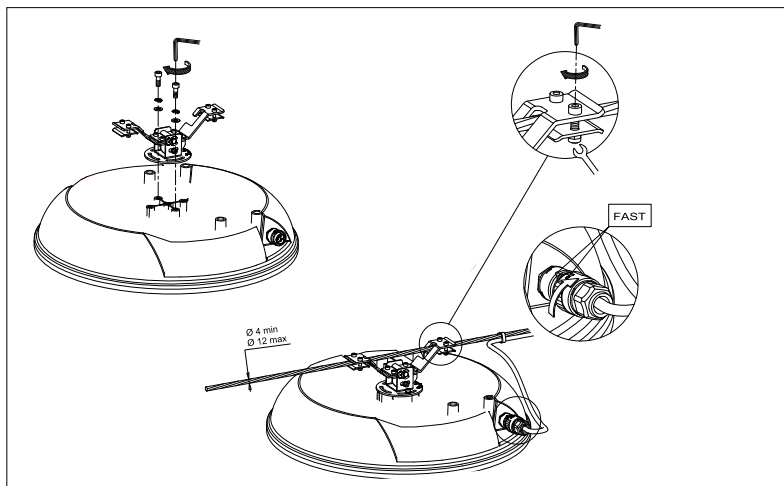

Code: 703960.0101 - Staffa a tesata - *Suspension mounting*



Cod: 703952.NEW

Attacco palo per 1 o 2 proiettori, Ø 60/76mm  
*Pole attachment for either 1 or 2 floodlights, size Ø 60/76mm*

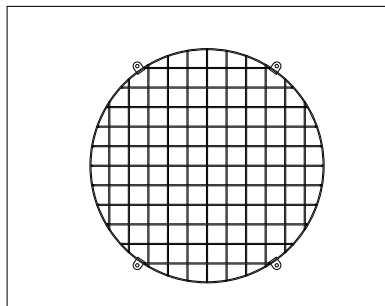

Cod: 800017.0101 - LED Minizeus  
Griglia di protezione - *Protection grid*

Cod: 800016.0101 - LED Zeus  
Griglia di protezione - *Protection grid*

Code: RO0640/N

## PROTEZIONE ALLE SOVRATENSIONI (di serie in LED Zeus) SURGE PROTECTOR (of serie in LED zeus)

In un impianto elettrico standard un apparecchio a LED può essere sottoposto a sbalzi di tensione e disturbi esterni dovuti a fattori quali carichi discontinui sulla linea, guasti sulle linee a monte o a valle e, soprattutto, scariche atmosferiche (negli impianti esterni). Nei nostri proiettori, dove l'elettronica è fondamentale, la resistenza alle sovratensioni è sinonimo di affidabilità e corretta funzionalità.

*In a standard electrical system an LED luminaire can be subjected to voltage fluctuations and external disturbances due to factors such as discontinuous loads on the line, faults on the lines upstream or downstream and, especially, atmospheric discharges (in External Plants). In our projectors, where electronics is very important, the surge resistance is synonymous with reliability and proper functionality.*



Dispositivo di protezione conforme alla Norma EN 61547 contro i fenomeni impulsivi atto a proteggere il modulo LED e il relativo alimentatore: classe II fino a 10kV

*Protection device in compliance with the EN 61547 standard to counteract the impulsive phenomena designed to protect the LED module and the relative power supply: class II protection up to 10kV*

## Sovratensioni

Le sovratensioni sono un rapido innalzamento della differenza di potenziale tra le diverse polarità (Fase o Neutro) e la Terra, in alcuni casi sono talmente elevate da superare la soglia di isolamento dei componenti elettronici causandone così il danneggiamento. Esistono anche casi di sovratensioni di entità inferiore, le quali non provocano un immediato guasto dei moduli LED o driver privi di protezione, ma se nel tempo si verificano ripetutamente possono provocare il deterioramento dei LED, di conseguenza, una durata ridotta. Nel caso di sovratensioni di elevata entità, come la caduta dei fulmini, provocano invece un guasto immediato dei moduli LED o dei driver. Le sovratensioni, di fatto, provocano degli impulsi di energia con correnti elevate sia nel driver che nei moduli LED.

## Overvoltages

*Overvoltages are a rapid rise in the potential difference between the different polarities (Phase or Neutral) and the Earth, in some cases they are so high as to exceed the isolation threshold of the electronic components, thus causing damage. There are also cases of minor overvoltages, which do not cause an immediate failure of the unprotected LED modules or drivers, but if they occur repeatedly over time they can cause deterioration of the LEDs, consequently a reduced life span. In the event of high voltage surges, such as lightning strikes, they cause immediate failure of the LED modules or drivers. The overvoltages, in fact, cause energy pulses with high currents in both the driver and the LED modules.*

**A richiesta:** verniciatura resistente a 2.000 ore di esposizione alla nebbia salina in accordo alla norma ISO 9227 certificato da Ente esterno.



**On request:** painting resistant to 2,000 hours of exposure to salt spray in accordance with ISO 9227 certified by an external body.

# LED Minizeus - LED Zeus

Soluzioni NON incluse per aumentare il risparmio energetico - NOT included solutions to increase energy saving

## Sensor - Sensor

### Luce solo all'occorrenza - Light only when needed

Rilevatore di movimento a microonde con crepuscolare per impostazione soglia minima Lux ambiente di intervento e con livello di stand-by impostabile (10-20-30%) con driver dimmerabili [0-10V]; questa tecnologia emette onde elettromagnetiche ad alta frequenza (5,8GHz) e riceve il loro eco, in questo modo è in grado di riconoscere una qualsiasi variazione data da un oggetto non rilevato nella precedente analisi e verrà dato il comando di ON. La trasmissione ad alta frequenza è <10mW e risulta essere 100 volte inferiore alle emissioni di un comune telefono cellulare o di un forno a microonde che emettono mediamente 1000mW.

Microwave motion detector with twilight with adjustable stand-by level for setting Lux threshold for the intervention environment and with settable stand-by level (10-20-30%) with dimmable [0-10V] driver; this technology emits electromagnetic waves at a high frequency (5.8GHz) and receives their echoes. In this way, it can recognise any variation given by an object not detected in the previous analysis and the ON command will be given. High frequency transmission is <10mW and is 100 times lower than the emissions of a common mobile phone or a microwave oven emitting an average of 1000mW.



Esempio applicativo  
Installazione su corpo illuminante  
Application example  
Installation on lighting body



Rilevatore di movimento a microonde con crepuscolare e stand-by regolabile, aggiungere Y dopo il codice + Euro 80,00 al prezzo di listino

Microwave motion detector with crepuscular and dimmable stand-by, add Y after the code + Euro 80.00 to the list price

Specifiche tecniche - Technical specification	
Tensione di rete - Power supply	220-240Vac - 50/60Hz
Potenza - Power	1000W - 500VA
Frequenza - Frequency	5,8GHz
Angolo di rilevamento - Detection angle	360°
Velocità di rilevamento movimento Motion detection speed	0,5-3m/s
Altezza di installazione - Assembly height	1÷15 m
Consumo energetico - Energy consumption	< 0,9W
Grado IP - IP degree	IP65
Tecnologia - Technology	Microonde - Microwave
Temperatura di funzionamento sensore Sensor operating temperature	-35...50°C
Tempo di spegnimento - Switch-off time	10 sec ÷ 30 min
Sensibilità lux - Lux sensitivity	5=200 lux 24h
Sensibilità - Sensitivity	12m (regolabile - reglable)
Trasmissione di segnale - Signal transmission	< 10mW
Stand-by dimming level	0%, 10%, 20%, 30%

LED Minizeus + Sensor  
Dimensioni (mm) - Dimensions (mm)

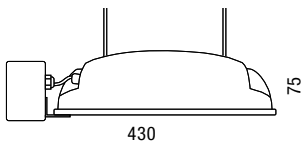

LED Zeus + Sensor  
Dimensioni (mm) - Dimensions (mm)

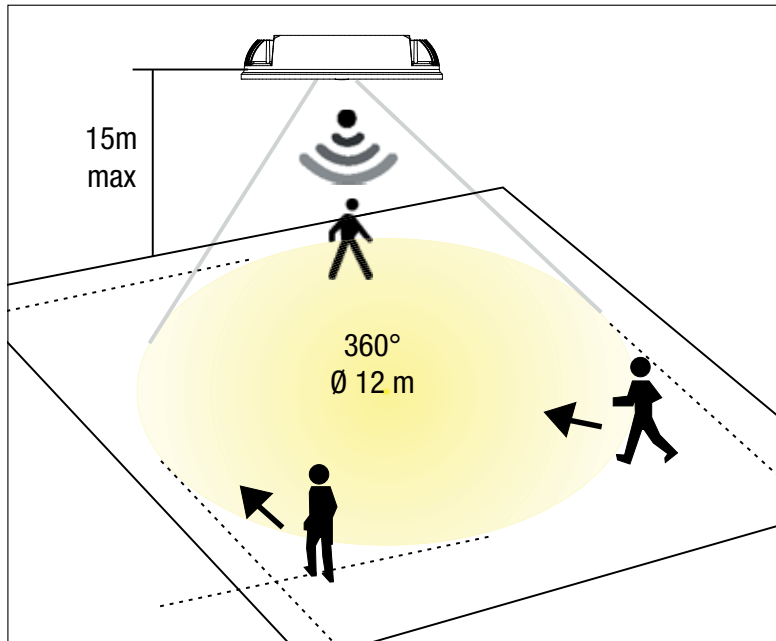
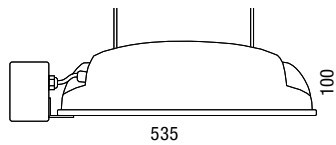

### Trasmittitore incluso - Included transmitter

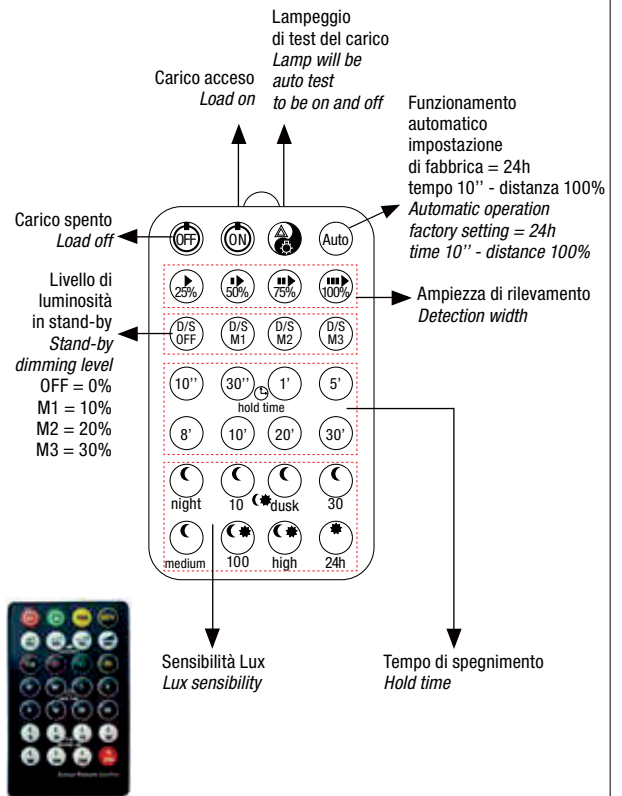

# LED Minizeus - LED Zeus

Soluzioni NON incluse per aumentare il risparmio energetico - *NOT included solutions to increase energy saving*

## DYNA Control

**Fig. 1 - Esempio applicativo 2 steps - Application example 2 steps**

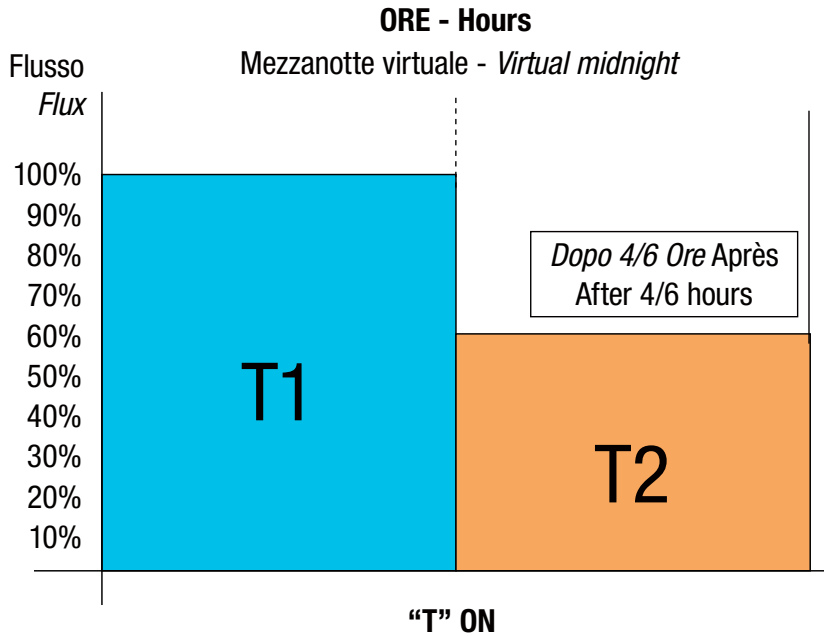

**T1 = 100% Flusso luminoso**  
**T1 = 100% Luminous flux**

**T2 = 70% Flusso luminoso**  
**T2 = 70% Luminous flux**

Minimo tempo di accensione per funzionamento automatico 4 ore (3 giorni).  
Accensioni di 1 ora ignorate.  
Accensioni da 1 a 4 ore oppure superiori alle 23 ore resettano il sistema.

*The minimum ignition time for automatic operation is 4 hours (three days).  
Ignitions 1 hour ignored.  
Switching from 1 to 4 hours or higher with 23 hours reset the system.*

DYNA CONTROL è un sistema di controllo del flusso luminoso delle lampade che si basa sul calcolo della mezzanotte virtuale. Il sistema entra in funzione alla prima accensione calcolando per 3 giorni i tempi di accensione. Il quarto giorno il sistema, in modo autonomo, calcola la mezzanotte virtuale eseguendo una regolazione del flusso e regolando la lampada come indicato sullo schema di Fig. 1. La riduzione del flusso luminoso avviene senza la necessità di alcun cavo di connessione aggiuntivo o dispositivo di comando esterno, questo sistema consente di ottenere un notevole risparmio energetico.

N.B. su richiesta è possibile eseguire la modifica delle impostazioni di fabbrica della mezzanotte virtuale adattandole alle specifiche del cliente.

*DYNA CONTROL is a control system for the luminous flux of the lamps which is based on virtual midnight calculation. The system starts running when turned on for the first time, calculating the start-up times for 3 days. On the fourth day, the system automatically calculates the virtual midnight by performing a flux adjustment and adjusting the lamp as indicated on the diagram of Fig. 1. The reduction of the luminous flux occurs without the need for any additional connection cable or external control device. This system can achieve considerable energy saving.*

*N.B. the factory settings of the virtual midnight can be modified on request, adjusting them to the customer's specifications.*

+ Euro 50,00 da listino - Aggiungere DC dopo il codice  
+ Euro 50,00 to the price list - Add DC after the code

Su richiesta - On demand

LED Minizeus e LED Zeus a richiesta possono essere forniti in versione <b>EMERGENZA</b> <i>On request, LED Minizeus and LED Zeus are can be supplied in an EMERGENCY version</i>	
<b>Batteria inclusa. Tempo di ricarica: 24h</b> <i>Included battery. Charging time: 24h</i>	
<b>Autonomy</b> 2h	<b>LED EMERGENCY KIT</b> 6W SA-SE 2h - IP67
<b>On demand</b> 3h	<b>LED EMERGENCY KIT</b> 3W SA-SE 3h - IP67



Aggiungere 2E (2h) o 3E (3h) dopo il codice - + Euro 120,00 al prezzo di listino  
Add 2E (2h) or 3E (3h) after the code - + Euro 120.00 to the list price



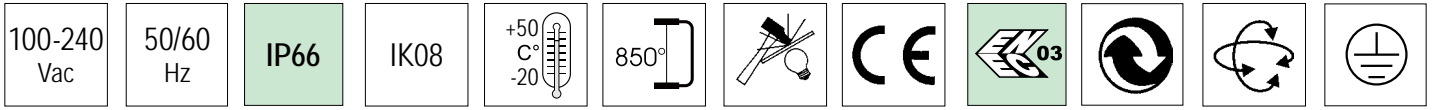

**LED Milano Logistica**

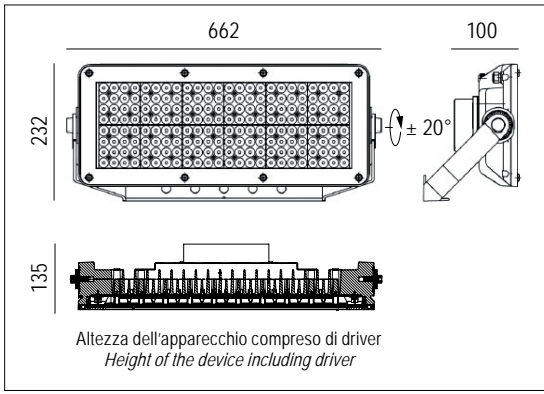

colour	W	angle	K	CRI	nominal lm tc = 25°C	lm output	lm/W	pcs	Kg	CELL
G	200	50°	4000	80	32.800	29.000	145	1	11,00	MIL20050-4K
G	200	90°	4000	80	32.800	29.000	145	1	11,00	MIL20090-4K
G	200	ELLIP	4000	80	32.800	29.000	145	1	11,00	MIL200EL-4K
G	250	50°	4000	80	40.900	36.250	145	1	11,00	MIL25050-4K
G	250	90°	4000	80	40.900	36.250	145	1	11,00	MIL25090-4K
G	250	ELLIP	4000	80	40.900	36.250	145	1	11,00	MIL250EL-4K
G	300	50°	4000	80	49.100	43.500	145	1	11,00	MIL30050-4K
G	300	90°	4000	80	49.100	43.500	145	1	11,00	MIL30090-4K
G	300	ELLIP	4000	80	49.100	43.500	145	1	11,00	MIL300EL-4K
G	400	50°	4000	80	65.500	58.000	145	1	11,00	MIL40050-4K
G	400	90°	4000	80	65.500	58.000	145	1	11,00	MIL40090-4K
G	400	ELLIP	4000	80	65.500	58.000	145	1	11,00	MIL400EL-4K

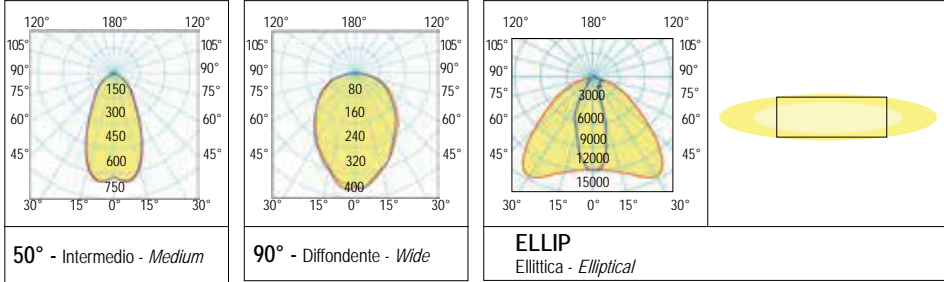

**A richiesta accessorio STAFFA DI FISSAGGIO**  
**On demand FIXING BRACKET accessory**  
Cod. STRIMISPORT



Esempio applicativo Installazione su corpo illuminante con sensore a richiesta  
*Application example Installation on lighting body with sensor on demand*

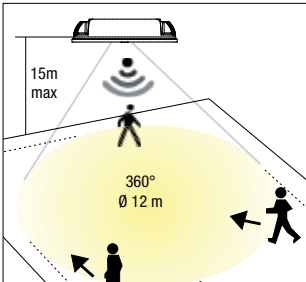
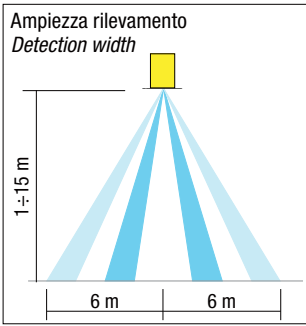
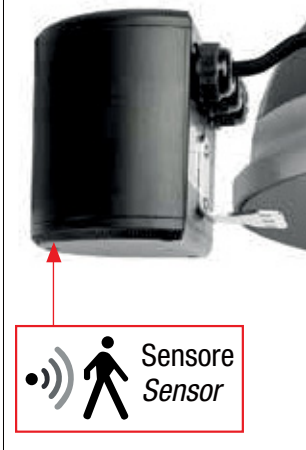

**LED Milano Logistica a richiesta può essere fornito in versione EMERGENZA 2h 6W o 3h 3W**  
*On request, LED Milano Logistica are can be supplied in an EMERGENCY version*



Floodlight

# BASIC series LED Punto Highbay 250W



LED Punto Highbay è un apparecchio progettato per fornire un'illuminazione uniforme e senza interruzioni per applicazioni industriali ed è una soluzione ideale per altezze di montaggio più elevate, applicazioni ad alta temperatura e industria pesante speciale.

**Colore** nero RAL 9004.

**Ottica:** diffondente

**Schermo:** in policarbonato resistente agli shock termici e agli urti.

**Sorgente LED SMD:** incorporato con temperatura di colore 4000K; altre temperature di colore a richiesta.

**Driver:** incorporato fattore di potenza:  $\geq 0,9$

*Punto Highbay Led is a luminaire designed to provide uninterrupted and uniform lighting for industrial application and is an ideal solution for higher mounting heights, high temperature applications and special heavy-duty industry.*

*RAL 9004 black color.*

**Optic:** diffused

**Shield:** in polycarbonate resistant to thermal shocks and collisions

**Light source SMD LED:** included with color temperature 4000K; other color temperatures available on demand.

**Driver:** included Power factor:  $\geq 0,9$

## Installation - Installation

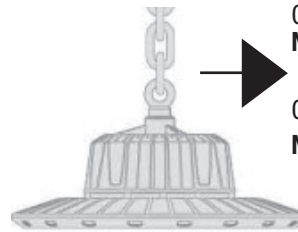

Catena per applicazione in sospensione  
**NON INCLUSO**

Chain for suspension application  
**NOT INCLUDED**

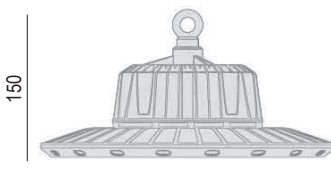
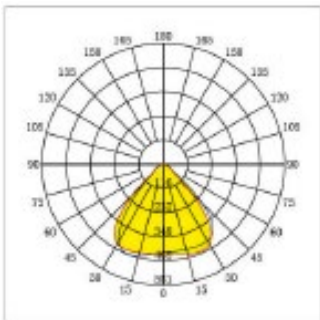

Ø 395

LED Punto 250

Color	Diffusor	Code
■ Nero Black	□ Vetro Glass	RL2251052

Sorgente Source	<b>LED</b>
Potenza Power	250W
Temperatura di colore Color temperature	4000K
Flusso luminoso Lighting output	27.500Lm
Peso (kg) Weight (kg)	4,20

⊕ CE I K08 IP65 CRI>80 CELL

100-264V 50/60Hz



NEW 2025

3 CCT (3000 / 4000 / 6000K)



# BASIC series LED Punto Highbay 3 Power (100 / 150 / 200W)

LED Punto Highbay è un apparecchio progettato per fornire un'illuminazione uniforme per applicazioni industriali ed è una soluzione ideale per altezze di montaggio più elevate, applicazioni ad alta temperatura e industria pesante speciale.

Colore nero RAL 9004.

Ottica: diffusante 90°

Schermo: in policarbonato resistente agli shock termici e agli urti.

Sorgente LED SMD: incorporato con temperatura di colore 3000/4000/6000K; altre temperature di colore a richiesta.

Driver: incorporato fattore di potenza: ≥0,9

*Punto Highbay Led is a luminaire designed to provide uniform lighting for industrial application and is an ideal solution for higher mounting heights, high temperature applications and special heavy-duty industry.*

*RAL 9004 black color.*

*Optic: diffused 90°*

*Shield: in polycarbonate resistant to thermal shocks and collisions*

*Light source SMD LED: included with color temperature 3000/4000/6000K; other color temperatures available on demand.*

*Driver: included Power factor: ≥0,9*

### Installation - Installation

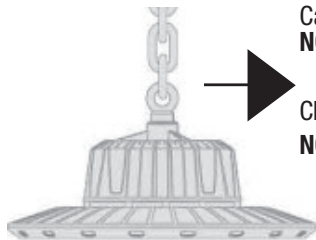

Catena per applicazione in sospensione  
**NON INCLUSO**

Chain for suspension application  
**NOT INCLUDED**



Dissipatore di calore in alluminio pressofuso per un'eccellente dissipazione del calore e resistenza alla corrosione.

Die-cast aluminum heat sink for excellent heat dissipation and strength to corrosion.

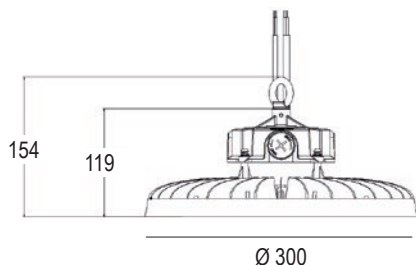
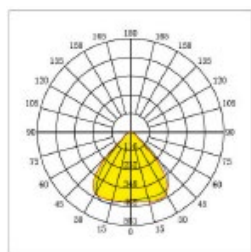

**150 lm/W**



Floodlight

### LED Punto 6

Color	Diffusor	Code
Nero Black	Policarbonato Polycarbonate	RL225106X1
Sorgente Source	Taratura di fabbrica Factory setting	
Potenza Power	100W-150W-	<b>200W</b>
Temperatura di colore Color temperature	3000K-4000K-	<b>6000K</b>
Flusso luminoso Lighting output	150Lm/W	
Peso (kg) Weight (kg)	1,70	



CE IK08 IP65 CRI>80 CELL

100-264V 50/60Hz

# LED Zeus ATEX 2-22



**Installazione:** a parete o a sospensione.

**Corpo e telaio:** in alluminio pressofuso UNI EN 1706 verniciato con polvere termoindurente poliesteri.

**Staffa di fissaggio:** in acciaio, verniciata con polvere termoindurente poliesteri, con goniometro graduato per un corretto puntamento del fascio luminoso.

**PG:** pressacavo in metallo M20x1,5 ATEX PA66 (cavo Ø 10÷14mm<sup>2</sup>)

**Verniciatura:** di tipo poliesteri eseguita a polvere, resistente agli agenti atmosferici, alla corrosione e alla nebbia salina. Grigio RAL 9007

**Ottica:** semi concentrante realizzata in PMMA resistente ai raggi UV

**Schermo:** vetro temprato di spessore 4mm resistente agli shock termici e agli urti.

**Protezione alle sovratensioni inclusa:**

Modo differenziale 6kV (L-N)

Modo comune 10kV (L-GND, N-GND, L&N-GND)

**Sorgente:** LED LUMILEDS 5050

Mantenimento del flusso luminoso minimo al 90% - 100.000h (L90B10) per il 90% dei LED.

**Temperatura di colore:** 4000K;

**Driver:** incorporato  0-10V.

Fattore di potenza ≥0,95.

*Installation: on the wall or suspended.*

*Housing and frame: made by UNI EN 1706 Die-cast aluminum, coated with polyester thermoset powder.*

*Fixing bracket: made by stainless steel, coated with polyester thermoset powder, with graduated goniometer to allow the correct orientation of light beam*

*Metal cable glands: screwed M20x1,5 (Cable Ø 10÷14mm<sup>2</sup>)*

*Coating: coated with powdered polyester, resistant to atmospheric agents and corrosion and guaranteed in saline mist. RAL Grey 9007*

*Optic: semi-clumping made in PMMA resistant to UV radiation*

*Shield: tempered glass with 4mm thickness resistant to thermal shocks and collisions.*

**Protection against overvoltages included:**

Differential mode 6kV (L-N)

Standard mode 10kV (L - GND, N-GND, L&N-GND)

**Light source:** LED LUMILEDS 5050

Maintenance of minimum luminous flux to 90% - 100.000h (L90B10) for 90% of LED.

**Color temperature:** 4000K;

**Driver:** included  0-10V.

Power factor ≥0,95

**IEP** | ENERGY PETROLEUM INSTITUTE

**IEP ATEX**

(1) **Type Examination Certificate**

(2) Equipment or Protective Systems Intended for use in Potentially Explosive Atmospheres  
Directive 2014/34/EU

(3) Type Examination Certificate Number: IEP 20 ATEX 0848

(4) Equipment: LED Zeus Type , Led Lighting Fixtures

(5) Firm Name: RELCO S.R.L.

(6) Firm Address: Via delle Azaiee 6/A - 20090 Buccinasco (MI) - ITALY

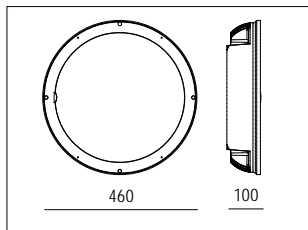
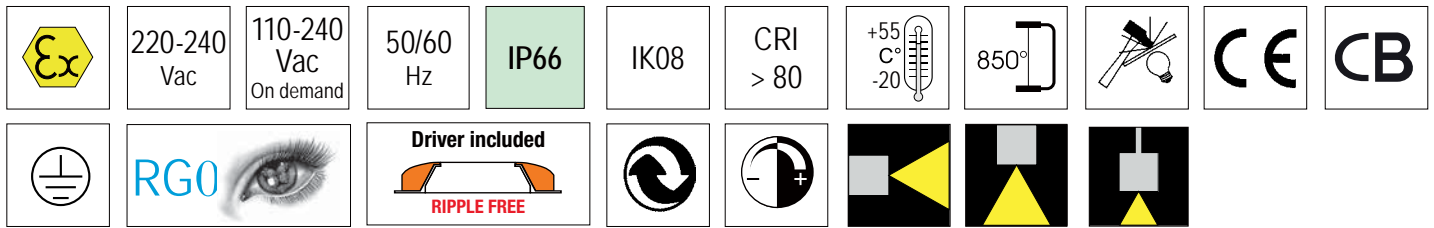

	colour	W	angle	K	nominal lm tc = 25°C	lm output	lm/W	pcs	Kg	CELL
1-10Vdc	G	175	50°	4000	23.100	21.000	120	1	9,70	334087.185ATX
1-10Vdc	G	210	50°	4000	27.700	25.200	120	1	9,70	334087.210ATX

A richiesta: potenze, ottiche e colorazione del LED diverse da quelle standard  
*On demand: powers, optics and LED colours different from the standard ones*

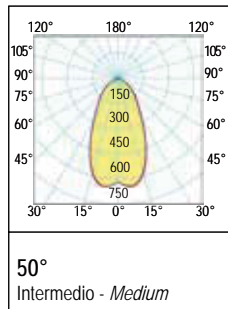

Protezione contro le atmosfere esplosive <i>Protection against explosive atmospheres</i>	CE Ex II 3G Ex nR IIC T4 Ge
Zona pericolosa ammessa <i>Hazardous area allowed</i>	CE Ex II 3D Ex tc IIIC T135° C Dc IP66 Zona 2 - Zone 2 Zona 22 - Zone 22
Normative di riferimento <i>Standard references</i>	EN60079-0 / EN60079-15 EN60079-31 / EN60079-28
Use: the light fitting is suitable for the environment with a danger of explosion of gas, dust and combustible fumes. The light fittings meet the requirements of Government Decree 116/2016 Coll. and European Community Directive N°. 2014/34/EU.	

LED Zeus ATEX viene fornito completo di gancio per applicazione a sospensione

*LED Zeus ATEX comes complete with hook for application to suspension*

**Accessori non inclusi - Not Included accessories**

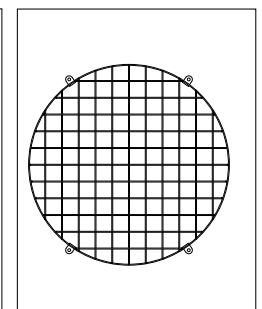
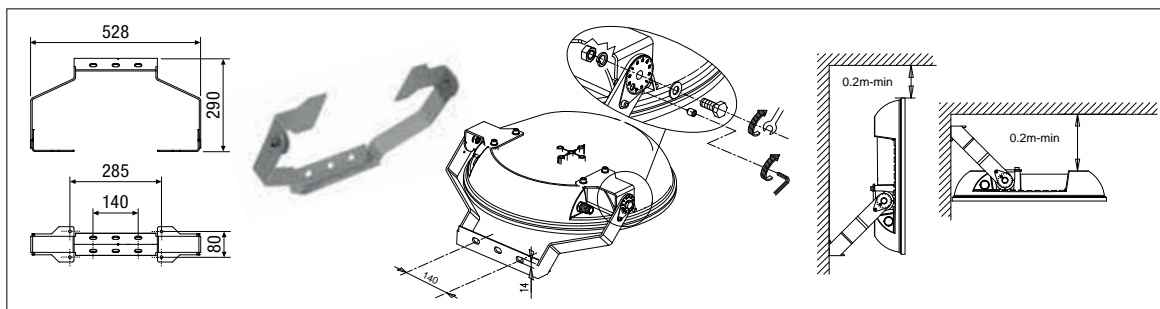

Code: 703959.0101  
 Staffa sagomata orientabile per montaggio a parete più goniometro per puntamento proiettore  
*Shaped adjustable bracket for wall mounting complete with protractor pointing to the projector*

Code: 800016.0101  
 Griglia di protezione  
*Protection grid*

# LED AGP Evolution ATEX 2-22



Proiettore da incasso, parete e plafone particolarmente adatto per magazzini, garage, stazioni di servizio e luoghi con atmosfera potenzialmente esplosiva. Completo di alimentatore elettronico.

**Installazione:** ad incasso, parete e plafone

**Corpo e telaio:** in alluminio pressofuso

**Verniciatura:** di tipo poliestere eseguita a polvere, resistente agli agenti atmosferici e alla corrosione. Colore Bianco RAL 9003.

**PG:** pressacavo in metallo M16 (cavo Ø 4÷8mm<sup>2</sup>)

**Ottica:** diffondente realizzata in PMMA resistente ai raggi UV

**Sorgente:** LED **PHILIPS** lumileds

Mantenimento del flusso luminoso minimo al 90% - 100.000h (L90B10) per il 90% dei LED

**Driver:** incorporato

Fattore di potenza ≥ 0,95.

*Recessed flood light particularly suitable for warehouses, garages, service stations and places in general with potentially explosive atmosphere. Complete with electronic ballast.*

**Installation:** recessed, wall and ceiling

**Body and frame:** die cast aluminum

**Coating:** coated with powdered polyester, resistant to atmospheric agents and corrosion. White colour RAL 9003

**PG:** M16 metal cable gland (cable 4÷8mm<sup>2</sup>)

**Optic:** wide made of UV-resistant PMMA

**Light source:** LED **PHILIPS** lumileds  
Maintenance of minimum luminous flux to 90% - 100.000h (L90B10) for 90% of LED.

**Driver:** certified.

Power factor ≥ 0,95.

Use: the light fitting is suitable for the environment with a danger of explosion of gas, dust and combustible fumes. The light fittings meet the requirements of Government Decree 116/2016 Coll. and European Community Directive N°. 2014/34/EU.

Floodlight



	100-277 Vac	50/60 Hz	IP66	IK10	CRI > 70	+55 C -20	850°
				<b>Driver included</b>  RIPPLE FREE			

colour	W	angle	K	nominal Im tc = 25°C	Im output	lm/W	pcs	Kg	CELL
[B]	100	120°	4000	18.400	16.000	160	1	4,00	RL04-100
[B]	150	120°	4000	26.700	23.250	155	1	4,00	RL04-150

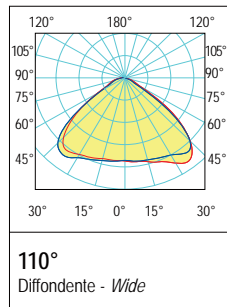
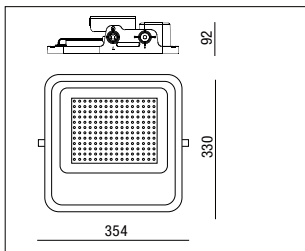

Protezione contro le atmosfere esplosive <i>Protection against explosive atmospheres</i>	II 2G Ex ib IIC T6
Zona pericolosa ammessa <i>Hazardous area allowed</i>	Zona 2 - Zone 2 Zona 22 - Zone 22
Normative di riferimento <i>Standard references</i>	EN 60079-0:2012/A11:2013 EN 60079-11:2012 EN60079-31:2014

## PROMOTION

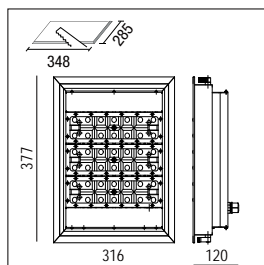
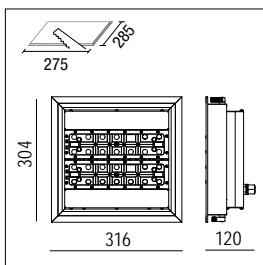

colour	W	angle	K	nominal Im tc = 25°C	Im output	lm/W	pcs	Kg	CELL	QTY	Euro Netto
[S]	100	110°	5000	18.000	15.000	150	1	9,70	334096.100ATX	100	100,00
[S]	150	110°	5000	27.000	25.000	150	1	9,70	334096.150ATX	38	100,00

Only recessed

# LED AGP Evolution ATEX 2-22

## Accessori non inclusi - *Not included accessories*



**Cod. RL04/PL**  
 Accessorio per installazione a plafone  
*Accessory for ceiling installation*



**Cod. RL04/R**  
 Accessorio per installazione a incasso  
*Accessory for recessed installation*  
 Dimensioni - *Dimensions*: 400x400mm



**Cod. RL04/S**  
 Accessorio staffa  
*Bracket accessory*



**Cod. 703952.NEW**  
 Attacco palo per 1 o 2 proiettori, Ø60/76mm  
*Pole attachment for either 1 or 2 floodlights, size Ø 60/76mm.*

### Application example

Accessory for recessed application



Accessory for ceiling application



Bracket accessory



180 Lm/W

Innovativi proiettori a LED progettati per illuminare campi sportivi, stadi, aree di parcheggio, aeroporti, logistiche e grandi aree in genere.

**Installazione:** sospensione, parete/plafone e testa palo (completo di staffa di fissaggio).

**Corpo e telaio:** in alluminio e acciaio verniciato con polvere termoindurente poliester.

**Staffa di fissaggio:** in acciaio, verniciata con polvere termoindurente poliester.

**Verniciatura:** di tipo poliester eseguita a polvere, resistente agli agenti atmosferici e alla corrosione marina. Colore Grigio RAL 9007.

**Ottica:** concentrante, semi concentrante, diffondente e asimmetrica.

**Lenti:** PMMA autoestinguenti antiurto

**Sorgente:** LED SMD 5050 LUMILEDS

**Temperatura di colore:** 4000K; a richiesta (2200K - 2700K - 3000K - 5000K - Consegna 90 giorni).

**Protezione alle sovratensioni inclusa:**

Modo differenziale 6kV (L-N)

Modo comune 10kV (L-GND, N-GND, L&N-GND)

Mantenimento del flusso luminoso minimo al 80% - 50.000h (L80B10) per il 90% dei LED.

**LED Driver:**  Conforme alla Norma: IEC 61000-4-5.

Fattore di potenza:  $\geq 0,98$

*Innovative LED projectors designed to light up sport fields, stadiums, car parks, airports and wide spaces in general.*

*Installation: on vertical and horizontal surfaces (complete with fixing bracket)*

*Housing and frame: made by UNI EN 1706 die-cast aluminum, coated with polyester thermoset powder*

*Fixing bracket: made by stainless steel, coated with polyester thermoset powder, with graduated goniometer to allow the correct orientation of light beam*

*Coating: coated with powdered polyester, resistant to atmospheric agents and marine corrosion.*

*Grey colour RAL 9007*

*Optic: clumping, semi-clumping, diffused and asymmetric*

*Shield: tempered glass with 4mm thickness resistant to thermal shocks and collisions*

*Light source: LED SMD 5050 LUMILEDS*

*Color temperature: 4000K; on demand (2200K - 2700K - 3000K - 5000K. Delivery time: 90 days)*

*Protection against overvoltages included:*

*Differential mode 6kV (L-N)*

*Standard mode 10kV (L - GND, N-GND, L&N-GND).*

*Maintenance of minimum luminous flux to 80% - 50.000h (L80B10) for 90% of LED.*

*LED Driver: . Conforming to IEC 61000-4-5.*

*Power factor:  $\geq 0,98$  EN61547*

# LED Lampo Logistica S



**NEW**

100-240 Vac	110 Vac On demand	50/60 Hz	<b>IP66</b>	IK10	+55°C -20°C	850°				Driver included <b>RIPPLE FREE</b>
CRI > 80										

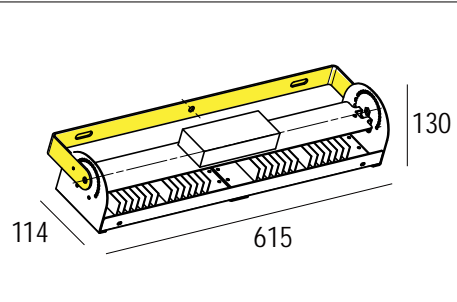
# LED Lampo Logistica S 2



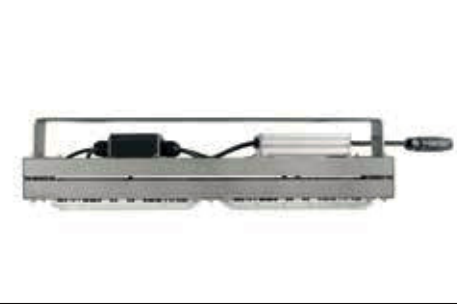

114      615      130



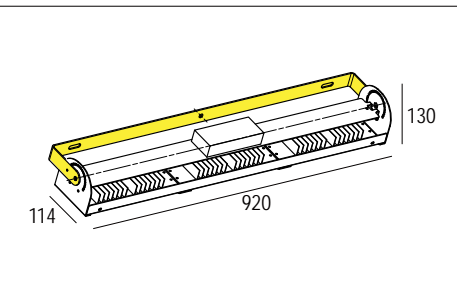

	colour	W	Optic	K	nominal lm tc = 25°C	lm output	lm/W	Kg	CELL
	G	100	25°	4000	20.350	18.000	180	2,90	LALOG10025
	G	100	40°	4000	20.350	18.000	180	2,90	LALOG10040
	G	100	90°	4000	20.350	18.000	180	2,90	LALOG10090
		G	100	25°	4000	20.350	180	2,90	LALOG10025DA
		G	100	40°	4000	20.350	180	2,90	LALOG10040DA
		G	100	90°	4000	20.350	180	2,90	LALOG10090DA

# LED Lampo Logistica S 3

114      920      130





	colour	W	Optic	K	nominal lm tc = 25°C	lm output	lm/W	Kg	CELL
	G	150	25°	4000	30.500	27.000	180	3,60	LALOG15025
	G	150	40°	4000	30.500	27.000	180	3,60	LALOG15040
	G	150	90°	4000	3.500	27.000	180	3,60	LALOG15090
		G	150	25°	4000	27.000	180	3,60	LALOG15025DA
		G	150	40°	4000	27.000	180	3,60	LALOG15040DA
		G	150	90°	4000	27.000	180	3,60	LALOG15090DA

Waterproof luminaires

# LED Lampo Logistica S

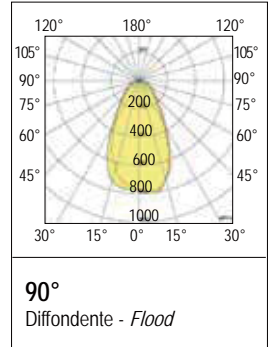
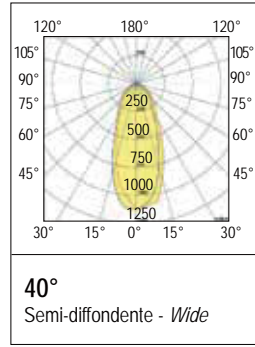
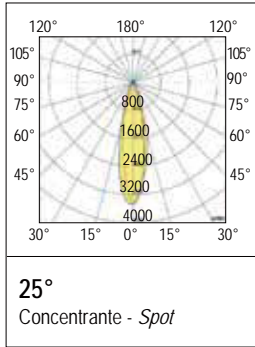
**NEW**



Waterproof luminaires

# LED Allegra Plus

145 Lm/W



Apparecchi di illuminazione a LED per applicazioni a luce diffusa da interno e da esterno. Le elevate prestazioni illuminotecniche consentono a questi apparecchi di illuminazione di poter essere collocati in molteplici campi applicativi quali ad esempio, aree comuni, negozi, magazzini anche dove sia richiesto un elevato indice di protezione alle polveri (6), all'acqua (5) ed agli urti (8).

**Installazione:** a soffitto o a sospensione

**Corpo:** in policarbonato grigio infrangibile stabilizzato ai raggi UV. Colore Grigio RAL 7038

**Ganci e viteria:** in acciaio Inox

**Cavo:** privo di alogenuri

**Diffusore:** in policarbonato semi-opale di ottima qualità, autoestinguente V2 stabilizzato ai raggi UV

**Conforme alla norma:** EN62471: 2008, sicurezza fotobiologica delle lampade e sistemi di lampade.

**Driver:** incluso nel sistema > 50.000 h

Fattore di potenza  $\geq 0,95$ .

**Sorgente:** LED LG. Mantenimento del flusso luminoso minimo al 80% - 80.000h (L80B20).

**Temperatura di colore:** 4000K. Altre temperature di colore a richiesta (2200K - 2700K - 3000K - 5000K - Consegna: 60 giorni).

**A richiesta:** con rilevatore di movimento a microonde con crepuscolare - Cod. BC360A-D02

**Norme di riferimento**

EN60598-1; EN60598-2-1; EN62471

EN62031; EN60598-2-5; EN61547

*LED lighting fixtures for indoor and outdoor diffused light applications. Thanks to their high lighting performance, these fixtures can be used in a number of applications, such as common areas, shops and warehouses but also where high protection from dust (6), water (5) and shocks (8) is required.*

**Installation:** ceiling or suspended

**Housing:** high quality semi-opal polycarbonate, self-extinguishing V2 stabilized against UV rays. Grey RAL 7038

**Hooks and screws:** in stainless steel

**Cable:** halogen free

**Diffuser:** made by semi-opal polycarbonate

**Complying to standard:** EN62471: 2008, photobiological safety of lamps and lamp systems

**Driver:** included included in the system > 50.000 h

Power factor  $\geq 0,95$ .

**Source:** LED LG. Maintenance of minimum luminous flux to 80% - 80.000h (L80B20).

**Color temperature:** 4000K. (other color temperatures on demand (2200K - 2700K - 3000K - 5000K - Delivery time: 60 days).

**On demand:** with microwave motion detector with crepuscular - Cod. BC360A-D02

**Standard references**

EN60598-1; EN60598-2-1; EN62471

EN62031; EN60598-2-5; EN61547

La certificazione fotometrica dei nostri apparecchi viene sempre effettuata da un istituto esterno. Efficienza luminosa e "Im Output" sono quindi il risultato di tale istituto.

*The photometric certification of our appliances is always carried out by an external institute. Luminous efficiency and "Im Output" are therefore the result of this institute.*

A richiesta - On demand

Sensor )))

Sensor DIM  
1-10V

Sensor DIM  
DALI

220-240 Vac	50/60 Hz	110 Vac On demand	IP66	IK09 Body	IK10 Diffusor	CRI > 80	+40 C° -20	CE	17	
850°		TECEE	RG0	LOW FLICKER	Driver included MULTIPOWER					

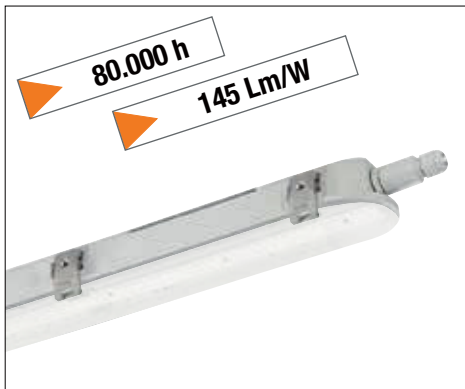

colour	W	L (mm)	Optic	K	lm output	lm/W	pcs	Kg	CELL
G	20	650	110°	4000	2900	145	1	1,70	32003/H
G	36	1220	110°	4000	5220	145	1	1,70	32002/H
G	45	1220	110°	4000	6520	145	1	1,70	32030/H
G	54	1560	110°	4000	7800	145	1	2,40	32031/H
G	65	1560	110°	4000	9400	145	1	2,40	32031/60/H

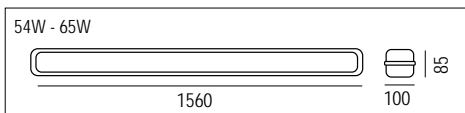
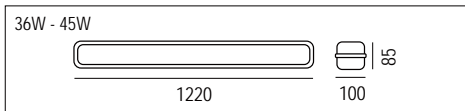
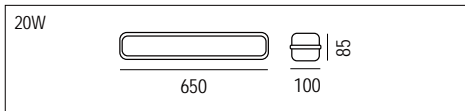

colour	W	L (mm)	Optic	K	lm output	lm/W	pcs	Kg	CELL-E
G	20	650	110°	4000	2900	145	1	1,90	32003/H/EMER
G	36	1220	110°	4000	5220	145	1	1,90	32002/H/EMER
G	45	1220	110°	4000	6520	145	1	2,20	32030/H/EMER
G	54	1560	110°	4000	7800	145	1	2,60	32031/H/EMER
G	65	1560	110°	4000	9400	145	1	2,60	32031/60/H/EM



**AUTOESTINGUENZA:** LED Allegra Plus è realizzata in un materiale plastico in classe V2. Con questo materiale il corpo lampada si spegnerà entro 25".

**FILO INCANDESCENTE:** LED Allegra Plus è resistente alla prova del filo incandescente per 850°C.

**SELF-EXTINGUISHING:** LED Allegra Plus is made of a plastic material in class V2. With this material the specimen will turn off within 25".

**INCANDESCENT WIRE:** LED Allegra Plus is resistant to the glow wire test for 850 °C.

colour	W	L (mm)	Optic	K	lm output	lm/W	pcs	Kg	CELL
G	36	1220	110°	4000	5220	145	1	1,70	32002/H/DALI
G	45	1220	110°	4000	6520	145	1	1,70	32030/H/DALI
G	54	1560	110°	4000	7800	145	1	2,40	32031/H/DALI
G	65	1560	110°	4000	9400	145	1	2,40	32031/60/H/DA

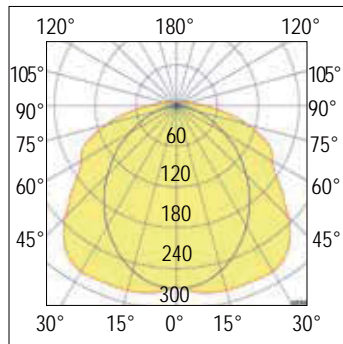

**110°**  
Diffondente - Wide

colour	W	L (mm)	Optic	K	lm output	Lm/W	pcs	Kg	CELL-E
G	45	1220	110°	4000	6520	145	1	2,20	32030/H/EM/DA
G	54	1560	110°	4000	7800	145	1	2,60	32031/H/EM/DA

# LED Allegra Plus

## Accessori inclusi - Included accessories



Tasselli e viti non compresi.  
Plug and screws are not included.



Kit per montaggio a parete/plafone e sospensione.  
Wall/Ceiling and suspension mounting kit.



Staffa di fissaggio a parete/plafone in acciaio inox. Per l'installazione a parete o soffitto utilizzare tasselli e viti adeguati alla superficie su cui andrà ancorata.  
Wall/ceiling fixing bracket made by stainless steel. For ceiling or wall installation use plug and screws adapted to surface upon which it will be anchored.

## Accessoria richiesta - Upon request accessories

Code: 3001.580

Griglia di protezione LED Allegra Plus 54W - LED Allegra Plus 65W - Protection grille LED Allegra Plus 54W - LED Allegra Plus 65W

## Linea passante (aggiungere /S dopo il codice) - with through-wiring (add /S after the code)

N° massimo di apparecchi collegabili per ogni linea elettrica Maximum number of devices that can be connected to any electrical line	
W Potenza - Power	N° massimo di apparecchi Maximum number of device
20	65
36	40
45	30
54	26
65	20



N.B. Corrente di spunto = 25A per 200µs per ogni apparecchio  
N.B. Inrush current = 25A for 200µs each

Prezzo: + 30,00 Euro al prezzo lordo standard di listino  
Price: + 30,00 Euros to the list price

## Luce solo all'occorrenza - Light only when needed

A richiesta - On demand

1-10Vdc

DALI 2



Rilevatore di MOVIMENTO a microonde con crepuscolare per impostazione soglia Lux ambiente di intervento, questa tecnologia consente di "nascondere" il rilevatore anche all'interno di corpi lampada infatti esso emette onde elettromagnetiche ad alta frequenza (5.8GHz) e riceve il loro eco, in questo modo è in grado di riconoscere una qualsiasi variazione data da un oggetto non rilevato nella precedente analisi e verrà dato il comando di ON. La trasmissione ad alta frequenza è <10mW e risulta essere 100 volte inferiore alle emissioni di un comune telefono cellulare o di un forno a microonde che emettono mediamente 1000mW.

Installazione: da incorporare

Microwave MOTION detector with crepuscular. This technology allows the detector to be "hidden" within lamp bodies, in fact it emits electromagnetic waves at a high frequency (5.8GHz) and receives their echoes. In this way, it can recognise any variation given by an object not detected in the previous analysis and the ON command will be given. High frequency transmission is <10mW and is 100 times lower than the emissions of a common mobile phone or a microwave oven emitting an average of 1000mW.

Installation: built-in use



Versione con sensore di rilevamento a distanza Radar Control

ON/OFF. Aggiungere Y dopo il codice - es. 32030/HY. Più Euro 30,00 dal prezzo di listino

Version with remote detection sensor Radar control ON/OFF.

Add Y after the code - ex. 32030/HY). + 30,00 Euros from the list price

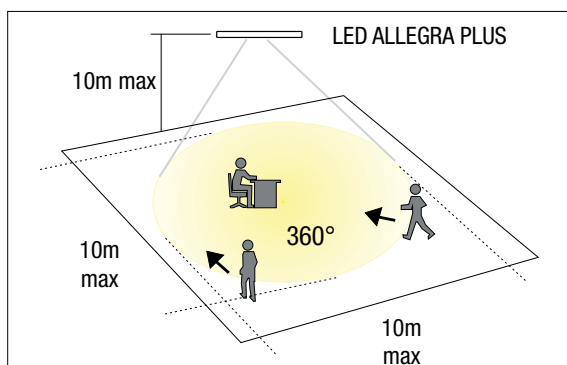

160 Lm/W



**A richiesta - On demand:**  
**Cablaggio con linea passante**  
**Prepared for loop in - loop out**

**DALI 2 PUSH**

**Emergency**

**Sensore di rilevamento**  
**Movement Detector**

Waterproof luminaires

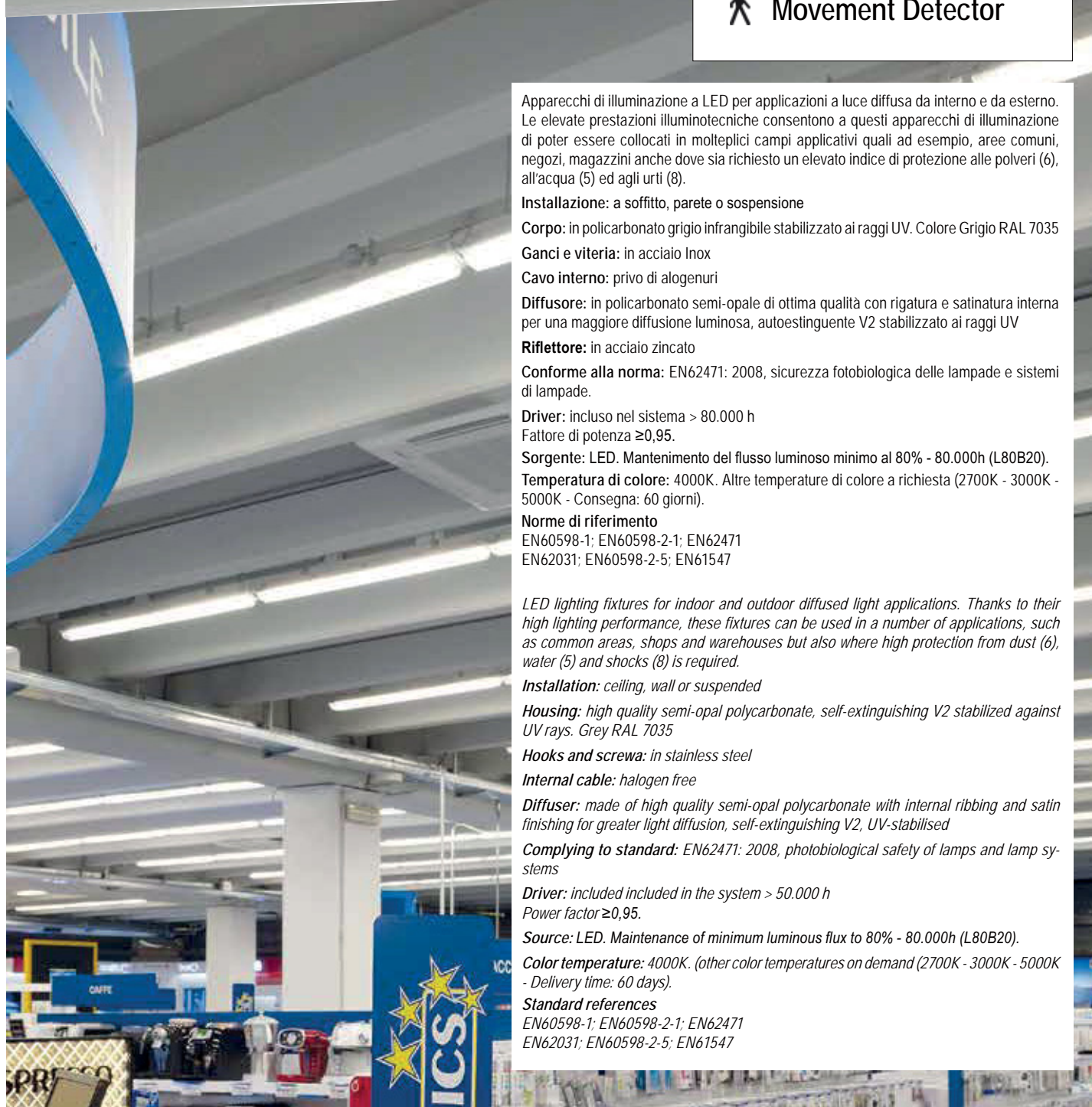

Apparecchi di illuminazione a LED per applicazioni a luce diffusa da interno e da esterno. Le elevate prestazioni illuminotecniche consentono a questi apparecchi di illuminazione di poter essere collocati in molteplici campi applicativi quali ad esempio, aree comuni, negozi, magazzini anche dove sia richiesto un elevato indice di protezione alle polveri (6), all'acqua (5) ed agli urti (8).

**Installazione:** a soffitto, parete o sospensione

**Corpo:** in policarbonato grigio infrangibile stabilizzato ai raggi UV. Colore Grigio RAL 7035

**Ganci e viteria:** in acciaio Inox

**Cavo interno:** privo di alogenuri

**Diffusore:** in policarbonato semi-opale di ottima qualità con rigatura e satinatura interna per una maggiore diffusione luminosa, autoestinguento V2 stabilizzato ai raggi UV

**Riflettore:** in acciaio zincato

**Conforme alla norma:** EN62471: 2008, sicurezza fotobiologica delle lampade e sistemi di lampade.

**Driver:** incluso nel sistema > 80.000 h

Fattore di potenza  $\geq 0,95$ .

**Sorgente:** LED. Mantenimento del flusso luminoso minimo al 80% - 80.000h (L80B20).

**Temperatura di colore:** 4000K. Altre temperature di colore a richiesta (2700K - 3000K - 5000K - Consegna: 60 giorni).

**Norme di riferimento**

EN60598-1; EN60598-2-1; EN62471

EN62031; EN60598-2-5; EN61547

*LED lighting fixtures for indoor and outdoor diffused light applications. Thanks to their high lighting performance, these fixtures can be used in a number of applications, such as common areas, shops and warehouses but also where high protection from dust (6), water (5) and shocks (8) is required.*

**Installation:** ceiling, wall or suspended

**Housing:** high quality semi-opal polycarbonate, self-extinguishing V2 stabilized against UV rays. Grey RAL 7035

**Hooks and screws:** in stainless steel

**Internal cable:** halogen free

**Diffuser:** made of high quality semi-opal polycarbonate with internal ribbing and satin finishing for greater light diffusion, self-extinguishing V2, UV-stabilised

**Complying to standard:** EN62471: 2008, photobiological safety of lamps and lamp systems

**Driver:** included included in the system > 50.000 h

Power factor  $\geq 0,95$ .

**Source:** LED. Maintenance of minimum luminous flux to 80% - 80.000h (L80B20).

**Color temperature:** 4000K. (other color temperatures on demand (2700K - 3000K - 5000K - Delivery time: 60 days).

**Standard references**

EN60598-1; EN60598-2-1; EN62471

EN62031; EN60598-2-5; EN61547

220-240 Vac	50/60 Hz	IP66	IP69	IK10	CRI > 80	+40 C -20	CE		850°	
L80 B20		RG0	LOW FLICKER	Driver included <b>MULTIPOWER</b>	HACCP					

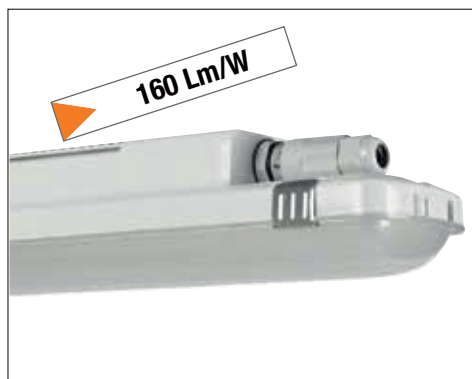

24W - 30W - 36W - 45W

37W - 46W - 55W - 70W



**AUTOESTINGUENZA:** LED Allegra + è realizzata in un materiale plastico in classe V2. Con questo materiale il corpo lampada si spegnerà entro 25".

**FILO INCANDESCENTE:** LED Allegra + è resistente alla prova del filo incandescente per 850°C.

**SELF-EXTINGUISHING:** LED Allegra + is made of a plastic material in class V2. With this material the specimen will turn off within 25".

**INCANDESCENT WIRE:** LED Allegra + is resistant to the glow wire test for 850 °C.

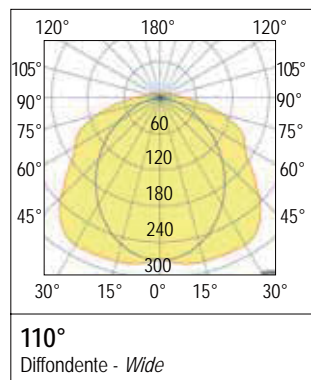

colour	W Max	L (mm)	Optic	K	lm output max	lm/W	pcs	Kg	CELL
G	45	1200	110°	4000	7200	160	1	1,70	PIU42
G	70	1500	110°	4000	11200	160	1	1,70	PIU65

È possibile intervenire per il cambio batteria - It is possible to intervene for the battery change

colour	W Max	L (mm)	Optic	K	lm output max	lm/W	pcs	Kg	CELL
G	45	1200	110°	4000	7200	160	1	1,70	PIU42EM
G	70	1500	110°	4000	11200	160	1	1,70	PIU65EM

**DALI 2**

colour	W Max	L (mm)	Optic	K	lm output max	lm/W	pcs	Kg	CELL
G	45	1200	110°	4000	7200	160	1	1,70	PIU42DA
G	70	1500	110°	4000	11200	160	1	1,70	PIU65DA

**DALI 2**



È possibile intervenire per il cambio batteria  
It is possible to intervene for the battery change

colour	W Max	L (mm)	Optic	K	lm output max	lm/W	pcs	Kg	CELL
G	45	1200	110°	4000	7200	160	1	1,70	PIU42DAEM
G	70	1500	110°	4000	11200	160	1	1,70	PIU65DAEM

LED Driver multipotenza incluso LED Driver multipower included		
1200mm		
I mA	W	Lm Output
200	24	3840
250	30	4800
300	36	5760
350	45	7200

LED Driver multipotenza incluso LED Driver multipower included		
1500mm		
I mA	W	Lm Output
200	37	5920
250	46	7360
300	55	8800
350	70	11200

Taratura di fabbrica - Factory setting

Alimentazione regolabile su 4 step di flusso luminoso per adattare il prodotto a tutte le esigenze Power supply adjustable on 4 steps of light flow to adapt the product to all needs

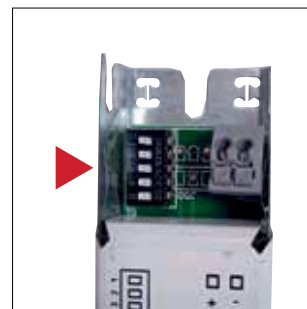
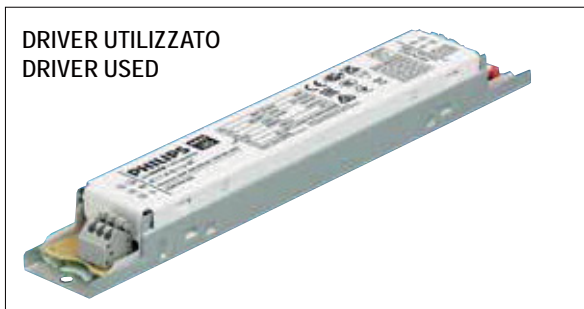

Waterproof luminaires

Connettore presa spina incluso  
Plug socket connector included



Tappo di chiusura incluso  
Closing cap included



La staffa in acciaio inox fornita di serie consente l'installazione facile e sicura dell'apparecchio a soffitto o parete. Il gancio a molla consente il collegamento rapido a qualsiasi sistema di sospensione a catena.

*The stainless steel bracket supplied as standard allows easy and safe installation of the luminaire on the ceiling or wall. The spring hook allows for quick connection to any chain suspension system.*



Accessori inclusi - *Included accessories*



Predisposto per cablaggio in fila continua (aggiungere S dopo il codice  
+ Euro 30,00 dal prezzo di listino)

*Prepared for continuous line wiring (add to S after the code,  
+ 30,00 Euros from the list price)*



#### **Assemblaggio in fila continua**

La lampada è dotata di speciali "dentini" di allineamento che permettono il perfetto allineamento delle strutture, il collegamento al morsetto rapido è invisibile alla vista, rendendoli discreti.

#### ***Continuous row assembly***

*The device is equipped with special alignment "teeth" which allow perfect alignment of the frameworks, the connection to the quick clamp is invisible to the eye, making them discreet.*

# LED Allegra + HIGH PERFORMANCE / HIGH EFFICIENCY

**N° massimo di apparecchi collegabili per ogni linea elettrica**  
**Max number of device that can be connected to any electrical line**

W Potenza - Power	N° massimo di apparecchi Maximum number of device
24	65
36	40
45	30
55	26
65	20

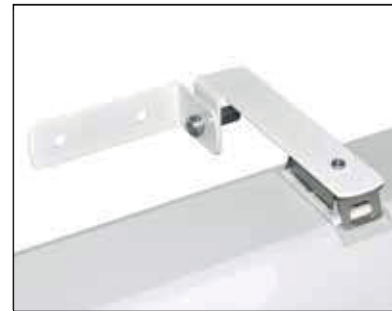

Staffa parete - Wall bracket  
Cod. PIUSTAFFA



Clips in acciaio per apertura e chiusura della lampada.  
 È possibile intervenire per il cambio batteria  
 Steel clips for opening and closing the lamp  
 It is possible to intervene for the battery change

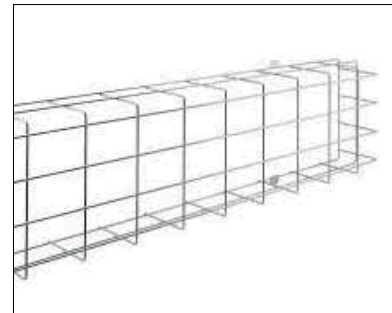

Griglia di protezione - Protection grid  
Cod. PIUGRIGLIA

**Luce solo all'occorrenza - Light only when needed**

A richiesta - On demand **1-10Vdc** **DALI 2**



Rilevatore di MOVIMENTO a microonde con crepuscolare per impostazione soglia Lux ambiente di intervento, questa tecnologia consente di "nascondere" il rilevatore anche all'interno di corpi lampada infatti esso emette onde elettromagnetiche ad alta frequenza (5,8GHz) e riceve il loro eco, in questo modo è in grado di riconoscere una qualsiasi variazione data da un oggetto non rilevato nella precedente analisi e verrà dato il comando di ON.

*Microwave MOTION detector with crepuscular. This technology allows the detector to be "hidden" within lamp bodies, in fact it emits electromagnetic waves at a high frequency (5.8GHz) and receives their echoes. In this way, it can recognise any variation given by an object not detected in the previous analysis and the ON command will be given.*



Versione **con sensore di rilevamento a distanza Radar Control ON/OFF**. Aggiungere "EYE" dopo il codice es. PIU42EYE. Più Euro 40,00 dal prezzo di listino

*Version with remote detection sensor Radar control ON/OFF.*

*Add "EYE" after the code - ex. PIU42EYE. + 40,00 Euros from the list price*

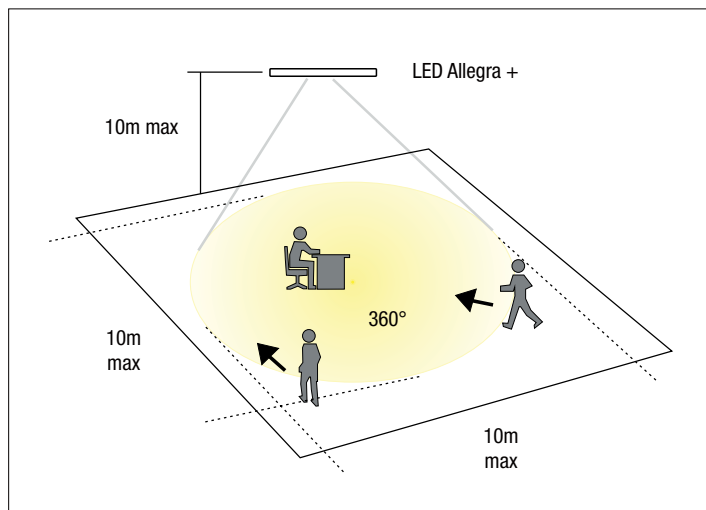

Waterproof luminaires

# BASIC series LED Allegra Basic 3CCT

**7 in 1**

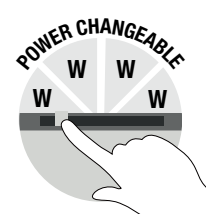
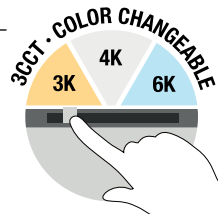

32003/3C - 18W

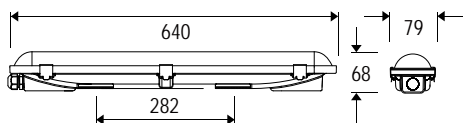

32002/3C - 40W

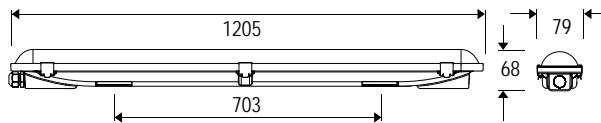

32031/3C - 55W

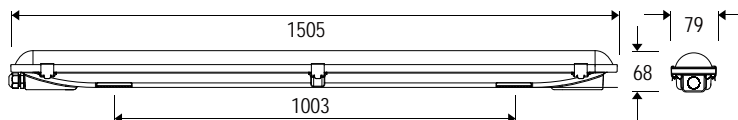

Waterproof luminaires



## Caratteristiche

- Temperatura di colore 3000K, 4000K e 6000K nello stesso corpo e regolabile tramite selettore.
- Potenza regolabile tramite selettore sul driver.
- Staffe per montaggio a soffitto e ganci di sospensione inclusi.

**Installazione:** a soffitto o a sospensione.

**Corpo:** in policarbonato grigio RAL 7035 infrangibile stabilizzato ai raggi UV.

**Viteria:** in acciaio Inox AISI 301.

**Ganci:** acciaio inossidabile S/S 301.

**Diffusore:** in policarbonato opale di ottima qualità, autoestinguente V2 stabilizzato ai raggi UV  
Conforme alla norma: EN62471: 2008, sicurezza fotobiologica delle lampade e sistemi di lampade.

**Driver:** incluso nel sistema > 50.000 h

**Fattore di potenza  $\geq 0,95$ .**

**Sorgente:** LED, mantenimento del flusso luminoso minimo al 90% - 50.000h (L80B20).

**Temperatura di colore 3CCT:** 3000K/4000K/6000K

**Norme di riferimento**

EN60598-1; EN60598-2-1; EN62471  
EN62031; EN60598-2-5; EN61547

## Features

- Color temperatures of 3000K, 4000K, and 6000K in the same housing, adjustable via a selector.
- Adjustable power, with a selector on the driver.
- Ceiling mounting brackets and suspension hooks included.

**Installation:** Ceiling or pendant.

**Body:** Shatterproof, UV-stabilized RAL 7035 gray polycarbonate.

**Screws:** AISI 301 stainless steel.

**Hooks:** stainless steel S/S 301.

**Diffuser:** High-quality, self-extinguishing V2 UV-stabilized opal polycarbonate.

**Complies with standard:** EN62471:2008, photobiological safety of lamps and lamp systems.

**Driver:** Included in the system > 50,000 h

**Power factor  $\geq 0.95$ .**

**Light source:** LED, minimum lumen maintenance of 90% - 50,000 h (L80B20).

**3CCT Color Temperature:** 3000K/4000K/6000K

**Reference Standards**

EN60598-1; EN60598-2-1; EN62471  
EN62031; EN60598-2-5; EN61547E

220-240 Vac    50/60 Hz    IP66    IK08    CRI > 80    +45°C / -20°C    CE       850°       RGO

**Driver included**  
  
**MULTIPOWER**

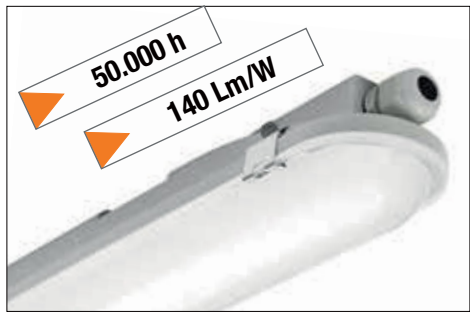
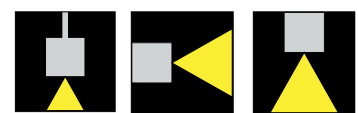

colour	W	Optic	K			lm output	lm/W	pcs	Kg	CELL	
G	max 18	120°	3000	4000	6000	max 2520	140	1	0,75	32003/3C	
G	max 40	120°	3000	4000	6000	max 5600	140	1	1,15	32002/3C	
G	max 55	120°	3000	4000	6000	max 7700	140	1	1,46	32031/3C	

**DALI 2**

colour	W	Optic	K			lm output	lm/W	pcs	Kg	CELL	
G	max 18	120°	3000	4000	6000	max 2520	140	1	0,75	32003/3CDA	
G	max 40	120°	3000	4000	6000	max 5600	140	1	1,15	32002/3CDA	
G	max 55	120°	3000	4000	6000	max 7700	140	1	1,46	32031/3CDA	

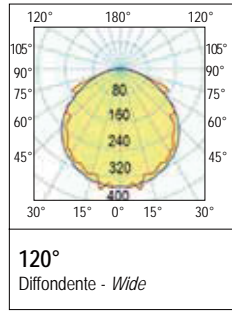

colour	W	Optic	K			lm output	lm/W	pcs	Kg	CELL-E	
G	max 18	120°	3000	4000	6000	max 2520	140	1	0,75	32003/3CEM	
G	max 40	120°	3000	4000	6000	max 5600	140	1	1,15	32002/3CEM	
G	max 55	120°	3000	4000	6000	max 7700	140	1	1,46	32031/3CEM	



**DALI 2**

colour	W	Optic	K			lm output	lm/W	pcs	Kg	CELL-E	
G	max 18	120°	3000	4000	6000	max 2520	140	1	0,75	32003/3CDAEM	
G	max 40	120°	3000	4000	6000	max 5600	140	1	1,15	32002/3CDAEM	
G	max 55	120°	3000	4000	6000	max 7700	140	1	1,46	32031/3CDAEM	



Flusso/potenza regolabili manualmente su 4 step - Flux / power manually adjustable on 4 steps

**LED Driver multipotenza incluso - LED Driver multipower included**

32003/3C - max 18W		32002/3C - max 40W		32031/3C - max 55W	
I mA	W	I mA	W	I mA	W
200	10	200	23	200	31
250	13	250	29	250	39
300	15	300	34	300	47
350	18	350	40	350	55

Per una corretta gestione dell'impianto di illuminazione, bisogna sempre tenere conto sia della necessità di illuminazione realizzato tramite calcolo illuminotecnico, che il rispetto dei consumi energetici.  
I nostri modelli LED Allegra Basic 3CCT permettono di ottenere questo risultato poiché sono dotati di Driver multipower; questi particolari Driver consentono di impostare la corrente in uscita tramite dip-switch, fornendo, di conseguenza, la corretta potenza di lampada in base all'esigenza desiderata, permettendo quindi sia il risparmio energetico che il rispetto del flusso luminoso determinato in fase di progetto.  
*For proper management of the lighting system, it is always necessary to take into account both the need for lighting achieved through lighting engineering calculations, and respect for energy consumption.  
Our Allegra Basic LED models allow to obtain this result as they are equipped with multipower Driver; these particular drivers allow you to set the output current via dip-switches, thus providing the correct lamp power based on the desired need, thus allowing both energy savings and respect for the luminous flux determined in the design phase.*

Taratura di fabbrica - Factory setting

**Accessori inclusi - Included accessories**

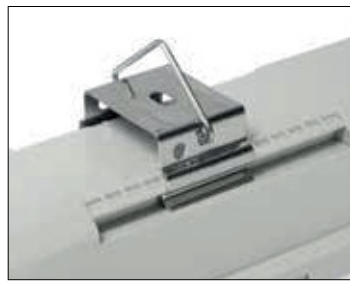

La staffa in acciaio inox fornita di serie consente l'installazione facile e sicura dell'apparecchio a soffitto o parete. Il gancio a molla consente il collegamento rapido a qualsiasi sistema di sospensione a catena.  
*The stainless steel bracket supplied as standard allows easy and safe installation of the luminaire on the ceiling or wall. The spring hook allows for quick connection to any chain suspension system.*



Staffa, viti e tasselli, tappo di chiusura.  
*Bracket, screws and plugs, closing cap.*

Waterproof luminaires

# LED Pupilla sensor DIM

80.000 h

165 Lm/W

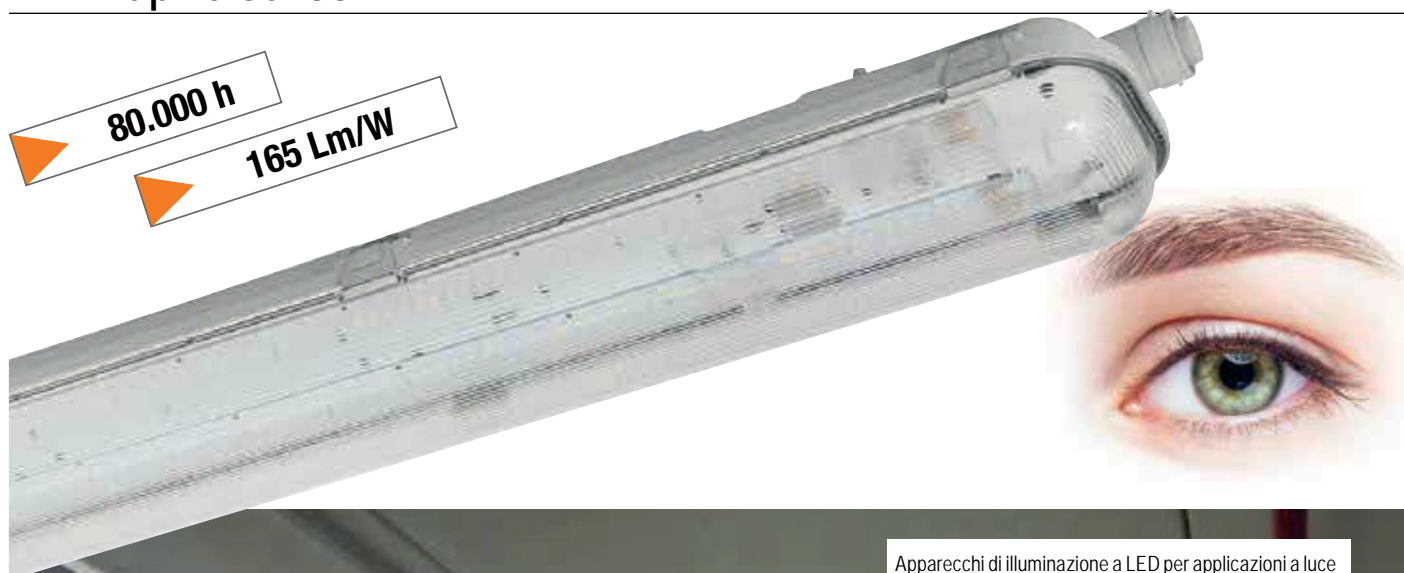

Apparecchi di illuminazione a LED per applicazioni a luce diffusa da interno e da esterno con sensore di presenza/ luminosità integrato nella lampada

**Installazione:** a soffitto o a sospensione

**Corpo:** base in plastica rinforzata con vetro GRP (Glass Reinforced Plastic).

**Ganci e viteria:** in acciaio Inox

**Diffusore:** in policarbonato trasparente (a richiesta in policarbonato semi opale - aggiungere O dopo il codice). Finitura liscia.

**Conforme alla norma:** EN62471: 2008, sicurezza fotobiologica delle lampade e sistemi di lampade.

**Driver:** incluso nel sistema

Fattore di potenza  $\geq 0,90$ .

**Sorgente:** LED LUMILEDS 3528

Mantenimento del flusso luminoso minimo al 80% - 80.000h (L80B20).

**Temperatura di colore:** 4000K. Altre temperature di colore a richiesta (3000K - 5000K - Consegna: 60 giorni).

**Norme di riferimento**

EN60598-1; EN60598-2-1; EN62471

EN62031; EN60598-2-5; EN61547

*LED lighting fixtures for indoor and outdoor diffused light applications with presence / light sensor integrated in the lamp*

**Housing:** in plastic reinforced with GRP glass (Glass Reinforced Plastic).

**Installation:** ceiling or suspended

**Hooks and screws:** in stainless steel

**Diffuser:** made by transparent polycarbonate (in semi-opal polycarbonate on demand - add O after the code). Smooth finish.

**Complying to standard:** EN62471: 2008, photobiological safety of lamps and lamp systems

**Driver:** included included in the system > 50.000 h  
Power factor  $\geq 0,90$ .

**Source:** LED LUMILEDS 3528

Maintenance of minimum luminous flux to 80% - 80.000h (L80B20).

Color temperature: 4000K. Other color temperatures on demand (3000K - 5000K - Delivery time: 60 days).

**On demand:** with microwave motion detector with crepuscular

**Standard references**

EN60598-1; EN60598-2-1; EN62471

EN62031; EN60598-2-5; EN61547

La certificazione fotometrica dei nostri apparecchi viene sempre effettuata da un istituto esterno. Efficienza luminosa e "lm Output" sono quindi il risultato di tale istituto.

*The photometric certification of our appliances is always carried out by an external institute. Luminous efficiency and "lm Output" are therefore the result of this institute.*

220-240 Vac	50/60 Hz	IP66	IK09	CRI > 80	+50 C° -20	CE	17 pending			850°	TECEE
RG0	LOW FLICKER	Driver included  MULTIPOWER		Driver included  RIPPLE FREE							

Luce solo all'occorrenza per un ulteriore risparmio di energia  
*Light only when needed for further energy saving*

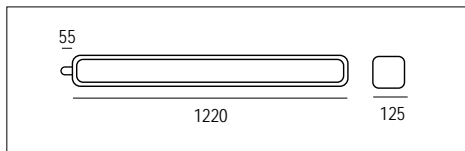
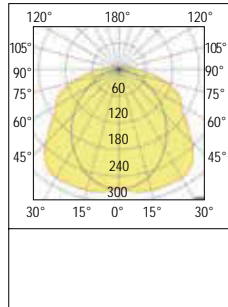

	colour	W	Optic	K	lm output	lm/W	pcs	Kg	CELL
	G	22	110°	4000	3.600	165	1	4,40	32000/F/PUPI
	G	36	110°	4000	6.000	165	1	4,40	32001/F/PUPI
	G	45	110°	4000	7.400	165	1	4,40	32030/FPUPI

**A richiesta: LED Pupilla versione EMERGENZA (aggiungere EM dopo il codice)**  
**On demand: LED Pupilla EMERGENCY version (add EM after the code)**

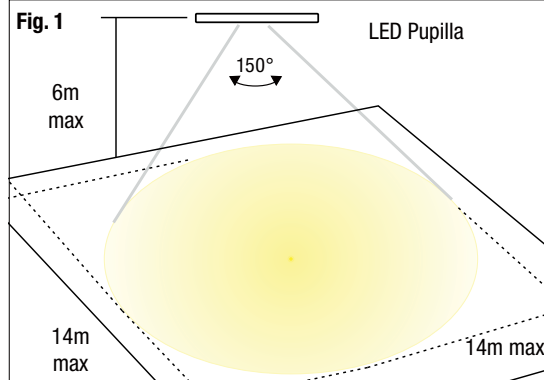
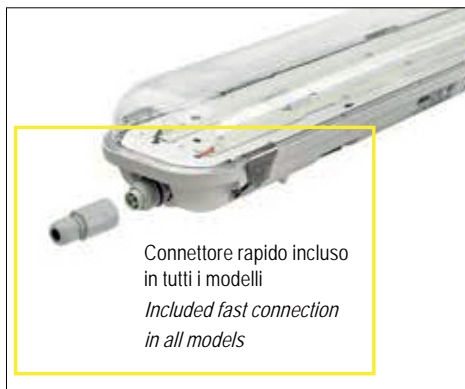

**Funzioni del sensore nell'area di rilevamento (Fig. 1):**

- A - Rileva un movimento e la luce si accende
- B - Se non rileva alcun movimento, a seconda del livello di luminosità rilevato nell'ambiente la luce dopo un certo tempo verrà regolata secondo la programmazione preimpostata oppure si spegnerà dopo un tempo prestabilito

**Sensor functions in the detection area (Fig. 1):**

- A - If it detects movement, the light turns on
- B - If it does not detect any movement, depending on the brightness level detected in the environment the light will be adjusted after a certain time according to the preset schedule or it will turn off after a set time

Esempio di funzionamento 2 livelli di luminosità - Operation example 2 brightness levels

Quando non viene rilevato alcun movimento la luce rimane accesa a livello preimpostato (10%, 20%, 30% o 50% di luminosità) <i>When no motion is detected the light stays on at a preset level (10%, 20%, 30% or 50% of brightness)</i>	Quando viene rilevato un movimento il sensore accenderà la luce al 100% di luminosità <i>When motion is detected the sensor will turn on the light to 100% brightness</i>	La luce rimarrà accesa al 100% per il tempo di mantenimento preimpostato (5sec, 30sec, 1min, 5min, 10min, 20min e 30min). <i>The light will stay on at 100% for the preset holding time (5sec, 30sec, 1min, 5min, 10min, 20min and 30min).</i>	Quando non viene rilevato alcun movimento e trascorso il tempo di attesa, il sensore dimmerà la luce al livello di luminosità preimpostato (10%, 20%, 30% o 50% di luminosità) <i>When no motion is detected and the waiting time has elapsed, the sensor dims the light to the preset brightness level (10%, 20%, 30% or 50% of brightness)</i>

Quando non viene rilevato alcun movimento la luce rimane spenta <i>When no motion is detected the light stayed off</i>	Quando viene rilevato un movimento il sensore accenderà la luce al 100% di luminosità <i>When motion is detected the sensor will turn on the light to 100% brightness</i>	La luce rimarrà accesa al 100% per il tempo di mantenimento preimpostato (5sec, 30sec, 3min, 5min, 10min, 20min e 30min). <i>The light will stay on at 100% for the preset holding time (5sec, 30sec, 3min, 5min, 10min, 20min and 30min).</i>	Quando non viene rilevato alcun movimento e trascorso il tempo di attesa, il sensore dimmerà la luce al livello di luminosità preimpostato (10%, 20%, 30% o 50% di luminosità) <i>When no motion is detected and the waiting time has elapsed, the sensor dims the light to the preset brightness level (10%, 20%, 30% or 50% of brightness)</i>	Dopo 10min il sensore spegnerà la luce <i>After 10min the sensor will turn off the light</i>	

Waterproof luminaires

# LED Allegra ATEX 2-22



Waterproof luminaires

A richiesta - *On demand*

1-10Vdc

Sensor

**DALI 2**

Vedi Pag. VI - See page VI

Apparecchio di illuminazione adatto all'ambiente con pericolo di esplosione di gas, polvere e fumi di combustibili. LED Allegra ATEX è conforme ai requisiti richiesti dal decreto governativo 116/2016 Coll. e la Direttiva della Comunità Europea n. 2014/34 / UE

**Installazione:** a soffitto o a sospensione

**Corpo:** in policarbonato Grigio (PC) = alta resistenza meccanica

**Ganci:** acciaio inossidabile + poliammide + 15% fibra di vetro

**Diffusore:** in policarbonato traslucido (PC) = alta resistenza meccanica

**PG:** pressacavo in metallo M20x1,5 ATEX PA66 (cavo Ø 6-12mm<sup>2</sup>)

**Riflettore:** lamiera di acciaio. Colore bianco (RAL9003)

**Driver:** incluso nel sistema > 50.000 h

Fattore di potenza ≥0,95.

**Sorgente:** LED. Mantenimento del flusso luminoso minimo al 80% - 80.000h (L80B20) per il 90% dei LED.

Temperatura di colore: 4000K

*The light fitting is suitable for the environment with a danger of explosion of gas, dust and combustibles fumes. The light fittings meet the requirements of Government Decree 116/2016 Coll. and European Community Directive No.2014/34/EU*

**Installation:** ceiling or suspended

**Body:** grey polycarbonate (PC) = high mechanical resistance

**Hooks and screws:** in stainless steel

**Clips:** stainless steel + polyamide + 15% glass fibre

**Diffuser:** translucent polycarbonate (PC) = high mechanical resistance

**Metal cable glands:** screwed M20x1,5 (cable Ø 6-12mm<sup>2</sup>)

**Reflector:** steel sheet. White colour (RAL9003)

**Driver:** included included in the system > 50.000 h. Power factor ≥0,95.

**Source:** LED. Maintenance of minimum luminous flux to 80% - 80.000h (L80B20) for 90% of LED.

**Color temperature:** 4000K.

(1) **Statement of Conformity**

(2) Equipment and protective systems intended for use in potentially explosive atmospheres. Directive 2014/34/EU

(3) **Statement of Conformity Number:** TÜV CY 20 ATEX 0206330

(4) **for the equipment:** LED luminaires  
Type: LED ALLEGRA ATEX 2-22 \*\*\*\*\*/\*\*\*\*\*

(5) **of the manufacturer:** Relco S.r.l.

(6) **Address:** Via delle Azalee, 8/A  
20090 Buccinasco - Milano - Italy

Order number: 0206330  
Date of issue: 2020-06-12

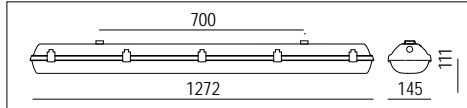
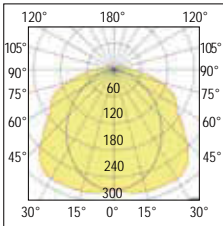
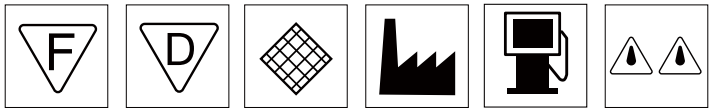
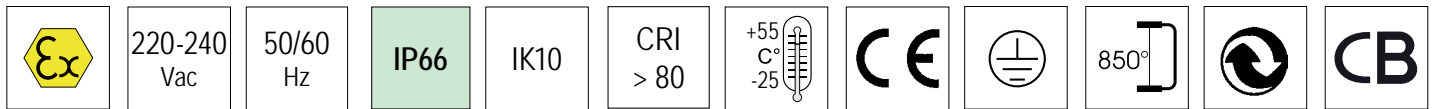

**110°**  
Diffondente - Wide



colour	W	Optic	K	lm output	lm/W	pcs	Kg	CELL
G	35 - 42 - 50	110°	4000	Vedi tabella See table	156	1	3,40	32030/AXT

colour	W	Optic	K	lm output	lm/W	pcs	Kg	CELL-E
G	35	110°	4000	Vedi tabella See table	156	1	3,20	32001/AXTEM
G	42	110°	4000		156	1	3,40	32030/AXTEM
G	50	110°	4000		156	1	3,50	32031/AXTEM

**AUTOESTINGUENZA:** LED Allegra Atex è realizzata in un materiale plastico in classe V2. Con questo materiale il corpo lampada si spegnerà entro 25".

**FILO INCANDESCENTE:** LED Allegra Atex è resistente alla prova del filo incandescente per 850°C.

**SELF-EXTINGUISHING:** LED Allegra Atex is made of a plastic material in class V2. With this material the specimen will turn off within 25".

**INCANDESCENT WIRE:** LED Allegra Atex is resistant to the glow wire test for 850 ° C.

Protezione da atmosfere esplosive <i>Protection against explosive atmospheres</i>	CE Ex II 3G Ex nR IIC T6 Gc CE Ex II 3D Ex tc IIIC T80° C Dc
Zona pericolosa ammessa - <i>Hazardous area allowed</i>	Zona 2 - Zone 2 / Zona 22 - Zone 22
Normative di riferimento - <i>Standard references</i>	EN60079-0 / EN60079-15 / EN60079-31

**Accessori inclusi - Included accessories**

**Flusso/potenza regolabili manualmente - Flux / power manually adjustable**



Per una corretta gestione dell'impianto di illuminazione, bisogna sempre tenere conto sia della necessità di illuminamento realizzato tramite calcolo illuminotecnico, che il rispetto dei consumi energetici. I nostri modelli LED Gioia permettono di ottenere questo risultato poiché sono dotati di Driver multipower; questi particolari Driver consentono di impostare la corrente in uscita tramite dip-switch, fornendo, di conseguenza, la corretta potenza di lampada in base all'esigenza desiderata, permettendo quindi sia il risparmio energetico che il rispetto del flusso luminoso determinato in fase di progetto.



*For proper management of the lighting system, it is always necessary to take into account both the need for lighting achieved through lighting engineering calculations, and respect for energy consumption. Our LED Gioia models allow to obtain this result as they are equipped with multipower Driver; these particular drivers allow you to set the output current via dip-switches, thus providing the correct lamp power based on the desired need, thus allowing both energy savings and respect for the luminous flux determined in the design phase.*

LED Driver multipotenza incluso LED Driver multipower included		
I mA	W	Lm output
350	35	5.460
420	42	6.550
500	50	7.800
Taratura di fabbrica Factory setting		



Dip switch per la selezione della corrente in uscita  
*Equipped with dip switch for selection the output current*

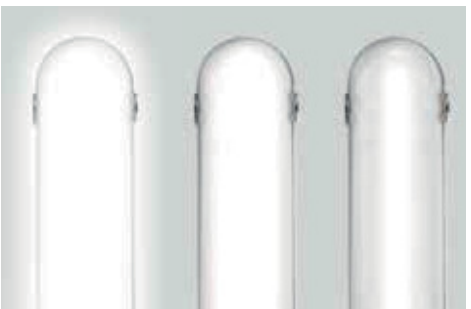

Staffa di fissaggio a parete/plafone in acciaio inox. Tasselli e viti non compresi. Per l'installazione a parete o soffitto utilizzare tasselli e viti adeguati alla superficie su cui andrà ancorata - *Wall/ceiling fixing bracket made by stainless steel. Plug and screws are not included. For ceiling or wall installation use plug and screws adapted to surface upon which it will be anchored.*

Possibilità di collegamento passante in fila continua (accessori inclusi).  
*Possibility of through connection in continuous line (accessories included).*



Morsetteria 5 poli per ripartizione su linea trifase.  
*5-pole terminal block for distribution on three-phase line.*

Waterproof luminaires

# LED Allegra Metal Predisposta per cablaggio in fila continua - Prepared for loop in - loop out



Apparecchio stagno di illuminazione a LED per applicazioni a luce diffusa da interno e da esterno.  
Adatto all'illuminazione di stabilimenti di produzione, magazzini, depositi.

**Installazione:** a soffitto o a sospensione

**Corpo:** corpo in acciaio stampato in un unico pezzo di elevata resistenza meccanica

**Ganci:** in acciaio inossidabile AISI 304

**Diffusore:** in policarbonato opale autoestinguente V2 stabilizzato ai raggi UV.

**Driver:** multipotenza incluso > 50.000 h

Fattore di potenza ≥ 0,95.

**Sorgente:** LED. Mantenimento del flusso luminoso minimo al 80.000h (L80B20) per il 90% dei LED.

**Norme di riferimento**

EN60598-1; EN60598-2-1; EN62471; EN61547

**Classificazione rischio fotobiologico:** gruppo esente

**A richiesta:** 3000K o 6000K con sovrapprezzo di 30,00 Euro  
Direttiva HACCP per gli impianti illuminotecnici nelle industrie alimentari

*LED waterproof luminaire for diffused indoor and outdoor light applications.*

*Suitable for lighting production facilities, warehouses, warehouses, pavilions, workshop areas and large areas in general.*

**Installation:** ceiling or suspended

**Body:** body in pressed steel in a single piece of high mechanical resistance

**Clips:** in AISI 304 stainless-steel

**Diffuser:** in self-extinguishing opal polycarbonate V2 UV stabilised

**Driver:** multipower cluded > 50.000 h

Power factor ≥ 0,95.

**Source:** LED **LG** Maintenance of minimum luminous flux to 80% - 80.000h (L80B20) for 90% of LED.

**Standard references**

EN60598-1; EN60598-2-1; EN62471; EN61547

**Photobiological risk classification:** no risk

**Upon request:** 3000K or 6000K with a 30.00 Euro extra charge  
HACCP directive for lighting systems in food industries

Waterproof luminaires

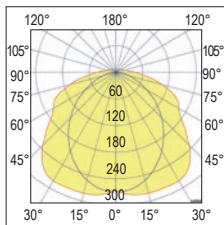

220-240 Vac	50/60 Hz	IP65	IK06	IK09	A richiesta On demand
----------------	-------------	------	------	------	--------------------------

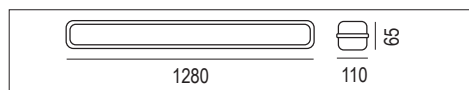

**110°**  
Diffondente - Wide

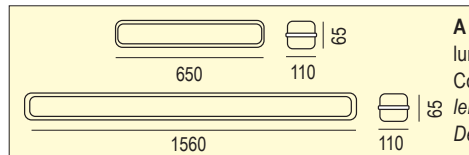

**A richiesta/On request:**  
lunghezza 650mm o 1560mm.  
Consegna 90 giorni.  
length 650mm or 1560mm  
Delivery 90 days.



LED Driver multipotenza incluso LED Driver multipower included				
PIN 1	PIN 2	I mA	W	Lumen output
OFF	OFF	900	48*	5.800
OFF	ON	1.050	56	7.200
ON	OFF	1.100	60	7.730
ON	ON	1.200	65	8.500
Settaggio di fabbrica - Factory setting				

colour	W	Optic	K	lm output	lm/W	pcs	Kg	CELL
A	45* - 56 - 65	120°	4000	See Table	130	1	6,60	32031/60/MET

colour	W	Optic	K	lm output	lm/W	pcs	Kg	CELL	
A	45* - 56 - 65	120°	4000	See Table	130	1	6,60	32031/60/MDAL	

colour	W	Optic	K	lm output	pcs	Kg	CELL-E		
A	45* - 56 - 65	120°	4000	See Table	1	6,60	32031METEM		



Dip switch per la selezione della corrente in uscita  
Equipped with dip switch for selection the output current

colour	W	Optic	K	lm output	pcs	Kg	CELL-E		
A	45* - 56 - 65	120°	4000	See Table	1	6,60	3203160MDALEM		

# LED Allegra Metal

Accessori NON inclusi - *NOT included accessories*



Cod. 000151  
Kit 2 ganci sicurezza anticaduta - *Kit of 2 safety hooks against fall*



Accessori inclusi - *Included accessories*

Kit per montaggio a plafone  
*Ceiling mounting kit*



Possibilità di collegamento passante in fila continua (accessori inclusi).

*Possibility of through connection in continuous line (accessories included).*

**N° massimo di apparecchi collegabili per ogni linea elettrica**  
**Maximum number of devices that can be connected to any electrical line**

W Puissance - Leistung	N° maximum d'appareils Max. Anzahl der Geräte
45	26
56	30
65	20

A richiesta - *On demand*



**Emergency**

Con cablaggio in emergenza ad alimentazione centralizzata. Apparecchio permanente, con alimentatore funzionante AC/DC, alimentato da un sistema di emergenza centralizzato, cioè non incorporato nell'apparecchio

*With centralized emergency wiring. Permanent device, with AC / DC power supply, powered by a centralized emergency system, i.e. not incorporated into the device*



# LED Lanterna

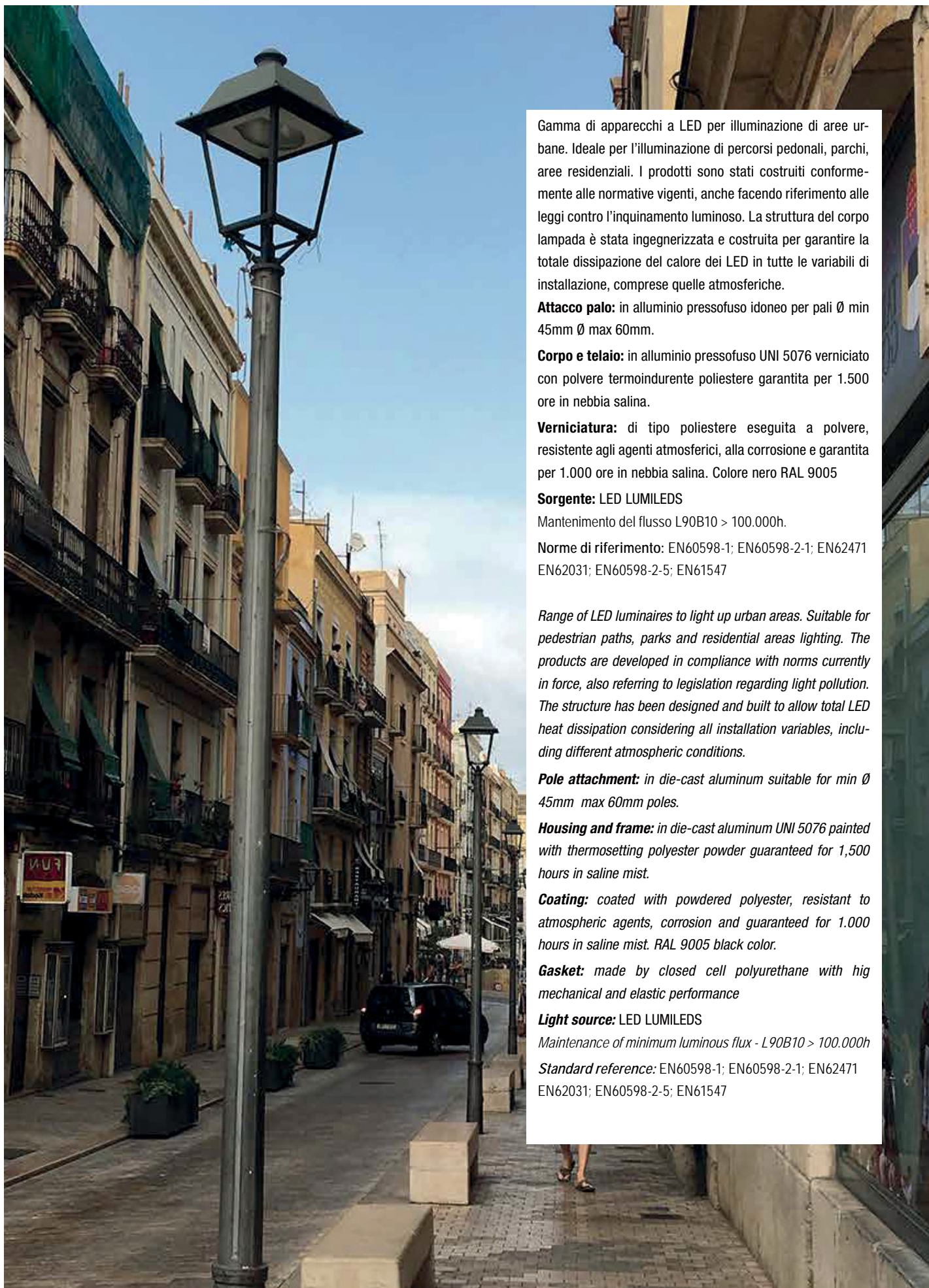

Gamma di apparecchi a LED per illuminazione di aree urbane. Ideale per l'illuminazione di percorsi pedonali, parchi, aree residenziali. I prodotti sono stati costruiti conformemente alle normative vigenti, anche facendo riferimento alle leggi contro l'inquinamento luminoso. La struttura del corpo lampada è stata ingegnerizzata e costruita per garantire la totale dissipazione del calore dei LED in tutte le variabili di installazione, comprese quelle atmosferiche.

**Attacco palo:** in alluminio pressofuso idoneo per pali  $\varnothing$  min 45mm  $\varnothing$  max 60mm.

**Corpo e telaio:** in alluminio pressofuso UNI 5076 verniciato con polvere termoindurente poliestere garantita per 1.500 ore in nebbia salina.

**Verniciatura:** di tipo poliestere eseguita a polvere, resistente agli agenti atmosferici, alla corrosione e garantita per 1.000 ore in nebbia salina. Colore nero RAL 9005

**Sorgente:** LED LUMILEDS

Mantenimento del flusso L90B10 > 100.000h.

**Norme di riferimento:** EN60598-1; EN60598-2-1; EN62471 EN62031; EN60598-2-5; EN61547

*Range of LED luminaires to light up urban areas. Suitable for pedestrian paths, parks and residential areas lighting. The products are developed in compliance with norms currently in force, also referring to legislation regarding light pollution. The structure has been designed and built to allow total LED heat dissipation considering all installation variables, including different atmospheric conditions.*

**Pole attachment:** in die-cast aluminum suitable for min  $\varnothing$  45mm max 60mm poles.

**Housing and frame:** in die-cast aluminum UNI 5076 painted with thermosetting polyester powder guaranteed for 1,500 hours in saline mist.

**Coating:** coated with powdered polyester, resistant to atmospheric agents, corrosion and guaranteed for 1.000 hours in saline mist. RAL 9005 black color.

**Gasket:** made by closed cell polyurethane with high mechanical and elastic performance

**Light source:** LED LUMILEDS

Maintenance of minimum luminous flux - L90B10 > 100.000h

**Standard reference:** EN60598-1; EN60598-2-1; EN62471 EN62031; EN60598-2-5; EN61547

100-240  
Vac

50/60  
Hz

IP66

IK08

CRI  
> 70



850°



Driver included

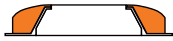

RG0



LOW  
FLICKER



420x420

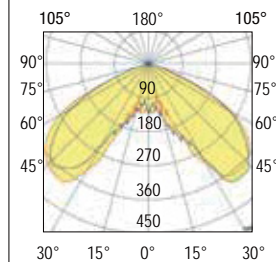
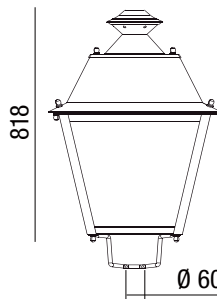

Ottica STANDARD per illuminazione parchi - STANDARD optics recommended for lighting in parks LT-20485

colour	W	Optic	K	lm output	lm/W	pcs	Kg	CELL
<b>N</b>	24	ST	2200	3.200	130	1	8,20	LANT2422K
<b>N</b>	24	ST	3000	3.250	135	1	8,20	LANT243K
<b>N</b>	24	ST	4000	3.480	145	1	8,20	LANT244K
<b>N</b>	56	ST	2200	7.280	130	1	8,20	LANT5622K
<b>N</b>	56	ST	3000	7.560	135	1	8,20	LANT563K
<b>N</b>	56	ST	4000	8.120	145	1	8,20	LANT564K
<b>N</b>	75	ST	2200	9.750	130	1	8,20	LANT7522K
<b>N</b>	75	ST	3000	10.100	135	1	8,20	LANT753K
<b>N</b>	75	ST	4000	10.900	145	1	8,20	LANT754K



Street furniture

Esempi applicativi - Application example



**A richiesta (richiedere codice prodotto agli uffici commerciali)**  
**On demand (request code product to commercial offices)**  
 Staffa superiore per applicazione a parete  
*Upper bracket for wall application*



**A richiesta (richiedere codice prodotto agli uffici commerciali)**  
**On demand (request code product to commercial offices)**  
 Staffa inferiore per applicazione a parete  
*Lower bracket for wall application*



**A richiesta (richiedere codice prodotto agli uffici commerciali)**  
**On demand (request code product to commercial offices)**  
 Diffusore in vetro  
*Glass diffusor*

Cod. VETTRASFORO  
 Con foro per Lanterna con alimentazione dal basso  
*With hole for Lanterna with power supply from below*



Cod. VETTRASNOFORO  
 Senza foro per Lanterna con alimentazione dall'alto  
*Without hole for Lanterna with power supply from above*



NON inclusa  
 NOT included

Incluso  
 Included

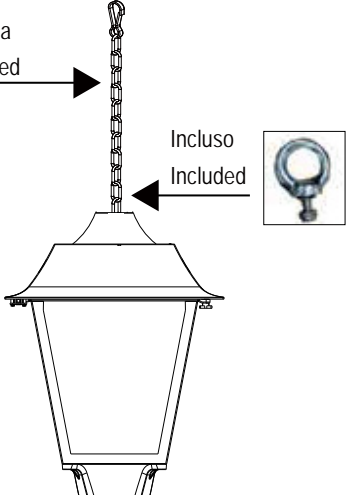

**A richiesta (richiedere codice prodotto agli uffici commerciali)**  
**On demand (request code product to commercial offices)**  
 Catena per applicazione a sospensione  
*Chain for suspension application*

**Settaggio del flusso luminoso: avviene tramite programmazione della corrente di pilotaggio da richiedere in sede in fase d'ordine / progetto**  
**Luminous flux setting: takes place by programming the driving current to be requested at the time of the order / project**

DYNA CONTROL è un sistema automatico di controllo del flusso luminoso delle lampade. Il sistema entra in funzione alla prima accensione calcolando per 3 giorni i tempi di accensione, il quarto giorno il sistema in modo autonomo, calcola la mezzanotte virtuale eseguendo una regolazione del flusso regolando la lampada come indicato sullo schema di Fig. 1; per i primi tre giorni, quindi, il sistema manterrà le lampade accese al 100%, nel tempo di accensione dell'impianto, il quarto giorno entrerà in funzione il sistema DYNA CONTROL gestendo in modo autonomo il flusso luminoso garantendo così un notevole risparmio energetico.

Accensioni inferiori ad 1 ora (es. manutenzione) verranno ignorate ed il sistema non entra in funzione, per accensioni da 1 a 4 ore (es. anomalia impianto) o superiori alle 23 ore (es. impianto sempre acceso), il sistema resetta il timer quindi ricomincerà a contare per i primi 3 giorni e successivamente riprenderà il funzionamento automatico.

*DYNA CONTROL is an automatic control system for the luminous flux of the lamps. The system comes into operation at the first start-up by calculating the ignition times for 3 days, on the fourth day the system autonomously calculates the virtual midnight by adjusting the flow by adjusting the lamp as indicated in the diagram in Fig. 1; for the first three days, therefore, the system will keep the lamps on at 100%, during the system start-up time, on the fourth day the DYNA CONTROL system will come into operation, independently managing the luminous flux thus ensuring significant energy savings.*

*Switch-ons of less than 1 hour (e.g. maintenance) will be ignored and the system does not start up, for switch-ons from 1 to 4 hours (e.g. system anomaly) or longer than 23 hours (e.g. system always on), the system resets the timer will then start counting again for the first 3 days and will then resume automatic operation.*

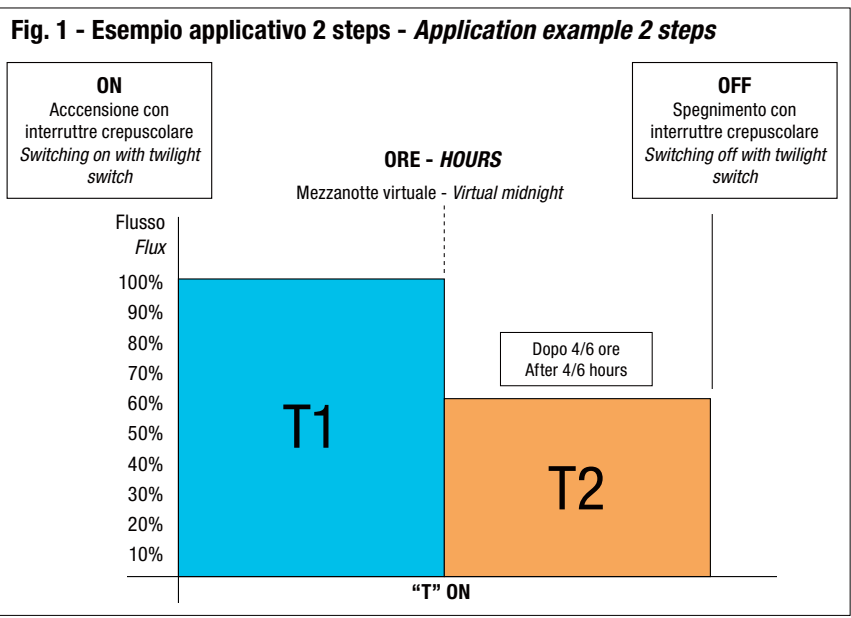

# LED Lanterna NEW

## UPGRADE LED LANTERNE



La soluzione di relamping LED permette:

- Riduzione dei costi di intervento e manutenzione.
- Facilità di installazione senza modifiche strutturali

The LED relamping solution allows:

- Cost reduction of intervention and maintenance.
- Easy installation without structural modifications



VECCHIO - OLD



260x190x75mm



275x200x80mm

NUOVO - NEW



**Materiale:** alluminio di elevata purezza  
**Diffusore:** vetro trasparente  
**Finitura:** silver  
**Potenza:** 20÷80W - 100 Lm/W  
**Ottiche:** 4 modelli in PMMA  
**Temperatura di colore:** 2.2K - 2.7K - 3K  
**LED:** CREE 3535  
**Prezzo:** On demand

**Structure material:** high purity aluminium  
**Diffuser material:** transparent glass  
**Structure finish:** silver  
**Power:** 20÷80W - 100 Lm/W  
**Optical:** 4 models PMMA  
**Color temperature:** 2.2K - 2.7K - 3K  
**LED:** CREE 3535  
**Price:** On demand

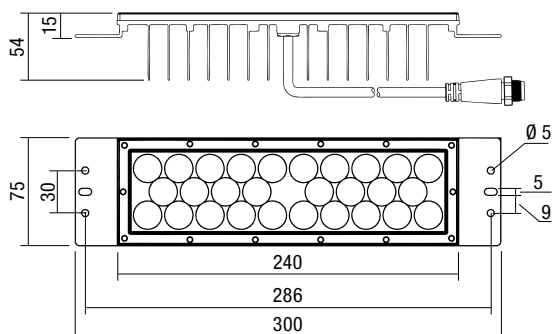

Corrente nominale (Max) - Rated current (Max)	720 mA	930 mA	1140 mA	1330 mA
Tensione massima - Max forward voltage	42V	42V	44V	45V
Potenza massima - Max power	30W	40W	50W	60W
Flusso luminoso - Luminous flux	5700 Lm	7200 Lm	8500 Lm	9600 Lm
Efficienza - Efficiency	190 Lm/W	180 Lm/W	170 Lm/W	160 Lm/W

LED 5050 - Colorazione 3K - 4  
 L90B10 > 100.000h.

LED 5050 - Coloring 3K - 4  
 L90B10 > 100.000h.

# LED Lampione 2 - 4 - 6 - 7 - 8 - 9 - 10 - 12



Gamma di apparecchi a LED per illuminazione di aree urbane. Ideale per l'illuminazione di percorsi pedonali, parchi, aree residenziali. I prodotti sono stati costruiti conformemente alle normative vigenti, anche facendo riferimento alle leggi contro l'inquinamento luminoso.

**Attacco palo:** in alluminio pressofuso idoneo per pali Ø min 45mm Ø max 60mm.

**Corpo e bracci:** in alluminio pressofuso UNI 5076 verniciato con polvere termoindurente poliestere garantita per 1.500 ore in nebbia salina.

**Ottiche:** in PMMA con resistenza alle alte temperature e ai raggi UV.

**Verniciatura LED Lampione 2:** di tipo poliestere eseguita a polvere, resistente agli agenti atmosferici, alla corrosione e garantita per 1.500 ore in nebbia salina. Colore Nero RAL 9005

**Verniciatura LED Lampione 4 / 6 / 7 / 8 / 9 / 10 / 12:** il ciclo di verniciatura standard a liquido, ad immersione, è composto da diverse fasi.

Una prima fase di pretrattamento superficiale del metallo, poi una verniciatura in cataforesi episodica resistente alla corrosione e alle nebbie saline, poi una mano finale di liquido bicomponente acrilico, stabilizzato ai raggi UV. Per ambienti marini (fronte mare) conforme alla Norma UNI EN ISO 9227 (circa 1.000 ore)

- Grigio RAL 9007 (a richiesta RAL 9005)

**Schermo:** vetro temperato di spessore 4mm resistente agli shock termici (Lampione 2). In policarbonato spessore 2,5mm resistente agli shock termici e agli urti (Lampione 4). Vetro temperato di spessore 4mm colore nero resistente agli shock termici (Lampione 6 - 7 - 8 - 9 - 10 - 12).

**Sorgente:** LED **SAMSUNG** - LUMILEDS

Mantenimento del flusso L90B10 > 100.000h.

**Temperatura di colore:** 2200K, 3000K e 4000K.

CRI >70

**Driver:** incorporato . Fattore di potenza ≥0,98.

**A richiesta:** Il settaggio del flusso luminoso può essere modificato tramite programmazione della corrente di pilotaggio da richiedere in sede in fase d'ordine.

Protezione alle sovratensioni secondo le normative vigenti.

A richiesta modo differenziale 6kV (L-N)

modo comune 8kV (L-GND, N-GND, L & N-GND)

Norme di riferimento:

IEC 61000-4-5; EN60598-1; EN60598-2-1; EN62471; EN62031; EN60598-2-5; EN61547

*Range of LED luminaires for urban lighting. Ideal for lighting pedestrian walkways, parks, residential areas. The products have been built in accordance with current regulations, also referring to the laws against light pollution.*

**Pole attachment:** in die-cast aluminum suitable for min Ø 45mm max 60mm poles.

**Body and arms:** in die-cast aluminum UNI 5076 painted with thermosetting polyester powder guaranteed for 1,500 hours in saline mist.

**Optics:** in PMMA with resistance to high temperatures and UV rays.

**Painting LED Lampione 2:** polyester powder type, resistant to atmospheric agents, corrosion and guaranteed for 1,500 hours in saline mist.

- Black color RAL 9005

**Painting LED Lampione 4 / 6 / 7 / 8 / 9 / 10 / 12:** the standard liquid painting cycle, by immersion, is made up of different phases.

A first phase of surface pre-treatment of the metal, then an episodic cathodoresis painting resistant to corrosion and salt spray, then a final coat of two-component acrylic liquid, stabilized against UV rays. For marine environments (seafront) compliant with the UNI EN ISO 9227 standard (approximately 1,000 hours)

- Grey RAL 9007 (on demand RAL 9005)

**Screen:** 4mm thick tempered glass resistant to thermal shock (Lamp post 2). In polycarbonate 2,5 mm thick, resistant to thermal shocks and impacts (Lamp 4). 4mm thick black tempered glass resistant to thermal shock (Lamp 6 - 7 - 8 - 9 - 10 - 12).

**Source:** LED **SAMSUNG** - LUMINLEDS

Maintenance of minimum luminous flux - L90B10 > 100.000h.

**Color temperature:** 2200K, 3000K and 4000K. CRI >70

**Driver:** built-in. Power factor ≥0.98.

**On request:** The setting of the luminous flux can be changed by programming the driving current to be requested when ordering.

**Overvoltage protection according to current regulations.**

On request 6kV differential mode (L-N)

Common mode 8kV (L-GND, N-GND, L & N-GND)

**Reference standards:**

IEC 61000-4-5; EN60598-1; EN60598-2-1; EN62471; EN62031; EN60598-2-5; EN61547

# LED Lampione 2 - 4 - 6 - 7 - 8 - 9 - 10 - 12



Street furniture

A richiesta - On demand

1-10Vdc



Wireless



Vedi Pag. VI - See page VI

DYNA

## LED Lampione 2 - 4



LED Lampione 2



LED Lampione 4

Apparecchio predisposto  
all'installazione su palo  
(Vedi Pag. 100)  
Device designed for pole  
installation (See page 100)

## LED Lampione 2



A richiesta: 2200K  
On demand: 2200K

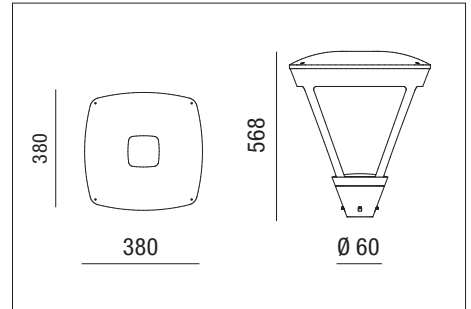
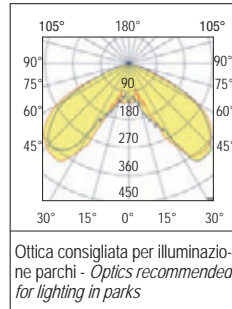
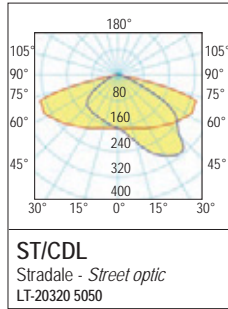

220-240 Vac

110 Vac a richiesta on demand

50/60 Hz

IP66

IK08

+50 C° -20

0,37 m²

850°

CRI >70



**DRIVER INCLUDED**



RG0



LOW FLICKER



colour	W	Optic	K	lm output	lm/W	pcs	Kg	CELL
N	24	ST	3000	2.880	120	1	9,00	31510/3KS
N	24	ST	4000	2.880	120	1	9,00	31510S
N	40	ST	3000	4.800	120	1	9,00	31512/3KS40
N	56	ST	3000	6.720	120	1	9,00	31512/3KS
N	56	ST	2200	6.720	120	1	9,00	31512/2KS
N	56	ST	2700	6.720	120	1	9,00	31512/27KS
N	56	ST	4000	6.720	120	1	9,00	31512S
N	75	ST	3000	9.000	120	1	9,00	31513/3KS
N	75	ST	4000	9.000	120	1	9,00	31513S

## LED Lampione 4



A richiesta: 2200K  
On demand: 2200K

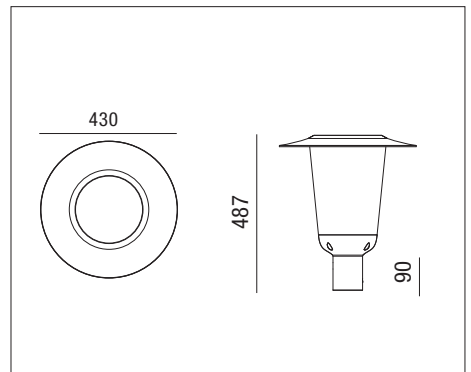
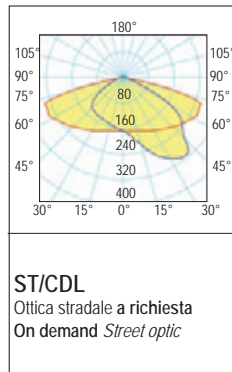
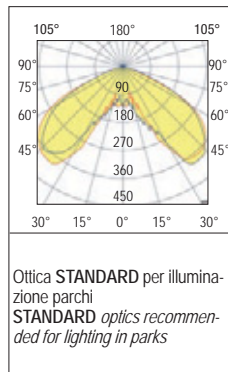

220-240 Vac

110 Vac a richiesta on demand

50/60 Hz

IP66

IK08

+50 C° -20

0,37 m²

850°

CRI >70



**DRIVER INCLUDED**



RG0



LOW FLICKER



colour	W	Optic	K	lm output	lm/W	pcs	Kg	CELL
G	24	PK	3000	2.880	120	1	9,00	32510/3KS
G	24	PK	2200	2.880	120	1	9,00	32510/2KS
G	24	PK	4000	2.880	120	1	9,00	32510S
G	56	PK	3000	6.720	120	1	9,00	32512/3KS
G	56	PK	2200	6.720	120	1	9,00	32512/2KS
G	56	PK	4000	6.720	120	1	9,00	32512S
G	75	PK	3000	9.000	120	1	9,00	32513/3KS
G	75	PK	4000	9.000	120	1	9,00	32513S



Tutti gli apparecchi di illuminazione di questo catalogo utilizzano un Driver LED "MULTIPOWER". A richiesta, per quantità, è possibile cambiare in fabbrica la taratura della corrente e, di conseguenza, potenza (W) e Lumen (Lm)

All the luminaires in this catalog use a "MULTIPOWER" LED Driver.  
On request, for quantity, it is possible to change the current calibration in the factory and, consequently, power (W) and Lumen (Lm)

## LED Lampione 6 - 7



Apparecchio predisposto all'installazione su palo (Vedi Pag. 100)  
Device designed for pole installation  
(See page 100)

# LED Lampione 6



A richiesta  
Nero RAL 9005.  
Aggiungere BL dopo il codice  
On demand  
Black RAL 9005.  
Add BL after the code

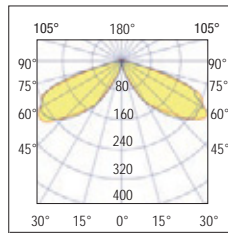

Ottica STANDARD per illuminazione parchi  
STANDARD optics recommended for lighting in parks

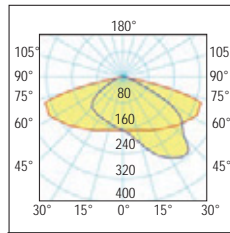

ST/CDL  
Ottica stradale a richiesta  
On demand Street optic

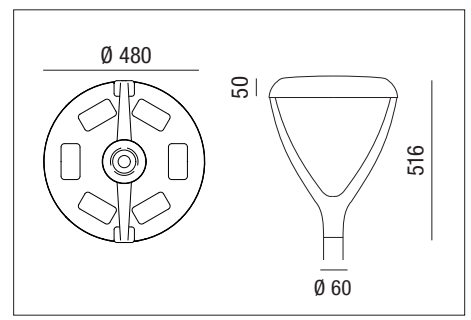

220-240 Vac 110 Vac a richiesta on demand

50/60 Hz IP66 IK08

+50°C -20°C 0,14 m<sup>2</sup> 850°

CRI >70 CE

DRIVER INCLUDED

RG0

LOW FLICKER

03

colour	W	Optic	K	nominal Im tc = 25°C	Im output	lm/W	pcs	Kg	CELL
G	24	PK	3000	3.250	2.880	120	1	9,00	LAMP6ST243K
G	24	PK	4000	3.250	2.880	120	1	9,00	LAMP6ST244K
G	56	PK	3000	7.600	6.720	120	1	9,00	LAMP6ST563K
G	56	PK	4000	7.600	6.720	120	1	9,00	LAMP6ST564K
G	75	PK	2200	10.200	9.000	120	1	9,00	LAMP6ST752K
G	75	PK	3000	10.200	9.000	120	1	9,00	LAMP6ST753K
G	75	PK	4000	10.200	9.000	120	1	9,00	LAMP6ST754K

# LED Lampione 7



A richiesta  
Nero RAL 9005.  
Aggiungere BL dopo il codice  
On demand  
Black RAL 9005.  
Add BL after the code

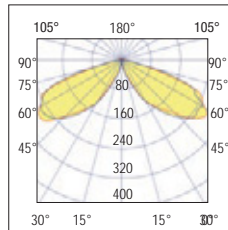

Ottica STANDARD per illuminazione parchi  
STANDARD optics recommended for lighting in parks

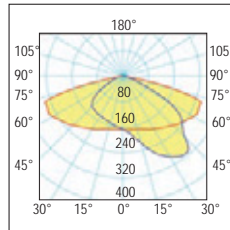

ST/CDL  
Ottica stradale a richiesta  
On demand Street optic

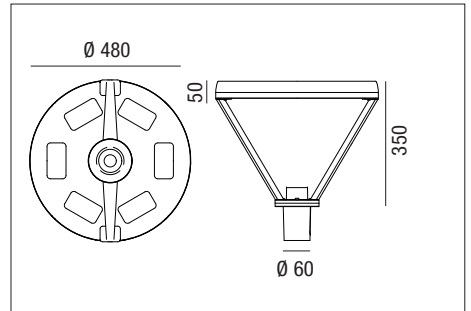

220-240 Vac 110 Vac a richiesta on demand

50/60 Hz IP66 IK08

+50°C -20°C 0,07 m<sup>2</sup> 850°

CRI >70 CE

DRIVER INCLUDED

RG0

LOW FLICKER

03

colour	W	Optic	K	nominal Im tc = 25°C	Im output	lm/W	pcs	Kg	CELL
G	24	PK	3000	3.250	2.880	120	1	9,00	LAMP7ST243K
G	24	PK	4000	3.250	2.880	120	1	9,00	LAMP7ST244K
G	56	PK	3000	7.600	6.720	120	1	9,00	LAMP7ST563K
G	56	PK	4000	7.600	6.720	120	1	9,00	LAMP7ST564K
G	75	PK	2200	10.200	9.000	120	1	9,00	LAMP7ST752K
G	75	PK	3000	10.200	9.000	120	1	9,00	LAMP7ST753K
G	75	PK	4000	10.200	9.000	120	1	9,00	LAMP7ST754K

## LED Lampione 8 - 9



# LED Lampione 8



A richiesta  
Nero RAL 9005.  
Aggiungere BL dopo il  
codice  
On demand  
Black RAL 9005.  
Add BL after the code

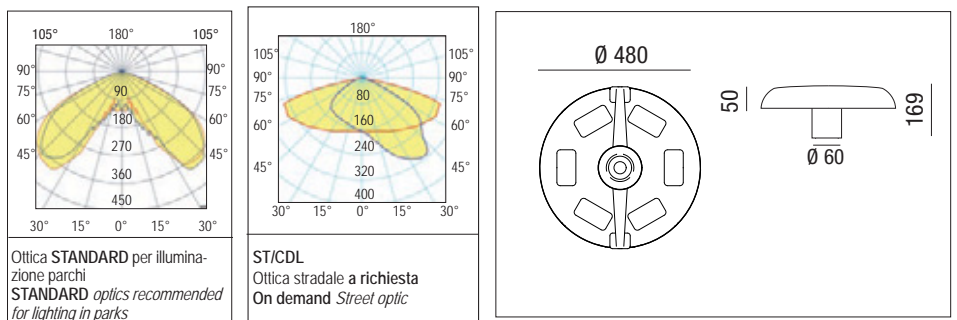

220-240 Vac
110 Vac a richiesta on demand
50/60 Hz
IP66
IK08
+50°C -20°C
0,05 m<sup>2</sup>
850°
CRI >70
CE

DRIVER INCLUDED
RG0
LOW FLICKER

colour	W	Optic	K	nominal lm tc = 25°C	lm output	lm/W	pcs	Kg	CELL
Ⓜ	24	PK	3000	3.250	2.880	120	1	9,00	LAMP8ST243K
Ⓜ	24	PK	4000	3.250	2.880	120	1	9,00	LAMP8ST244K
Ⓜ	56	PK	3000	7.600	6.720	120	1	9,00	LAMP8ST563K
Ⓜ	56	PK	4000	7.600	6.720	120	1	9,00	LAMP8ST564K
Ⓜ	75	PK	2200	10.200	9.000	120	1	9,00	LAMP8ST752K
Ⓜ	75	PK	3000	10.200	9.000	120	1	9,00	LAMP8ST753K
Ⓜ	75	PK	4000	10.200	9.000	120	1	9,00	LAMP8ST754K

# LED Lampione 9



A richiesta  
Nero RAL 9005.  
Aggiungere BL dopo il  
codice  
On demand  
Black RAL 9005.  
Add BL after the code

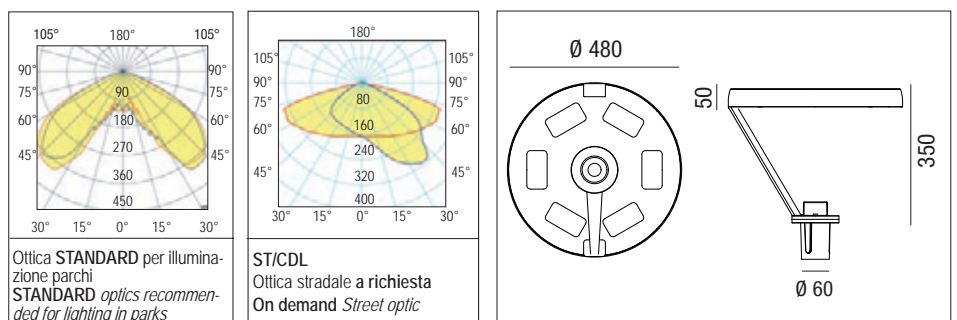

220-240 Vac
110 Vac a richiesta on demand
50/60 Hz
IP66
IK08
+50°C -20°C
0,06 m<sup>2</sup>
850°
CRI >70
CE

DRIVER INCLUDED
RG0
LOW FLICKER

colour	W	Optic	K	nominal lm tc = 25°C	lm output	lm/W	pcs	Kg	CELL
Ⓜ	24	PK	3000	3.250	2.880	120	1	9,00	LAMP9ST243K
Ⓜ	24	PK	4000	3.250	2.880	120	1	9,00	LAMP9ST244K
Ⓜ	56	PK	3000	7.600	6.720	120	1	9,00	LAMP9ST563K
Ⓜ	56	PK	4000	7.600	6.720	120	1	9,00	LAMP9ST564K
Ⓜ	75	PK	2200	10.200	9.000	120	1	9,00	LAMP9ST752K
Ⓜ	75	PK	3000	10.200	9.000	120	1	9,00	LAMP9ST753K
Ⓜ	75	PK	4000	10.200	9.000	120	1	9,00	LAMP9ST754K

## LED Lampione 10 - 12



LED Lampione 10



LED Lampione 12



Apparecchio predisposto all'installazione su palo (Vedi Pag. 100)  
Device designed for pole installation  
(See page 100)

## LED Lampione 10

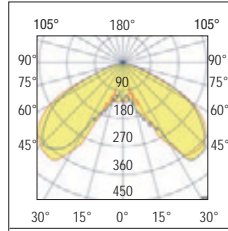

Ottica STANDARD per illuminazione parchi  
STANDARD optics recommended for lighting in parks

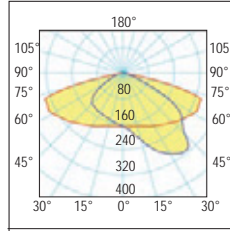

ST/CDL  
Ottica stradale a richiesta  
On demand Street optic

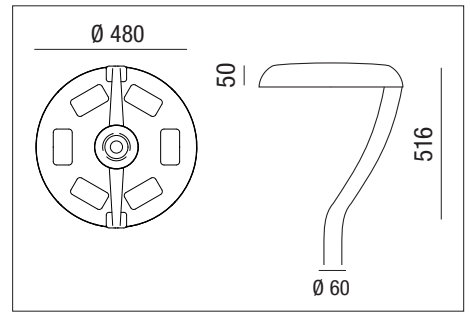

220-240 Vac

110 Vac a richiesta on demand

50/60 Hz

IP66

IK08

+50°C / -20°C

0,09 m<sup>2</sup>

850°

CRI >70



colour	W	Optic	K	nominal lm tc = 25°C	lm output	lm/W	pcs	Kg	CELL
G	24	PK	3000	3.250	2.880	120	1	9,00	LAMP10ST243K
G	24	PK	4000	3.250	2.880	120	1	9,00	LAMP10ST244K
G	56	PK	3000	7.600	6.720	120	1	9,00	LAMP10ST563K
G	56	PK	4000	7.600	6.720	120	1	9,00	LAMP10ST564K
G	75	PK	2200	10.200	9.000	120	1	9,00	LAMP10ST752K
G	75	PK	3000	10.200	9.000	120	1	9,00	LAMP10ST753K
G	75	PK	4000	10.200	9.000	120	1	9,00	LAMP10ST754K

## LED Lampione 12



A richiesta  
Nero RAL 9005.  
Aggiungere BL dopo il codice  
On demand  
Black RAL 9005.  
Add BL after the code

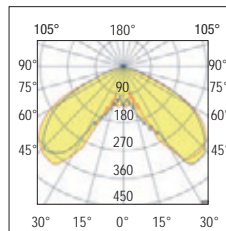

Ottica STANDARD per illuminazione parchi  
STANDARD optics recommended for lighting in parks

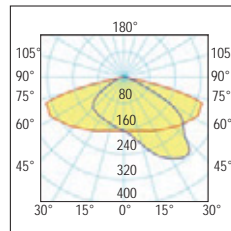

ST/CDL  
Ottica stradale a richiesta  
On demand Street optic

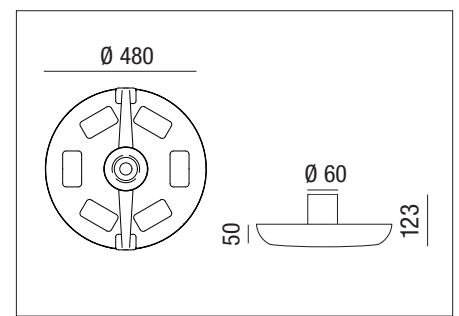

220-240 Vac

110 Vac a richiesta on demand

50/60 Hz

IP66

IK08

+50°C / -20°C

0,04 m<sup>2</sup>

850°

CRI >70



colour	W	Optic	K	nominal lm tc = 25°C	lm output	lm/W	pcs	Kg	CELL
G	24	PK	3000	3.250	2.880	120	1	9,00	LAMP12ST243K
G	24	PK	4000	3.250	2.880	120	1	9,00	LAMP12ST244K
G	56	PK	3000	7.600	6.720	120	1	9,00	LAMP12ST563K
G	56	PK	4000	7.600	6.720	120	1	9,00	LAMP12ST564K
G	75	PK	2200	10.200	9.000	120	1	9,00	LAMP12ST752K
G	75	PK	3000	10.200	9.000	120	1	9,00	LAMP12ST753K
G	75	PK	4000	10.200	9.000	120	1	9,00	LAMP12ST754K



Predisposizione Zhaga Socket  
Zhaga Socket preparation

Cod. 488787561  
Connettore max 30Vdc  
Connector max 30Vdc



Cod. 488787581  
Tappo IP66 - Cap connector IP66

A richiesta - On demand  
Sistema wireless per gestire centralmente l'illuminazione pubblica.  
Wireless system to centrally manage public lighting.

### Accessori non inclusi Not included accessories



Code: 210001465  
Adattatore palo da Ø 60mm a Ø 76mm.  
Necessario per l'installazione su palo  
Up Ø 60mm to 76mm adapter pole.  
Required for installation on the pole



Per richiedere apparecchi a LED con dispositivo della **mezzanotte virtuale** aggiungere **/ED** dopo il codice prodotto.

To order LED fixtures with a **virtual midnight** device, add **/ED** after the product code.

## Virtual Midnight (subcode/ED)

System with automatic flux reduction

Virtual midnight is a program used primarily in public lighting or wherever "smart" lighting is required. With this system, lighting fixtures tend to reduce energy consumption while maintaining safety standards by using light only when necessary, for example in areas where pedestrian or vehicle traffic is minimal during the middle of the night, returning to normal levels around dawn. The virtual midnight device uses a self-learning process to calculate and process the midpoint between the evening switch-on (sunset) and morning switch-off of the LED street lighting (dawn). The device is integrated into the LED Driver and does not require any modifications to the existing system.

## Mezzanotte virtuale (sottocodice/ED)

Sistema con riduzione automatica del flusso

La mezzanotte virtuale è una programmazione che si utilizza principalmente nell'illuminazione pubblica o laddove serve una illuminazione "intelligente" con questo sistema gli apparecchi di illuminazione tendono a ridurre i consumi mantenendo comunque gli standard di sicurezza utilizzando la luce solamente quando è necessario, per esempio in zone dove il traffico pedonale o il traffico automobilistico sono minimi nelle ore centrali della notte per poi tornare ai livelli normali verso l'alba. Il dispositivo della mezzanotte virtuale tramite un processo di auto-apprendimento calcola ed elabora il punto medio tra l'accensione serale (tramonto) e lo spegnimento dell'armatura stradale a led al mattino (alba). Il dispositivo è inserito nel LED Driver e non è necessario fare nessuna modifica nell'impianto esistente.

### DYNA

Il settaggio del **FLUSSO LUMINOSO** avviene con programmazione della corrente di pilotaggio. Tale programmazione va richiesta in sede, durante la fase d'ordine / progetto.

The **LUMINOUS FLUX** setting is done by programming the driving current. This programming must be requested on site, during the order / project phase

DYNA CONTROL è un sistema automatico di controllo del flusso luminoso delle lampade. Il sistema entra in funzione alla prima accensione calcolando per 3 giorni i tempi di accensione, il quarto giorno il sistema in modo autonomo calcola la mezzanotte virtuale eseguendo una regolazione del flusso regolando la lampada come indicato sullo schema di Fig. 1; per i primi tre giorni quindi il sistema manterrà le lampade accese al 100%, nel tempo di accensione dell'impianto, il quarto giorno entrerà in funzione il sistema DYNA CONTROL gestendo in modo autonomo il flusso luminoso garantendo così un notevole risparmio energetico. Accensioni inferiori ad 1 ora (es. manutenzione) verranno ignorate ed il sistema non entra in funzione, per accensioni da 1 a 4 ore (es. anomalia impianto) o superiori alle 23 ore (es. impianto sempre acceso), il sistema resetta il timer quindi ricomincerà a contare per i primi 3 giorni e successivamente riprenderà il funzionamento automatico.

DYNA CONTROL is an automatic system to control lamp brightness. The system starts working when first switched-on calculating switch-on times for 3 days, on the fourth day the system autonomously calculates the virtual midnight, adjusting the brightness of the lamp as indicated in fig.1. Therefore, for the first three days the system will keep the lamps on at 100%, during system switch-on, on the fourth day, the DYNA CONTROL system will start operating autonomously, controlling the lamp's brightness, thus ensuring significant energy savings.

Switch-on of less than 1 hour (ex. for maintenance) will be ignored and the system will not operate. For switch-on times from 1 to 4 hours (ex. system anomaly) or over 23 hours (ex. system always on), the system resets the timer and will restart counting for the first 3 days and then resume to automatic operation.

Fig. 1  
Esempio applicativo 2 steps - Application example 2 step

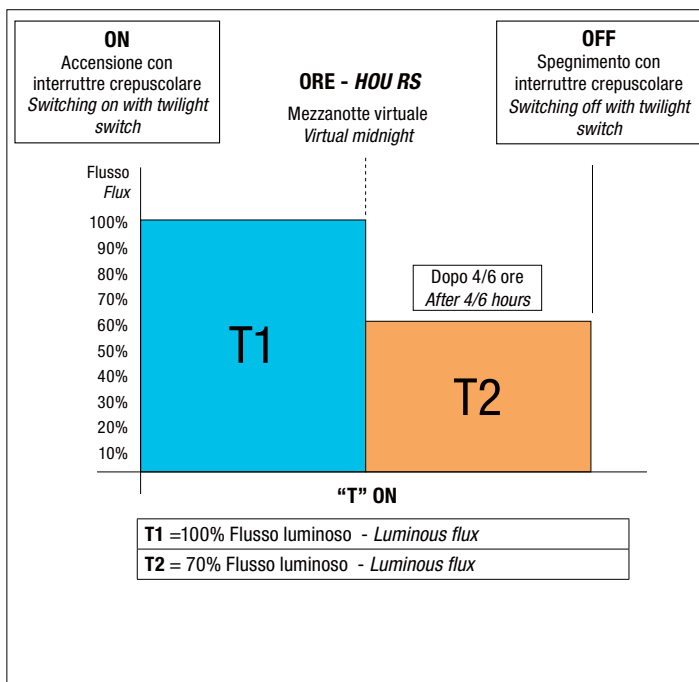
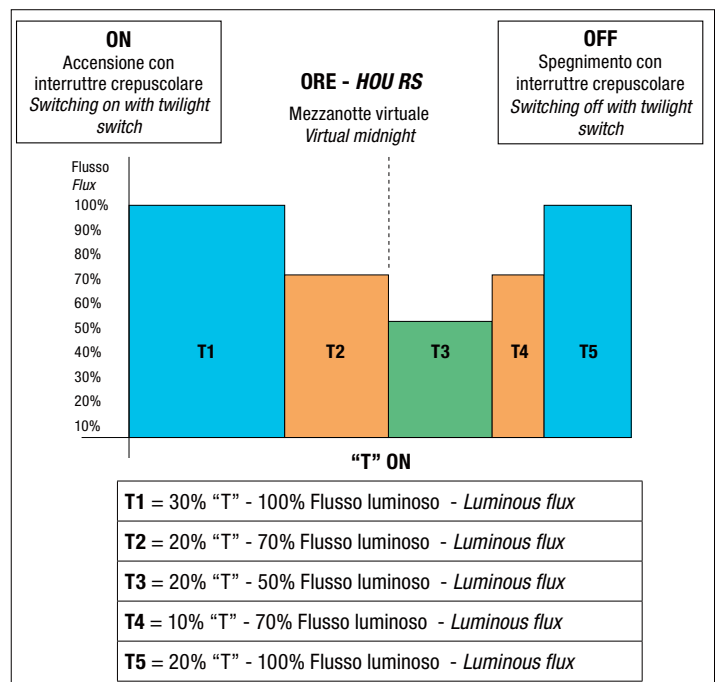



Fig. 2  
Esempio applicativo 5 steps - Application example 5 step



# SISTEMI GESTIONE DELLA LUCE OUTDOOR - SENSORE DI RILEVAMENTO ON BOARD



 Sensore integrato nell'apparecchio di illuminazione  
Sensor integrated into the lighting fixture

**Cod. HRC-XXXX - Telecomando NON incluso/NOT included accessory**  
L'utilizzo del telecomando permette ad installazione avvenuta di modificare le impostazioni senza dover accedere direttamente all'apparecchio.  
Using the remote control allows you to change the settings once installation has been completed without having to access the appliance directly.

## TARATURA DI FABBRICA - FACTORY CALIBRATION

L'apparecchio ha la seguente taratura di fabbrica  
The device has the following factory calibration

Tempo di attesa Hold time	5s
Luce ambiente Ambient light	OFF
tempo stand-by stand-by time	0s
Livello dimmerazione stand-by Stand-by dimming level	10%
Area di rilevamento Detection area	100%

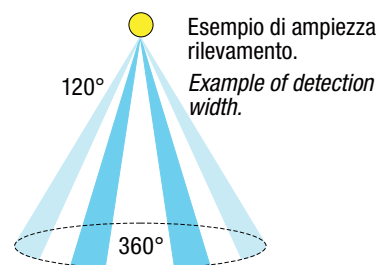
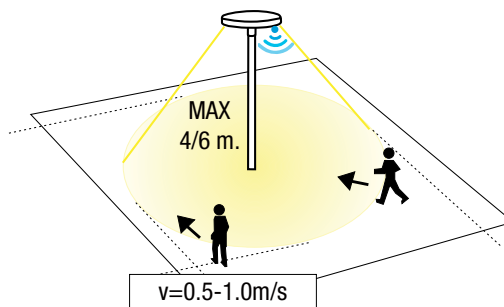

Street furniture

## ESEMPIO DI FUNZIONAMENTO - OPERATIONAL EXAMPLE

Quando non vi è nessun movimento, gli apparecchi mantengono un livello di illuminazione per un tempo preimpostato.  
When there is no motion, the fixtures maintain a lighting level for a preset time.

Al passaggio nell'area di rilevamento, gli apparecchi regolano l'intensità luminosa al 100%.  
When passing through the detection area, the devices adjust the light intensity to 100%.

Se non viene rilevato nessun passaggio, dopo un tempo predefinito di attesa, il sensore riporta l'intensità luminosa al valore preimpostato in precedenza.  
If no passage is detected, after a pre-set waiting time, the sensor returns the light intensity to the previously preset value.



# Pali conici dritti - Straight conical poles

## CICLO DI FABBRICAZIONE

### Spianatura e taglio della lamiera

Il rotolo di lamiera viene spianato mediante un impianto combinato “raddrizzatrice-spianatrice”, con rifilatura ai bordi per ottenere le adeguate tolleranze dimensionali. Il foglio di lamiera viene successivamente tagliato da una cesoia longitudinale ottenendo due trapezi uguali.

### Formatura tronco-conica

Il trapezio viene sottoposto a formatura a tronco di cono utilizzando presse piegatrici asservite da manipolatori automatici a controllo numerico.

### Saldatura

I lembi del tronco di cono vengono uniti longitudinalmente mediante procedimenti di saldatura automatici e manuali. Le saldature vengono effettuate nel rispetto di specifiche tecniche di lavorazione (WPS) conformi alle norme UNI EN ISO 15609-2 ed adottando procedimenti qualificati (WPAR) conformi alle norme UNI EN ISO 15614-1. Tutti gli addetti alla saldatura sono qualificati con patentino secondo le norme UNI EN ISO 14732 e UNI EN ISO 9606.

### Finitura

Conclusa la fase di saldatura il palo viene sottoposto a specifiche lavorazioni alla base (es. asole) ed in punta (es. calibratura).

### Collaudi

Ogni fase di lavorazione è sottoposta a controllo costante da parte degli addetti che operano sotto la supervisione del Responsabile dell'Ufficio Controllo Qualità.

## MANUFACTURING CYCLE

### Sheet metal straightening and cutting

The sheet metal roll is straightened using a combined “straightening-straightening” system, with trimming at the edges to obtain the appropriate dimensional tolerances. The sheet metal is then cut by a longitudinal shear to obtain two equal trapeziums.

### Truncated cone forming

The trapezium is subjected to truncated cone forming using press brakes served by automatic numerically controlled manipulators.

### Welding

The edges of the truncated cone are joined longitudinally using automatic and manual welding processes. The welds are carried out in compliance with specific processing techniques (WPS) compliant with the UNI EN ISO 15609-2 standards and adopting qualified procedures (WPAR) compliant with the UNI EN ISO 15614-1 standards. All welding personnel are qualified with a license according to UNI EN ISO 14732 and UNI EN ISO 9606 standards.

### Finishing







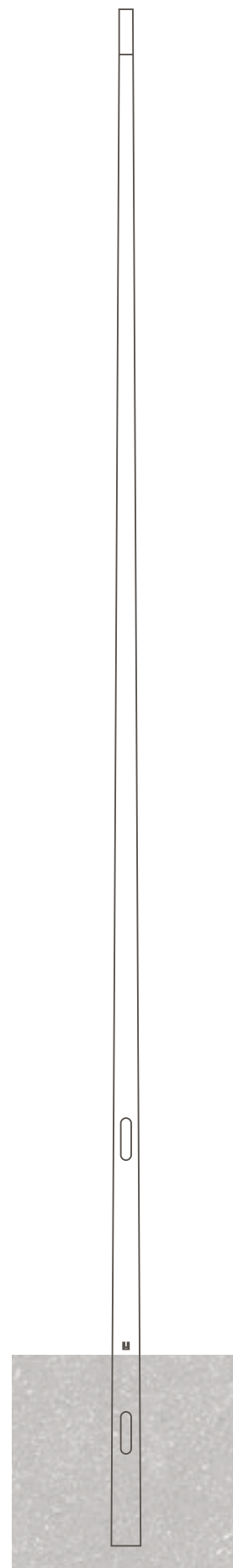
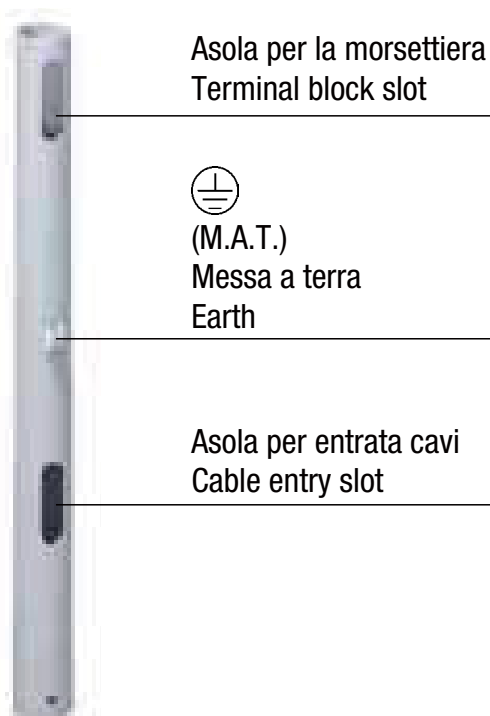



Once the welding phase is completed, the pole is subjected to specific processes at the base (e.g. slots) and at the tip (e.g. calibration).

### Testing

Each processing phase is subject to constant monitoring by personnel who operate under the supervision of the Quality Control Office Manager.













## Pali conici dritti - Straight conical poles

Code											
3500/3	3.000	500	3	60x95	21	0,85	38x132	1500	350	900x800	200x500
4000/3	3.500	500	3	60x100	25	1,00	38x132	1500	350	900x800	200x500
4500/3	4.000	500	3	60x105	28	1,17	38x132	1500	350	950x800	250x500
5000/3	4.500	500	3	60x110	32	1,33	38x132	1500	350	950x800	250x500
5500/3	5.000	500	3	60x115	37	1,51	38x132	1500	350	950x800	250x500
6000/3	5.500	800	3	60x120	42	1,70	38x132	1500	350	1050x800	300x500
6800/3	6.000	800	3	60x128	48	2,01	46x186	1800	600	1000x1100	300x800
6800/4	6.000	800	4	60x128	63	2,01	46x186	1800	600	1050x1100	300x800
7800/3	7.000	800	3	60x138	58	2,42	46x186	1800	600	1000x1100	300x800
7800/4	7.000	800	4	60x138	77	2,42	46x186	1800	600	1000x1100	300x800
8800/3	8.000	800	3	60x148	69	2,87	46x186	1800	600	1000x1100	300x800
8800/4	8.000	800	4	60x148	91	2,87	46x186	1800	600	1150x1100	300x800

**Acciaio S235JR - UNI EN10025 - Steel S235JR - UNI EN10025**

**A richiesta pali di altezze superiori - Poles of higher heights available on request**

Legenda simboli - Symbols legend	
	Altezza palo fuori terra (mm) - Pole height above ground (mm)
	Interramento palo (mm) - Pole burial (mm)
	Spessore (mm) - Thickness (mm)
	Diametro di sommità e base (mm) - Diameter of top and base (mm)
	Peso totale (Kg) - Total weight (Kg)
	Superficie verniciatura (m2) - Painting surface (m2)
	Asola di entrata per cavi e morsettiera (mmxmm) - Cable entry slot and terminal block (mmxmm)
	Posizionamento asola entrata per la morsettiera da base palo (mm) Positioning of the entry slot for the terminal block from the base of the pole (mm)
	Posizionamento asola entrata per per i cavi da base palo (mm) Positioning of entry slot for cables from pole base (mm)
	Dimensioni del plinto monoblocco a base quadrata LxH (mm) Dimensions of the square-based monobloc plinth LxH (mm)
	Foro nel plinto di formazione per innesto del palo ØxH (mm) Hole in the training plinth for pole insertion ØxH (mm)

# LED Lampione 14



Gamma di apparecchi a LED per illuminazione di aree urbane. Ideale per l'illuminazione di strade, vicoli, parcheggi, aree residenziali. I prodotti sono stati costruiti conformemente alle normative vigenti, anche facendo riferimento alle leggi contro l'inquinamento luminoso.

**Attacco palo:** in alluminio pressofuso idoneo per pali Ø min 45mm Ø max 60mm. Orientabile da  $\pm 0$  a  $\pm 20^\circ$  o a "frusta".

**Corpo:** in alluminio pressofuso UNI EN 1706.

**Verniciatura:** il ciclo di verniciatura standard a liquido, ad immersione, è composto da diverse fasi.

Una prima fase di pretrattamento superficiale del metallo, poi una verniciatura in cataforesi episodica resistente alla corrosione e alle nebbie saline, poi una mano finale di liquido bicomponente acrilico, stabilizzato ai raggi UV.

Per ambienti marini (fronte mare) conforme alla Norma UNI EN ISO 9227 (circa 1.000 ore)

**Colore:** Grigio RAL 9007 (a richiesta Nero RAL 9005)

**Ottica:** stradale diffondente (altre ottiche a richiesta)

**Guarnizione:** in poliuretano a celle chiuse dalle rilevanti prestazioni meccaniche ed elastiche

**Sorgente:** LED LUMILEDS 5050

Mantenimento del flusso luminoso 90% - L90B10 > 100.000h per il 90% dei LED.

**Temperatura di colore:** 3000K / 4000K (altre temperature di colore a richiesta):

**Cablaggio:** con cavo di alimentazione lunghezza 30cm

**Power factor:**  $\geq 0,95$

**A richiesta protezione alle sovratensioni:**

modo differenziale 6kV (L-N)

modo comune 8kV (L-GND, N-GND, L&N-GND)

**Norme di riferimento:** IEC 61000-4-5; EN60598-1; EN60598-2-1; EN62471; EN62031; EN60598-2-5; EN61547

*Range of LED luminaires to light up urban areas. Suitable for streets, narrow roads, car parks and residential areas lighting. The products are developed in compliance with norms currently in force, also referring to legislation regarding light pollution.*

**Pole attachment:** in die-cast aluminum suitable for min Ø 45mm max 60mm poles can be pivoted  $\pm 0$  to  $\pm 20^\circ$  or side mounting.

**Body:** made by UNI EN 1706 die-cast aluminum

**Painting:** the standard liquid painting cycle, by immersion, is made up of different phases.

A first phase of surface pre-treatment of the metal, then an episodic cathoresis painting resistant to corrosion and salt spray, then a final coat of two-component acrylic liquid, stabilized against UV rays.

For marine environments (seafont) compliant with the UNI EN ISO 9227 standard (approximately 1,000 hours)

**Colour:** RAL 9007 Grey color (on demand RAL 9005 Black color)

**Optic:** stree diffused (other optics on request)

**Gasket:** made by closed cell polyurethane with high mechanical and elastic performance

**Light source:** LED LUMILEDS

Maintenance of minimum luminous flux - L90B10 > 100.000h for 90% of LED.

**Color temperature:** 3000K;

**Source:** LUMILEDS 5050;

**Wiring:** with supply cable, length 30cm

**Power factor:**  $\geq 0,95$

**On demand surge protection:**

differential mode 6kV (L-N)

standard mode 8kV (L-GND, N-GND, L&N-GND).

**Standard reference:** IEC 61000-4-5; EN60598-1; EN60598-2-1; EN62471; EN62031; EN60598-2-5; EN61547

**DYNA**

Il settaggio del FLUSSO LUMINOSO avviene con programmazione della corrente di pilotaggio.

Tale programmazione va richiesta in sede, durante la fase d'ordine / progetto.

*The LUMINOUS FLUX setting is done by programming the driving current. This programming must be requested on site, during the order / project phase*

A richiesta - On demand



Vedi Pag. VI

See page VI

100-240 Vac	50/60 Hz	IP66	IK09	CRI > 70	+40 C° -20		CE	850°			
<b>Driver included</b> 		<b>RG0</b> 		<b>LOW FLICKER</b> 							



A richiesta  
Nero RAL 9005.  
Aggiungere BL dopo il codice  
On demand  
Black RAL 9005.  
Add BL after the code

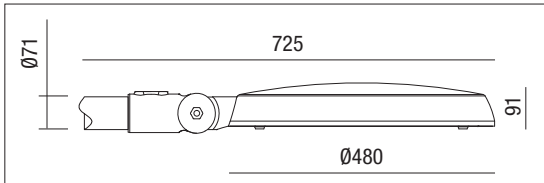

colour	W	Optic	K	nominal lm tc = 25°C	lm output	lm/W	pcs	Kg	CELL
G	50	ST	2700	8.200	7.250	145	1	5,00	31545-27
G	75	ST	2700	12.300	10.900	145	1	5,00	31575-27
G	20	ST	4000	3.300	2.900	145	1	5,00	31525
G	30	ST	4000	4.900	4.350	145	1	5,00	31530
G	40	ST	4000	6.600	5.800	145	1	5,00	31540
G	50	ST	4000	8.200	7.250	145	1	5,00	31545
G	60	ST	4000	9.800	8.700	145	1	5,00	31560
G	75	ST	4000	12.300	10.900	145	1	5,00	31575
G	20	ST	3000	3.300	2.900	145	1	5,00	31525-3K
G	30	ST	3000	4.900	4.350	145	1	5,00	31530-3K
G	40	ST	3000	6.600	5.800	145	1	5,00	31540-3K
G	50	ST	3000	8.200	7.250	145	1	5,00	31545-3K
G	60	ST	3000	9.800	8.700	145	1	5,00	31560-3K
G	75	ST	3000	12.300	10.900	145	1	5,00	31575-3K
G	20	ST	4000	3.300	2.900	145	1	5,00	31525-DA
G	30	ST	4000	4.900	4.350	145	1	5,00	31530-DA
G	40	ST	4000	6.600	5.800	145	1	5,00	31540-DA
G	50	ST	4000	8.200	7.250	145	1	5,00	31545-DA
G	60	ST	4000	9.800	8.700	145	1	5,00	31560-DA
G	75	ST	4000	12.300	10.900	145	1	5,00	31575-DA
G	20	ST	3000	3.300	2.900	145	1	5,00	31525-DA-3K
G	30	ST	3000	4.900	4.350	145	1	5,00	31530-DA-3K
G	40	ST	3000	6.600	5.800	145	1	5,00	31540-DA-3K
G	50	ST	3000	8.200	7.250	145	1	5,00	31545-DA-3K
G	60	ST	3000	9.800	8.700	145	1	5,00	31560-DA-3K
G	75	ST	3000	12.300	10.900	145	1	5,00	31575-DA-3K
G	20	ST	4000	3.300	2.900	145	1	5,00	31525-DY
G	30	ST	4000	4.900	4.350	145	1	5,00	31530-DY
G	40	ST	4000	6.600	5.800	145	1	5,00	31540-DY
G	50	ST	4000	8.200	7.250	145	1	5,00	31545-DY
G	60	ST	4000	9.800	8.700	145	1	5,00	31560-DY
G	75	ST	4000	12.300	10.900	145	1	5,00	31575-DY
G	20	ST	3000	3.300	2.900	145	1	5,00	31525-DY-3K
G	30	ST	3000	4.900	4.350	145	1	5,00	31530-DY-3K
G	40	ST	3000	6.600	5.800	145	1	5,00	31540-DY-3K
G	50	ST	3000	8.200	7.250	145	1	5,00	31545-DY-3K
G	60	ST	3000	9.800	8.700	145	1	5,00	31560-DY-3K
G	75	ST	3000	12.300	10.900	145	1	5,00	31575-DY-3K

DALI 2

DALI 2

DALI 2

DALI 2

DALI 2

DALI 2

DALI 2

DALI 2

DALI 2

DALI 2

DALI 2

DALI 2

DYNA

DYNA

DYNA

DYNA

DYNA

DYNA

DYNA

DYNA

DYNA

DYNA

DYNA

DYNA

# LED Lampione 14



Connettore rapido IP68 incluso  
IP68 quick connector included



Connettore rapido IP68 incluso  
IP68 quick connector included

# LED Lampione 14

Accessori non inclusi - *Not included accessories*



Street furniture



Code: 10001465

Adattatore palo da Ø 60mm  
a Ø 76mm.  
*Up Ø 60mm to Ø 76mm  
adapter pole.*



Code: 220001236

Braccio a parete  
*Wall bracket*

## ZHAGA SOCKET



Code: 488787561

Connettore max 30Vdc - max 1,5A  
Connector max 30Vdc - max 1,5A

Code: 488787581

Tappo IP66  
Cap connector IP66

## Ottica - Optic

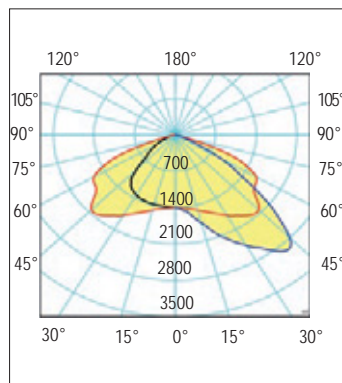

ST/CDL  
Stradale - *Street optic*



La certificazione fotometrica dei nostri apparecchi viene sempre effettuata da un istituto esterno. Efficienza luminosa e "lm Output" sono quindi il risultato di tale istituto.

*The photometric certification of our appliances is always carried out by an external institute. Luminous efficiency and "lm Output" are therefore the result of this institute.*

A richiesta - On demand

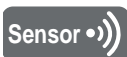

Vedi Pag. VI  
See page VI

Gamma di apparecchi a LED per illuminazione di aree urbane. Ideale per l'illuminazione di strade, parcheggi, aree residenziali.

**Installazione:** attacco palo in alluminio pressofuso idoneo per pali di diametro min. 55mm - max. 65mm, orientabile da  $\pm 0$  a  $\pm 20^\circ$  o a "frusta".

**Corpo e telaio:** in alluminio pressofuso UNI EN 1706 verniciato con polvere termoindurente poliestere.

**Imbocco a palo:** in alluminio pressofuso UNI EN 1706, verniciato con polvere termoindurente poliestere, con goniometro graduato per un corretto puntamento del fascio luminoso.

**Verniciatura:** di tipo poliestere eseguita a polvere, resistente agli agenti atmosferici e alla corrosione e garantita per 1.200 ore in nebbia salina (ISO 9227). Colore Grigio RAL 9007 (a richiesta RAL 1013).

**Schermo:** vetro temperato di spessore 4mm resistente agli shock termici e agli urti.

**Ottica:** In PMMA con resistenza alle alte temperature, agli shock termici e agli urti.

**Sorgente:** LED LUMILEDS 5050

Mantenimento del flusso luminoso minimo al 90% - L90B10 > 100.000h per il 90% dei LED.

**Temperatura di colore:** 4000K; altre temperature di colore a richiesta (2200K - 2700K - 3000K - 5000K - Consegna 60 giorni).

**Protezione alle sovratensioni inclusa:**

Modo differenziale 6kV (L-N)

Modo comune 8kV (L-GND, N-GND, L&N-GND)

**A richiesta:** versione con protezione maggiorata (10kV) contro gli impulsi aggiungendo il cod. RO0640/N.

**Driver:** incorporato

Fattore di potenza  $\geq 0,98$ .

**Norme di riferimento:** IEC 61000-4-5; EN60598-1; EN60598-2-1; EN62471; EN62031; EN60598-2-3; EN61547

*Range of LED luminaires to light up urban areas. Suitable for roads, car parks and residential areas lighting.*

**Installation:** mast top mounting in die cast aluminium suitable for poles with a diameter of min. 55mm - max. 65mm, that can be pivoted  $\pm 0$  to  $\pm 20^\circ$  or side mounting

**Housing and frame:** made by UNI EN 1706 die-cast aluminium, coated with polyester thermoset powder.

**Pole entrance:** made by UNI EN 1706 die-cast aluminium, coated with polyester thermoset powder, with graduated goniometer to allow the correct orientation of light beam.

**Coating:** coated with powdered polyester, resistant to atmospheric agents, corrosion and guaranteed for 1.200 hours in saline mist (ISO 9227).

Grey RAL 9007 color (on demand RAL 1013).

**Shield:** tempered glass with 4mm thickness resistant to thermal shocks and collisions.

**Optic:** PMMA optic with high temperature resistance, thermal shock and impact resistance

**Light source:** LED LUMILEDS 5050

Maintenance of minimum luminous flux to 90% - L90B10 > 100.000h for 90% of LED.

**Color temperature:** 4000K; other color temperatures available on demand (2200K - 2700K - 3000K - 5000K. Delivery time: 60 days)

**Protection against overvoltages included:**

Differential mode 6kV (L-N)

Standard mode 8kV (L - GND, N-GND, L&N-GND).

**On demand:** this version with greater protection (10kV) with code RO0640/N.

**Driver:** included

Power factor  $\geq 0,98$

**Standard reference:** IEC 61000-4-5; EN60598-1; EN60598-2-1; EN62471; EN62031; EN60598-2-3; EN61547

# LED Minisempione - LED Sempione - LED Maxisempione - LED Megasempione

## Durata e Aspettativa di vita del LED

Contrariamente alle lampade tradizionali, il LED non si spegne improvvisamente all'esaurimento della sua vita utile, ma diminuisce, in tempi molto lunghi, il flusso iniziale fino al suo completo esaurimento. Il LED non si rompe (se non per difettosità), ma subisce un decadimento continuo dell'efficienza. La durata di vita utile indica la percentuale di decadimento del flusso luminoso (L) riferita ad un numero di ore utili di funzionamento. L'aspettativa di Vita (B) indica la percentuale di componenti che, raggiunte le ore utili di funzionamento, non mantengono le caratteristiche di flusso luminoso dichiarate. Per esempio un LED dichiarato L80/B10=100.000 ore, indica che al raggiungimento delle 100.000 ore il 90% (B10) dei moduli LED fornisce ancora l'80% del flusso luminoso iniziale (L80)

## LED service life expectancy

Unlike traditional lamps, they do not tend to go out suddenly at the end of their useful life, but slowly decrease in flux until they expire. The LED does not break (unless it is defective), but declines gradually in performance. The drop in LED flux, defined as the useful life, is represented by the acronym L80 (see graph), which means flux at 80%. Value "B" followed by a value between 10 and 50 indicates the quality of the component being used, defining the percentage of LED that does not maintain the declared characteristics when the 100,000 hours have elapsed.

LED: mantenimento del flusso luminoso - TM21 (compreso fine del ciclo di vita) LED: maintenance of the lighting flux - TM21 (including end of life cycle)						
	n° LED	W	L80B10 @ta: +25°C	L80B10 @ta: +45°C	L90B10 @ta: +25°C	L90B10 @ta: +45°C
LED Minisempione	128	50	> 100.000 h	> 100.000 h	70.000 h	50.000 h
	128	75				
LED Sempione	192	95	> 100.000 h	> 100.000 h	70.000 h	50.000 h
	192	120				
LED Maxisempione	320	160	> 100.000 h	> 100.000 h	70.000 h	50.000 h
	80	210				
LED Megasempione	144	250	> 100.000 h	> 100.000 h	70.000 h	50.000 h
	144	300				

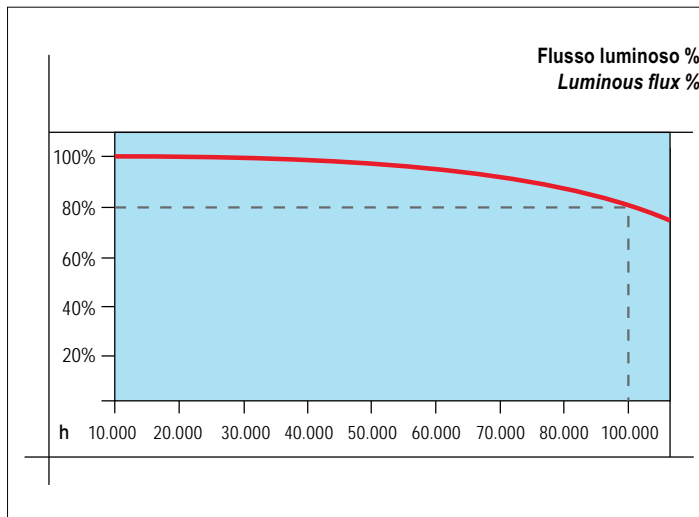

Test LM79 - LM82 - TM21  
certificato da laboratorio accreditato

LM79 - LM82 - TM21 Test  
certified by an external laboratory

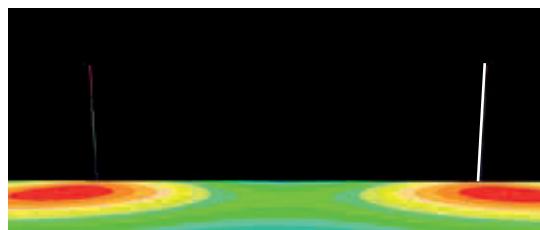

### ST/CDL

**ST1,1** - l = 12h / d = 1,1  
Intensity class: G\*3

**ST0,9** - l = 15h / d = 0,9 / h <= 16  
Intensity class: G\*3

**ST1,3** - l = 10h / d = 1,3  
Intensity class: G\*3

Classi di intensità CEN (classificazione provvisoria) e valore stimato del relativo ULOR massimo - CEN intensity classes (provisional classification) and estimated value of its maximum ULOR

Class	70truept o	80truept o	90truept o	95truept o	
Prelim.					
G1		200 cd/klm	50 cd/klm		~ 31%
G2		150 cd/klm	30 cd/klm		~ 18,8%
G3		100 cd/klm	20 cd/klm		~ 12,6%
G4	500 cd/klm	100 cd/klm	10 cd/klm	0 cd/klm	~ 0,55%
G5	350 cd/klm	100 cd/klm	10 cd/klm	0 cd/klm	~ 0,55%
G6	350 cd/klm	100 cd/klm	0 cd/klm	0 cd/klm	0%

Street furniture



I modelli della serie LED Sempione sono conformi alle prove di vibrazione, secondo la Norma EN 60598-1 certificata da Ente esterno: Illuminazione stradale - Vibrazione degli apparecchi di illuminazione

The models of the LED Sempione series comply with vibration tests, according to the EN 60598-1 standard certified by the external body: Street lighting - Vibration of lighting fixtures

220-240 Vac	110 Vac On demand	50/60 Hz	IP66	IK09	CRI > 70	+45°C -30°C	CE	17	N		
850°			IECEE	LOW FLICKER	RG0	DRIVER INCLUDED MULTIPOWER RIPPLE FREE	RoHS compliance				

## LED Minisempione

## On demnad D4I + Zhaga SOCKET

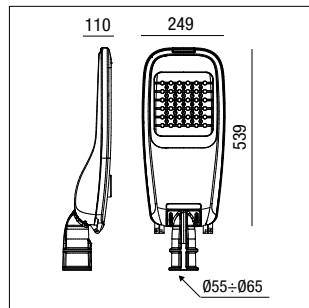

colour	W	Optic	K	nominal lm tc = 25°C	lm output	lm/W	pcs	Kg	CELL
G	30	ST	2200	5.600	4.950	165	1	5,00	36000/30/2KS
G	30	ST	2700	5.600	4.950	165	1	5,00	36000/30/27K
G	20	ST	4000	3.700	3.300	165	1	5,00	36000/20S
G	30	ST	4000	5.600	4.950	165	1	5,00	36000/30S
G	40	ST	4000	7.600	6.600	165	1	5,00	36000/40S
G	50	ST	4000	9.300	8.250	165	1	5,00	36000S
G	60	ST	4000	11.200	9.900	165	1	5,00	36001/60S
G	75	ST	4000	13.900	12.400	165	1	5,00	36001S
G	50	ST	3000	9.300	8.250	165	1	5,00	36000/3KS
G	75	ST	3000	13.900	12.400	165	1	5,00	36001/3KS
G	100	ST	3000	18.600	16.500	165	1	5,00	37001/3K
G	100	ST	4000	18.600	16.500	165	1	5,00	37001
DALI 2	G	20	ST	4000	3.700	3.300	1	5,00	36000/20DA
DALI 2	G	30	ST	4000	5.600	4.950	1	5,00	36000/30DA
DALI 2	G	40	ST	4000	7.600	6.600	1	5,00	36000/40DA
DALI 2	G	50	ST	4000	9.300	8.250	1	5,00	36000SDA
DALI 2	G	60	ST	4000	11.200	9.900	1	5,00	36001/60DA
DALI 2	G	75	ST	4000	13.900	12.400	1	5,00	36001DA
DYNA	G	20	ST	4000	3.700	3.300	1	5,00	36000/20DY
DYNA	G	30	ST	4000	5.600	4.950	1	5,00	36000/30DY
DYNA	G	40	ST	4000	7.600	6.600	1	5,00	36000/40DY
DYNA	G	50	ST	4000	9.300	8.250	1	5,00	36000SDY
DYNA	G	60	ST	4000	11.200	9.900	1	5,00	36001/60DY
DYNA	G	75	ST	4000	13.900	12.400	1	5,00	36001DY
DYNA	G	100	ST	3000	18.600	16.500	1	5,00	37001/3KDY
DYNA	G	100	ST	4000	18.600	16.500	1	5,00	37001DY

## LED Sempione

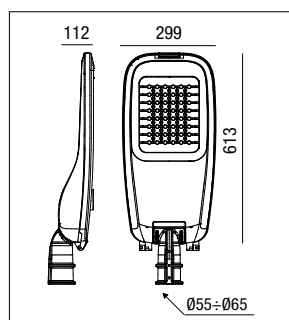

colour	W	Optic	K	nominal lm tc = 25°C	lm output	lm/W	pcs	Kg	CELL
G	95	ST	2200	17.600	15.600	165	1	6,00	36100/2KS
G	95	ST	2700	17.600	15.600	165	1	6,00	36100/27K
G	95	ST	4000	17.600	15.600	165	1	6,00	36100S
G	120	ST	4000	22.300	19.800	165	1	6,00	36200
G	95	ST	3000	17.600	15.600	165	1	6,00	36100/3KS
G	120	ST	3000	22.300	19.800	165	1	6,00	36200/3K
G	140	ST	4000	26.100	23.100	165	1	6,00	37144
DALI 2	G	95	ST	2200	17.600	15.600	1	6,00	36100/2KDA
DALI 2	G	95	ST	2700	17.600	15.600	1	6,00	36100/27KDA
DALI 2	G	95	ST	4000	17.600	15.600	1	6,00	36100DA
DALI 2	G	120	ST	4000	22.300	19.800	1	6,00	36200DA
DALI 2	G	95	ST	3000	17.600	15.600	1	6,00	36100/3KDA
DALI 2	G	120	ST	3000	22.300	19.800	1	6,00	36200/3KDA
DYNA	G	95	ST	2200	17.600	15.600	1	6,00	36100/2KDY
DYNA	G	95	ST	2700	17.600	15.600	1	6,00	36100/27KDY
DYNA	G	95	ST	4000	17.600	15.600	1	6,00	36100DY
DYNA	G	120	ST	4000	22.300	19.800	1	6,00	36200DY
DYNA	G	95	ST	3000	17.600	15.600	1	6,00	36100/3KDY
DYNA	G	120	ST	3000	22.300	19.800	1	6,00	36200/3KDY
DYNA	G	140	ST	4000	26.100	23.100	1	6,00	37144DY



# LED Minisempione - LED Sempione - LED Maxisempione - LED Megasempione

## Dettagli Details



**Completo di dispositivo anticondensa.**  
Pressacavo con valvola di compensazione e riciclo dell'aria  
**Complete with anti-condensate device.**  
Cable gland with valve for compensation and circulation of air.



**Completo di sezionatore di linea in doppio isolamento** che interrompe l'alimentazione elettrica all'apertura del body.  
**Complete with line disconnector in double insulation** that interrupts the power supply when the body is opened.

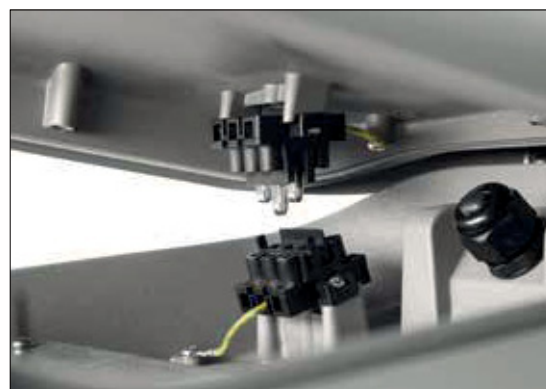

**Completo di connettore IP68** per una rapida installazione  
**Complete with IP68 connector** for quick installation

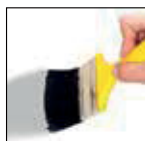

**A richiesta:** verniciatura resistente a 2.000 ore di esposizione alla nebbia salina in accordo alla norma ISO 9227 certificato da Ente esterno.

**On request:** painting resistant to 2,000 hours of exposure to salt spray in accordance with ISO 9227 certified by an external body.



**Ottiche:** realizzate in PMMA resistenti ai raggi UV

**Optics:** made in PMMA resistant to UV radiation

## Accessori NON inclusi - Accessories NOT included



Code: 220001236  
Braccio a parete  
Wall bracket

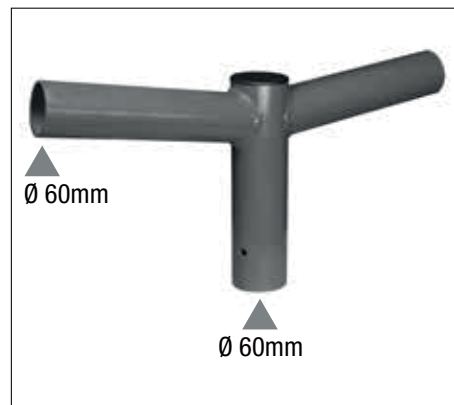

Cod. 802020.0101  
Braccio 2X - 2X bracket

### ZHAGA SOCKET



- Connettore max 30Vdc - max 1,5A  
Connector max 30Vdc - max 1,5A  
**Code:** 488787561  
- Tappo IP66 - Cap connector IP66  
**Code:** 488787581

Regolazione 1÷10V 1÷10V control	DALI 2	Mezzanotte virtuale Virtual midnight	Zhaga Socket	Telegestione sistema Wi-Fi (da concordare) Wi-Fi system remote management (to be agreed)
Possibilità di regolazione 10% - 100% con sistema 1÷10V Possibility of adjustment 10% - 100% with 1-10V system	Possibilità di regolazione 10% - 100% con sistema DALI 2 Possibility of adjustment 10% - 100% with DALI 2 system	Sistema con riduzione automatica del flusso System with automatic flux reduction	Predisposizione sul corpo dell'apparecchio. Ideale per la gestione dell'illuminazione autonoma locale tramite sensori o da remoto. For installation on the body of the appliance. Ideal for autonomous management of the lighting, either locally with sensors or remotely	Sistema di controllo, gestione consumi e diagnosi dell'impianto con tecnologia Wi-Fi Control system, consumption management and diagnosis of the system with Wi-Fi technology

### DYNA control - Mezzanotte virtuale - Virtual midnight

#### DYNA

Il settaggio del FLUSSO LUMINOSO avviene con programmazione della corrente di pilotaggio. Tale programmazione va richiesta in sede, durante la fase d'ordine / progetto.  
The LUMINOUS FLUX setting is done by programming the driving current. This programming must be requested on site, during the order / project phase

DYNA CONTROL è un sistema automatico di controllo del flusso luminoso delle lampade. Il sistema entra in funzione alla prima accensione calcolando per 3 giorni i tempi di accensione, il quarto giorno il sistema in modo autonomo, calcola la mezzanotte virtuale eseguendo una regolazione del flusso regolando la lampada come indicato sullo schema di Fig. 1; per i primi tre giorni, quindi, il sistema manterrà le lampade accese al 100%, nel tempo di accensione dell'impianto, il quarto giorno entrerà in funzione il sistema DYNA CONTROL gestendo in modo autonomo il flusso luminoso garantendo così un notevole risparmio energetico.

Accensioni inferiori ad 1 ora (es. manutenzione) verranno ignorate ed il sistema non entra in funzione, per accensioni da 1 a 4 ore (es. anomalia impianto) o superiori alle 23 ore (es. impianto sempre acceso), il sistema resetta il timer quindi ricomincerà a contare per i primi 3 giorni e successivamente riprenderà il funzionamento automatico.

DYNA CONTROL is an automatic control system for the luminous flux of the lamps. The system comes into operation at the first start-up by calculating the ignition times for 3 days, on the fourth day the system autonomously calculates the virtual midnight by adjusting the flow by adjusting the lamp as indicated in the diagram in Fig. 1; for the first three days, therefore, the system will keep the lamps on at 100%, during the system start-up time, on the fourth day the DYNA CONTROL system will come into operation, independently managing the luminous flux thus ensuring significant energy savings.

Switch-ons of less than 1 hour (e.g. maintenance) will be ignored and the system does not start up, for switch-ons from 1 to 4 hours (e.g. system anomaly) or longer than 23 hours (e.g. system always on), the system resets the timer will then start counting again for the first 3 days and will then resume automatic operation.

Fig. 1 - Esempio applicativo 2 steps  
Application example 2 steps

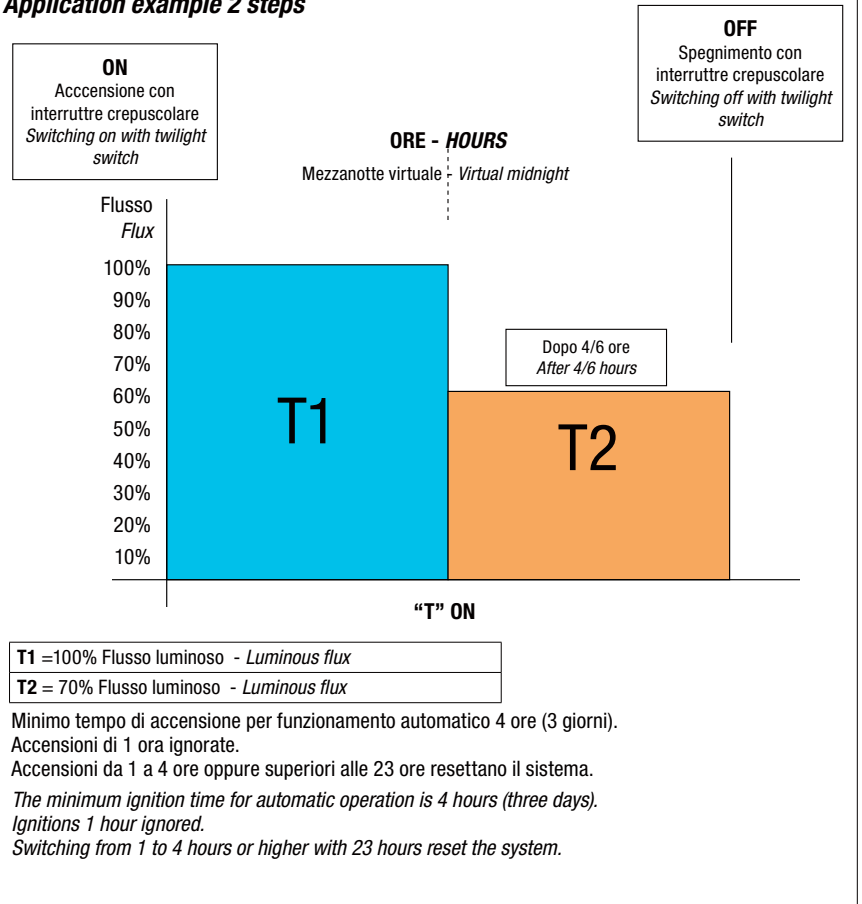

### CLO - Constant Light Output

Tutte le fonti di luce (anche i LED) hanno una riduzione della produzione di luce nel corso del tempo. Per garantire il minimo richiesto di livelli di luce in un impianto, la maggior parte dei progetti di illuminazione sono calcolate in base al livello di luce alla fine della vita utile della lampada (di norma il punto L70: 70% dei Lumen iniziali). Ciò significa che il sistema consuma più potenza del necessario, sprecando in media 15% di energia durante la sua vita (Fig. A).

L'emissione luminosa funzionalità costante (CLO) compensa questa perdita di luce, in modo che i LED siano in grado di fornire sempre il livello di luce necessaria. L'alimentatore può essere programmato per erogare corrente costante ad un livello ridotto per un nuovo apparecchio, ed aumentare gradualmente compensando il decadimento del flusso luminoso. Ciò influisce positivamente sulla vita della sorgente luminosa, sul risparmio energetico, prolungando la durata del sistema.

La regolazione della potenza erogata viene fatta in base al contatore delle ore di esercizio. Ad intervalli di tempo di 4.000 ore, il sistema incrementa la corrente del corrispondente valore di decadimento del flusso luminoso indicato dai costruttori della sorgente luminosa. In questo modo il flusso luminoso dell'apparecchio rimane costante per tutta la sua vita.

All light sources (including LEDs) produce less light over time. In order to guarantee the minimum required levels of light of a system, most lighting projects are planned taking into account the level of light at the end of the useful life of the lamp (normally point L70: 70% of initial lumen output). This means that the system consumes more power than necessary, wasting on average 15% of energy throughout its life (Fig. A).

The constant lumen output (CLO) compensates for this loss of light to ensure that the LEDs supply the required level of light at all times.

The power supply unit can be programmed to supply direct current at a reduced level for a new appliance, and to gradually increase this to compensate for the decline in luminous flux. This positively increases the lifespan of the light source and of the system, while ensuring energy savings.

The supply of power is adapted according to the operating hours counter.

After every 4,000 hours, the system increases the current in proportion to the decrease in the luminous flux indicated by the manufacturers of the light source. In this way, the luminous flux of the appliance remains constant during its entire life-span.

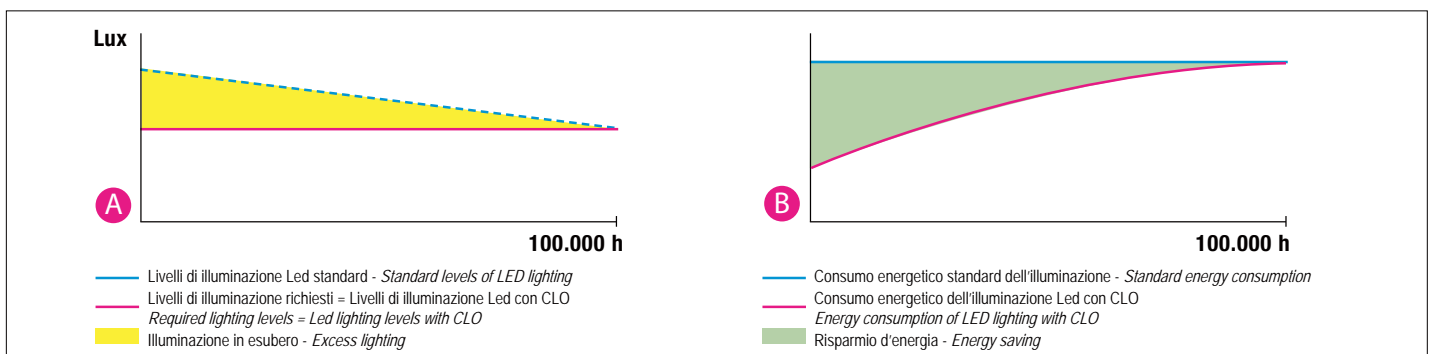

# Smart City

## Sistema di comunicazione Wireless

**Possibilità di coimplementazione di diverse tecnologie**  
**Programmazione e controllo da remoto mediante gateway in loco**  
**Monitoraggio in tempo reale dello stato del sistema e raccolta dati**  
**Idoneità al relamping per il risparmio energetico**  
**Ideale per applicazioni commerciali, industriali ed ambienti esterni**

Sistema estremamente efficiente, che combina soluzioni tecnologiche di prima qualità per il telecontrollo di luci e di oggetti IoT. Il sistema può monitorare, controllare e gestire le installazioni luminose, dalla singola lampada al network nel suo insieme.

Il sistema permette di coprire vaste aree e lo rende estremamente versatile in termini di compatibilità con una pluralità di dispositivi, è pensato per fornire soluzioni ad hoc sulla base delle necessità del singolo Cliente, copre una vasta gamma di applicazioni, che spaziano dalle aree commerciali agli edifici, dai capannoni industriali ai giardini pubblici, a città, strade e tunnel.

Impiegando diversi componenti è possibile gestire la luce a 360°, effettuare misurazioni di specifici parametri ambientali come l'inquinamento atmosferico, monitorare lo stato delle lampade (temperatura di funzionamento, consumi, eventuali difetti meccanici che potrebbero provocare danni ecc.) ed implementando sensori di movimento, creare heat map finalizzate alla definizione delle maggiori aree di concentrazione delle persone.

La programmazione dinamica della luce permette la gestione automatica del flusso luminoso della lampada in specifici intervalli di tempo. La funzione CLO consente di mantenere costante il flusso luminoso per tutta la durata di vita del prodotto, bilanciando elettronicamente la riduzione dell'efficienza tipica dei LED. Tutte le informazioni raccolte possono essere archiviate a gestire in loco o da remoto via Cloud.

**Messa in opera e installazione del sistema non incluse nel prezzo.**

## Wireless communication system

**Possibility of implementing several brand technologies**  
**Remote programming and control via on-site gateways**  
**Real-time monitoring of the system status and data collection**  
**Suitable for energy saving relamping**  
**Ideal for commercial, industrial and outdoor applications**

*Extremely efficient system, combining state-of the art- technological solution for the tele-control of light and objects. The system can monitor, control and manage the lighting installations ranging from the single lamp to the whole network.*

*The system allows to the cover extended areas makes it extremely versatile in terms of compatibility with a plurality of devices. This systems is thought to fulfil the need of providing and hoc solutions on the basis of the Customer requests. The system covers a very wide range of applications, ranging from commercial spaces to buildings, industrial plants, public gardens, cities, street and tunnels.*

*By implementing different components it is possible to manage the light at 360°; to make measurements of specific ambient parameters like air pollution and light intensity; to check the luminaire status (temperature, consumptions, any potentially dangerous mechanical faults etc..) and, by implementing movement sensors, to create heat maps aiming at defining the mains areas of people concentration.*

*All the collected information can be stored and managed on site or remotely via Cloud Service. The dynamic programming of the light enables to define an automatic management of the luminous flux emitted by the luminaire on the basis of time slots. The CLO function allows to keep the luminous flux constant along the life cycle of the luminaire, by electronically balancing the efficiency decrease, which is typical of the LEDs.*

**Installation and start-up of the system not included in the price**





Street furniture

# LED Mini Gran Sasso - LED Gran Sasso



La certificazione fotometrica dei nostri apparecchi viene sempre effettuata da un istituto esterno. Efficienza luminosa e "lm Output" sono quindi il risultato di tale istituto.

*The photometric certification of our appliances is always carried out by an external institute. Luminous efficiency and "lm Output" are therefore the result of this institute.*

A richiesta - On demand

1-10Vdc

DALI 2

DYNA

Wireless

Di

Vedi Pag. VI - See page VI

Gamma di apparecchi a LED per illuminazione di aree urbane. Ideale per l'illuminazione di strade, parcheggi, aree residenziali.

**Installazione:** attacco palo in alluminio pressofuso idoneo per pali di diametro min. 55mm - max. 65mm, orientabile da  $\pm 0$  a  $\pm 90^\circ$ .

**Corpo e telaio:** in alluminio pressofuso UNI EN 1706 verniciato con polvere termoindurente poliesteri.

**Imbocco a palo:** in alluminio pressofuso UNI EN 1706, verniciato con polvere termoindurente poliesteri, con goniometro graduato per un corretto puntamento del fascio luminoso.

**Verniciatura:** di tipo poliesteri eseguita a polvere, resistente agli agenti atmosferici e alla corrosione e garantita per 1.200 ore in nebbia salina (ISO 9227). Colore Nero RAL9005.

**Schermo:** vetro temperato di spessore 4mm resistente agli shock termici e agli urti.

**Ottica:** In PMMA con resistenza alle alte temperature, agli shock termici e agli urti.

**Sorgente:** LED **SAMSUNG LUMILEDS**  
Mantenimento del flusso luminoso minimo al 90% - (L90B10) >100.000h per il 90% dei LED.

**Temperatura di colore:** 4000K; altre temperature di colore a richiesta (2200K - 2700K - 3000K - 5000K - Consegna 60 giorni).

**Protezione alle sovratensioni inclusa:**

Modo differenziale 6kV (L-N)

Modo comune 8kV (L-GND, N-GND, L&N-GND)

A richiesta: versione con protezione maggiorata (10kV) contro gli impulsi aggiungendo il cod. R00640/N.

**Driver:** incorporato 

Fattore di potenza  $\geq 0,98$ .

**Norme di riferimento:** IEC 61000-4-5; EN60598-1; EN60598-2-1; EN62471; EN62031; EN60598-2-3; EN61547

*Range of LED luminaires to light up urban areas. Suitable for roads, car parks and residential areas lighting.*

**Installation:** pole attachment in die cast aluminium suitable for poles with a diameter of min. 55mm - max. 65mm, that can be pivoted  $\pm 0$  to  $\pm 90^\circ$ .

**Housing and frame:** made by UNI EN 1706 die-cast aluminium, coated with polyester thermoset powder.

**Pole entrance:** made by UNI EN 1706 die-cast aluminium, coated with polyester thermoset powder, with graduated goniometer to allow the correct orientation of light beam.

**Coating:** coated with powdered polyester, resistant to atmospheric agents, corrosion and guaranteed for 1.200 hours in saline mist (ISO 9227).

Black RAL 9005 color.

**Shield:** tempered glass with 4mm thickness resistant to thermal shocks and collisions.

**Optic:** PMMA optic with high temperature resistance, thermal shock and impact resistance

**Light source:** LED **SAMSUNG LUMILEDS**  
Maintenance of minimum luminous flux to 90% - (L90B10) >100.000h for 90% of LED.

**Color temperature:** 4000K; other color temperatures available on demand (2200K - 2700K - 3000K - 5000K. Delivery time: 60 days)

**Protection against overvoltages included:**

Differential mode 6kV (L-N)

Standard mode 8kV (L - GND, N-GND, L&N-GND).

**On demand:** this version with greater protection (10kV) with code R00640/N.

**Driver:** included 

Power factor  $\geq 0,98$

**Standard reference:** IEC 61000-4-5; EN60598-1; EN60598-2-1; EN62471; EN62031; EN60598-2-3; EN61547

## LED Mini Gran Sasso - LED Gran Sasso



LED Gran Sasso

LED Mini Gran Sasso

Apparecchio predisposto all'installazione su palo (Vedi Pag. 100)  
Device designed for pole installation (See page 100)

220-240 Vac	110 Vac On demand	50/60 Hz	IP66	IK09	CRI > 70	+45°C -30°C	CE			850°	
	TECEE	LOW FLICKER	RG0		DRIVER INCLUDED MULTIPOWER RIPPLE FREE	RoHS compliance		pending			

## LED Mini Gran Sasso

## On demand D4I + Zhaga SOCKET

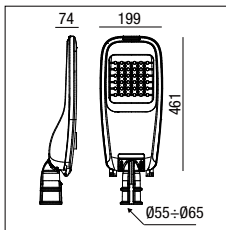

colour	W	Optic	K	nominal lm tc = 25°C	lm output	lm/W	pcs	Kg	CELL
N	20	ST	4000	3.700	3.300	165	1	2,20	346-20-4K
N	20	ST	3000	3.700	3.300	165	1	2,20	346-20-3K
N	30	ST	4000	5.000	4.950	165	1	2,20	346-30-4K
N	30	ST	3000	5.000	4.950	165	1	2,20	346-30-3K
N	40	ST	4000	7.450	6.600	165	1	2,20	346-40-4K
N	40	ST	3000	7.450	6.600	165	1	2,20	346-40-3K
N	50	ST	4000	9.300	8.250	165	1	2,20	346-50-4K
N	50	ST	3000	9.300	8.250	165	1	2,20	346-50-3K
N	60	ST	4000	11.200	9.900	165	1	2,20	347-60
N	75	ST	4000	14.000	12.400	165	1	2,20	347-75
DYNA	N	ST	4000	3.700	3.300	165	1	2,20	346-20-4K-DY
DYNA	N	ST	3000	3.700	3.300	165	1	2,20	346-20-3K-DY
DYNA	N	ST	4000	5.000	4.950	165	1	2,20	346-30-4K-DY
DYNA	N	ST	3000	5.000	4.950	165	1	2,20	346-30-3K-DY
DYNA	N	ST	4000	7.450	6.600	165	1	2,20	346-40-4K-DY
DYNA	N	ST	3000	7.450	6.600	165	1	2,20	346-40-3K-DY
DYNA	N	ST	4000	9.300	8.250	165	1	2,20	346-50-4K-DY
DYNA	N	ST	3000	9.300	8.250	165	1	2,20	346-50-3K-DY
DYNA	N	ST	4000	11.200	9.900	165	1	2,20	347-60DY
DYNA	N	ST	4000	14.000	12.400	165	1	2,20	347-75DY

Ottica di serie  
Standard optic

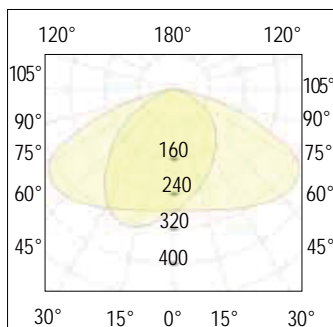

ST/CDL  
Stradale - Street optic

Ottiche a richiesta  
Optics on demand

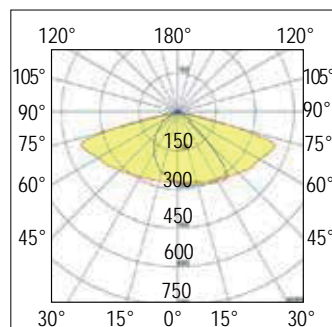

ST/CDL3  
Ottica stradale consigliata  
per piste ciclabili  
Street optic recommended  
for cycle paths

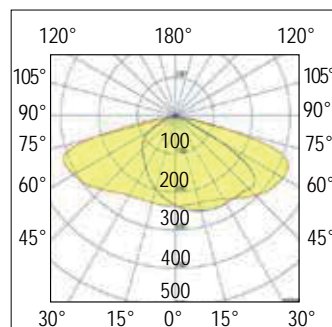

ST/CDL4  
Ottica consigliata per illumi-  
nazione stradale  
Optic recommended for  
street lighting

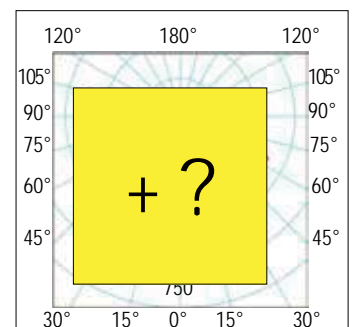

A richiesta è possibile fornire  
l'apparecchio con ottiche  
diverse da quelle già proposte  
On request, it is possible to  
supply the device with optics  
other than those already  
proposed

# LED Gran Sasso

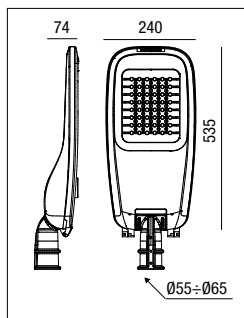

colour	W	Optic	K	nominal lm tc = 25°C	lm output	lm/W	pcs	Kg	CELL
N	60	ST	4000	11.200	9.900	165	1	3,60	346-60-4K
N	60	ST	3000	11.200	9.900	165	1	3,60	346-60-3K
N	75	ST	4000	13.900	12.400	165	1	3,60	346-75-4K
N	75	ST	3000	13.900	12.400	165	1	3,60	346-75-3K
N	90	ST	4000	16.800	14.850	165	1	3,60	346-90-4K
N	90	ST	3000	16.800	14.850	165	1	3,60	346-90-3K
N	120	ST	4000	22.300	19.800	165	1	4,50	347-120-4K
N	120	ST	3000	22.300	19.800	165	1	4,50	347-120-3K
N	140	ST	4000	26.100	23.100	165	1	5,00	347-140-4K
N	140	ST	3000	26.100	23.100	165	1	5,00	347-140-3K
DYNA	N	60	ST	4000	11.200	9.900	1	3,60	346-60-4K-DY
DYNA	N	60	ST	3000	11.200	9.900	1	3,60	346-60-3K-DY
DYNA	N	75	ST	4000	13.900	12.400	1	3,60	346-75-4K-DY
DYNA	N	75	ST	3000	13.900	12.400	1	3,60	346-75-3K-DY
DYNA	N	90	ST	4000	16.800	14.850	1	3,60	346-90-4K-DY
DYNA	N	90	ST	3000	16.800	14.850	1	3,60	346-90-3K-DY
DYNA	N	120	ST	4000	22.300	19.800	1	4,50	347-120-4K-DY
DYNA	N	120	ST	3000	22.300	19.800	1	4,50	347-120-3K-DY
DYNA	N	140	ST	4000	26.100	23.100	1	5,00	347-140-4K-DY
DYNA	N	140	ST	3000	26.100	23.100	1	5,00	347-140-3K-DY

Street furniture

Gestione del punto luce per un ulteriore risparmio di energia (richiedere preventivo) - *Management of the lighting point for further energy savings (Request a quotation)*

Regolazione 1÷10V <i>1÷10V control</i>	Mezzanotte virtuale <i>Virtual midnight</i>	Zhaga Socket	Telegestione sistema Wi-Fi <i>(da concordare) - Wi-Fi system remote management (to be agreed)</i>
Possibilità di regolazione 10% - 100% con sistema 1÷10V <i>Possibility of adjustment 10% - 100% with 1-10V system</i>	Sistema con riduzione automatica del flusso <i>System with automatic flux reduction</i>	Predisposizione sul corpo dell'apparecchio. Ideale per la gestione dell'illuminazione autonoma locale tramite sensori o da remoto. <i>For installation on the body of the appliance. Ideal for autonomous management of the lighting, either locally with sensors or remotely</i>	Sistema di controllo, gestione consumi e diagnosi dell'impianto con tecnologia Wi-Fi <i>Control system, consumption management and diagnosis of the system with Wi-Fi technology</i>



# LED Mini Gran Sasso - LED Gran Sasso

Gestione del punto luce per un ulteriore risparmio di energia (richiedere preventivo) - *Management of the lighting point for further energy savings (Request a quotation)*

Mezzanotte virtuale - *Virtual midnight*

Sistema con riduzione automatica del flusso - *System with automatic flux reduction*

## DYNA control - Mezzanotte virtuale - Virtual midnight

**DYNA**

Il settaggio del FLUSSO LUMINOSO avviene con programmazione della corrente di pilotaggio. Tale programmazione va richiesta in sede, durante la fase d'ordine / progetto.

*The LUMINOUS FLUX setting is done by programming the driving current. This programming must be requested on site, during the order / project phase*

DYNA CONTROL è un sistema automatico di controllo del flusso luminoso delle lampade. Il sistema entra in funzione alla prima accensione calcolando per 3 giorni i tempi di accensione, il quarto giorno il sistema in modo autonomo calcola la mezzanotte virtuale eseguendo una regolazione del flusso regolando la lampada come indicato sullo schema di Fig. 1; per i primi tre giorni quindi il sistema manterrà le lampade accese al 100%, nel tempo di accensione dell'impianto, il quarto giorno entrerà in funzione il sistema DYNA CONTROL gestendo in modo autonomo il flusso luminoso garantendo così un notevole risparmio energetico. Accensioni inferiori ad 1 ora (es. manutenzione) verranno ignorate ed il sistema non entra in funzione, per accensioni da 1 a 4 ore (es. anomalia impianto) o superiori alle 23 ore (es. impianto sempre acceso), il sistema resetta il timer quindi ricomincerà a contare per i primi 3 giorni e successivamente riprenderà il funzionamento automatico.

*DYNA CONTROL is an automatic system to control lamp brightness. The system starts working when first switched-on calculating switch-on times for 3 days, on the fourth day the system autonomously calculates the virtual midnight, adjusting the brightness of the lamp as indicated in fig.1. Therefore, for the first three days the system will keep the lamps on at 100%, during system switch-on, on the fourth day, the DYNA CONTROL system will start operating autonomously, controlling the lamp's brightness, thus ensuring significant energy savings.*

*Switch-on of less than 1 hour (ex. for maintenance) will be ignored and the system will not operate. For switch-on times from 1 to 4 hours (ex. system anomaly) or over 23 hours (ex. system always on), the system resets the timer and will restart counting for the first 3 days and then resume to automatic operation.*

Fig. 1 - Esempio applicativo 5 steps - *Application example 5 steps*

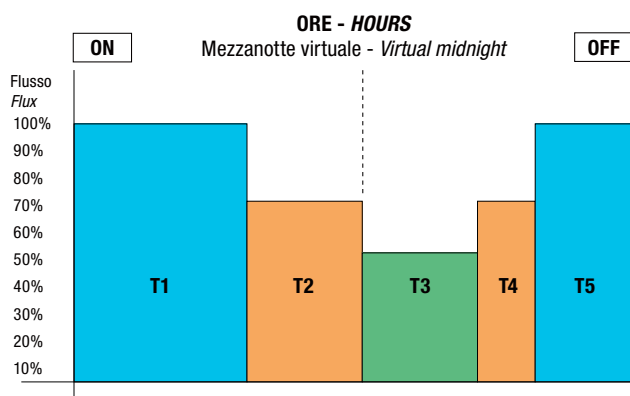

T1	= 30% "T" - 100% Flusso luminoso - Luminous flux
T2	= 20% "T" - 70% Flusso luminoso - Luminous flux
T3	= 20% "T" - 50% Flusso luminoso - Luminous flux
T4	= 10% "T" - 70% Flusso luminoso - Luminous flux
T5	= 20% "T" - 100% Flusso luminoso - Luminous flux

Minimo tempo di accensione per funzionamento automatico 4 ore (3 giorni).  
Accensioni di 1 ora ignorate.

Accensioni da 1 a 4 ore oppure superiori alle 23 ore resettano il sistema.

*The minimum ignition time for automatic operation is 4 hours (three days).  
Ignitions 1 hour ignored.*

*Switching from 1 to 4 hours or higher with 23 hours reset the system.*

### Accessori non inclusi - *Not included accessories*



Code: RO0640/N

#### PROTEZIONE ALLE SOVRATENSIONI

In un impianto elettrico standard un apparecchio a LED può essere sottoposto a sbalzi di tensione e disturbi esterni dovuti a fattori quali carichi discontinui sulla linea, guasti sulle linee a monte o a valle e, soprattutto, scariche atmosferiche (negli impianti esterni).

Nei nostri proiettori, dove l'elettronica è fondamentale, la resistenza alle sovratensioni è sinonimo di affidabilità e corretta funzionalità.

#### SURGE PROTECTOR

*In a standard electrical system an LED luminaire can be subjected to voltage fluctuations and external disturbances due to factors such as discontinuous loads on the line, faults on the lines upstream or downstream and, especially, atmospheric discharges (in External Plants).*

*In our projectors, where electronics is very important, the surge resistance is synonymous with reliability and proper functionality.*



Code: 220001236

Braccio a parete  
*Wall bracket*

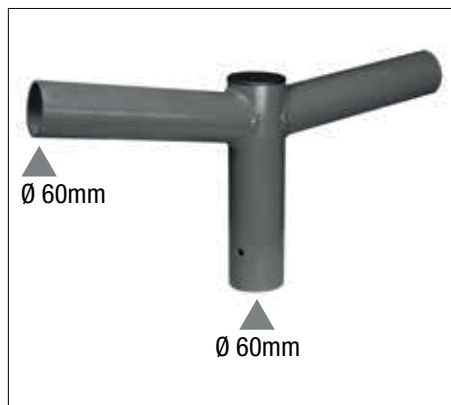

Cod. 802020.0101

Braccio 2X - *2X bracket*

#### ZHAGA SOCKET



- Connettore max 30Vdc - max 1,5A  
Connector max 30Vdc - max 1,5A  
**Code:** 488787561

- Tappo IP66 - Cap connector IP66  
**Code:** 488787581

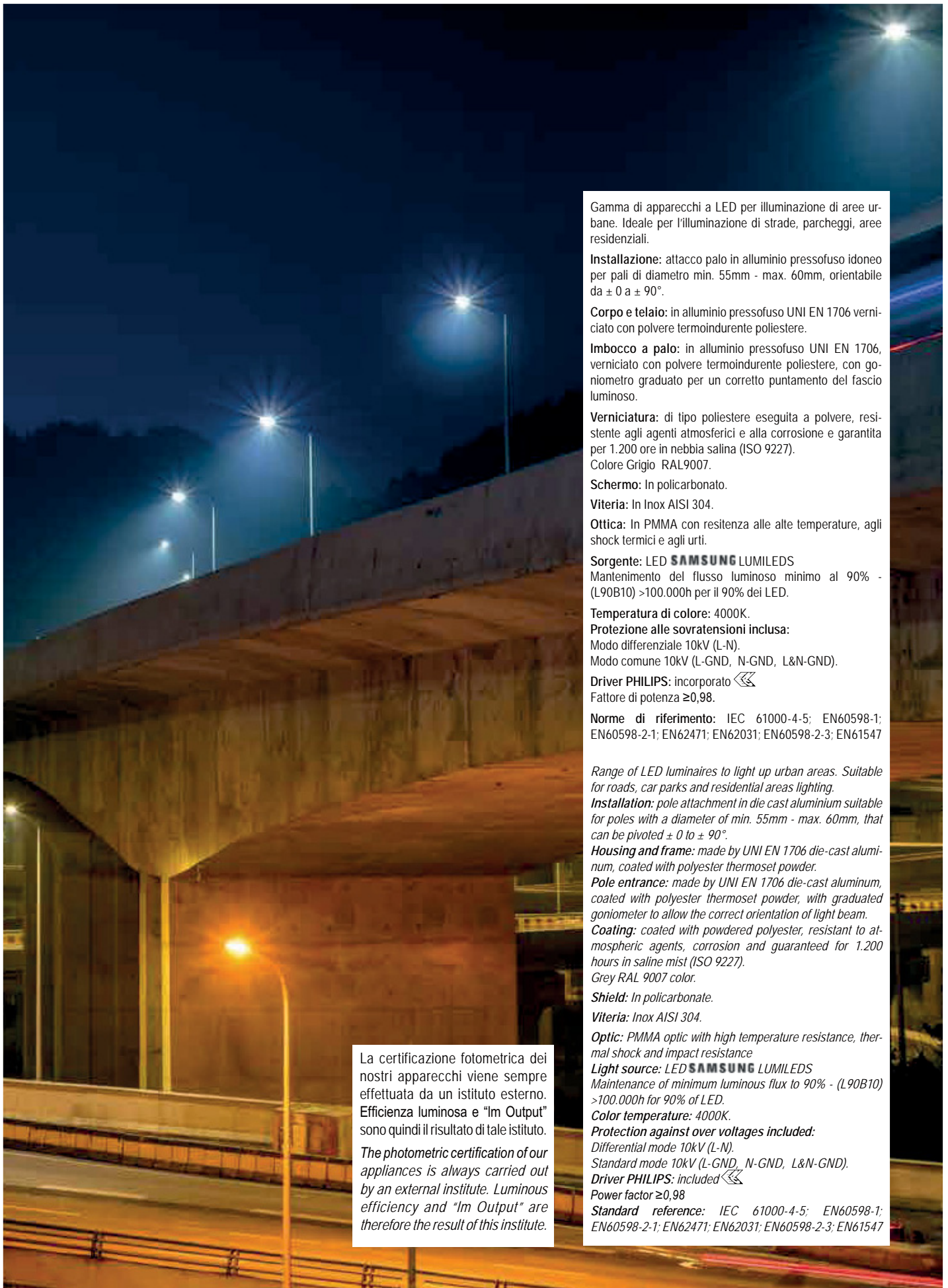

La certificazione fotometrica dei nostri apparecchi viene sempre effettuata da un istituto esterno. Efficienza luminosa e "lm Output" sono quindi il risultato di tale istituto.

*The photometric certification of our appliances is always carried out by an external institute. Luminous efficiency and "lm Output" are therefore the result of this institute.*

Gamma di apparecchi a LED per illuminazione di aree urbane. Ideale per l'illuminazione di strade, parcheggi, aree residenziali.

**Installazione:** attacco palo in alluminio pressofuso idoneo per pali di diametro min. 55mm - max. 60mm, orientabile da  $\pm 0$  a  $\pm 90^\circ$ .

**Corpo e telaio:** in alluminio pressofuso UNI EN 1706 verniciato con polvere termoindurente poliestere.

**Imbocco a palo:** in alluminio pressofuso UNI EN 1706, verniciato con polvere termoindurente poliestere, con goniometro graduato per un corretto puntamento del fascio luminoso.

**Verniciatura:** di tipo poliestere eseguita a polvere, resistente agli agenti atmosferici e alla corrosione e garantita per 1.200 ore in nebbia salina (ISO 9227). Colore Grigio RAL9007.

**Schermo:** In policarbonato.

**Viteria:** In Inox AISI 304.

**Ottica:** In PMMA con resistenza alle alte temperature, agli shock termici e agli urti.

**Sorgente:** LED **SAMSUNG** LUMILEDS  
 Mantenimento del flusso luminoso minimo al 90% - (L90B10) >100.000h per il 90% dei LED.

**Temperatura di colore:** 4000K.

**Protezione alle sovratensioni inclusa:**

Modo differenziale 10kV (L-N).

Modo comune 10kV (L-GND, N-GND, L&N-GND).

**Driver PHILIPS:** incorporato 

Fattore di potenza  $\geq 0,98$ .

**Norme di riferimento:** IEC 61000-4-5; EN60598-1; EN60598-2-1; EN62471; EN62031; EN60598-2-3; EN61547

*Range of LED luminaires to light up urban areas. Suitable for roads, car parks and residential areas lighting.*

**Installation:** pole attachment in die cast aluminium suitable for poles with a diameter of min. 55mm - max. 60mm, that can be pivoted  $\pm 0$  to  $\pm 90^\circ$ .

**Housing and frame:** made by UNI EN 1706 die-cast aluminium, coated with polyester thermoset powder.

**Pole entrance:** made by UNI EN 1706 die-cast aluminium, coated with polyester thermoset powder, with graduated goniometer to allow the correct orientation of light beam.

**Coating:** coated with powdered polyester, resistant to atmospheric agents, corrosion and guaranteed for 1.200 hours in saline mist (ISO 9227).

Grey RAL 9007 color.

**Shield:** In polycarbonate.

**Viteria:** In Inox AISI 304.

**Optic:** PMMA optic with high temperature resistance, thermal shock and impact resistance

**Light source:** LED **SAMSUNG** LUMILEDS  
 Maintenance of minimum luminous flux to 90% - (L90B10) >100.000h for 90% of LED.

**Color temperature:** 4000K.

**Protection against over voltages included:**

Differential mode 10kV (L-N).

Standard mode 10kV (L-GND, N-GND, L&N-GND).

**Driver PHILIPS:** included 

Power factor  $\geq 0,98$

**Standard reference:** IEC 61000-4-5; EN60598-1; EN60598-2-1; EN62471; EN62031; EN60598-2-3; EN61547

## LED Pordoi 100W - 150W

LED Pordoi 150W

LED Pordoi 100W



Apparecchio predisposto  
all'installazione su palo  
(Vedi Pag. 100)  
**Fixture designed for pole  
installation (See page 100)**

220-240  
Vac

50/60  
Hz

IP65

IK08

CRI  
> 70

+105  
C°  
-40

CE

RoHS

850°

850°

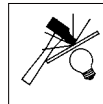

LOW  
FLICKER

RG0

DRIVER INCLUDED  
MULTIPOWER  
RIPPLE FREE

RoHS  
compliance



## LED Pordoi 100W

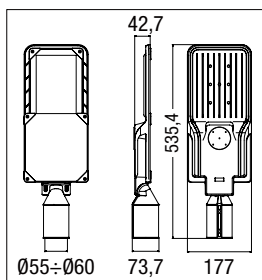

colour	W*	Optic	K	nominal lm tc = 25°C	lm output	lm/W	pcs	Kg	CELL
N	100	ST	4000	14.950	13.000	130	1	1,45	PORDOI1004K

\*A richiesta / on request

4000K 20W - 30W - 40W - 50W - 60W - 75W

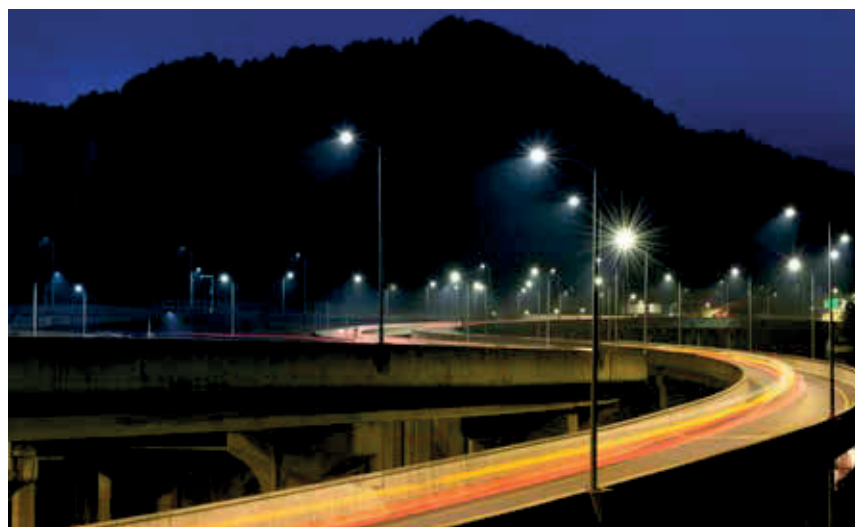

## LED Pordoi 150W

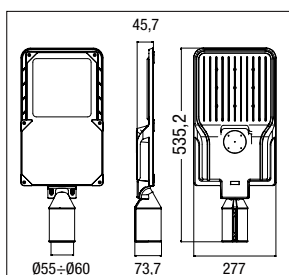

colour	W	Optic	K	nominal lm tc = 25°C	lm output	lm/W	pcs	Kg	CELL
N	150	ST	4000	22.425	19.500	130	1	1,85	PORDOI1504K

\*A richiesta / on request

4000K 120W - 130W - 140W

Staffa per applicazione a parete a richiesta  
Bracket for wall application on demand

Code: 220001236  
Grigio RAL 9007  
Grey RAL 9007



Ottica di serie  
Standard optic

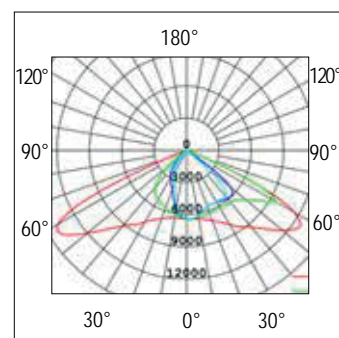

ST/CDL  
Stradale - Street optic

# LED Folgore

Outdoor



18 m				
12 m				
8 m				
4 m				

30W      75W      100W      RGBW

Apparecchio lineare disponibile in 3 lunghezze con luce LED monocromatica bianca, con 4 opzioni ottiche, ideale per illuminazione a parete, garantisce prestazioni eccezionali e la massima flessibilità per ogni soluzione di progettazione illuminotecnica, ideale per l'illuminazione di piazze, edifici, sculture, insegne e cartelloni pubblicitari. Supporto a parete e soffitto, con bracci orientabili.

Viti esterne in acciaio inox 304.

**Installazione:** su superfici verticali e orizzontali (completo di staffa di fissaggio).

**Corpo:** in alluminio estruso e testata terminale a filo in pressofusione con vetro temperato super bianco, ad elevato comfort visivo e distribuzione uniforme della luce.

**Dispositivo anticondensa:** valvola di compensazione e riciclo dell'aria.

**Ottiche:** scelta tra 4 ottiche disponibili, accessorio non incluso ottica honey-comb per un migliore comfort visivo, evita inutili abbagliamenti e riduce l'inquinamento luminoso.

**Verniciatura:** verniciatura superficiale a polvere di poliestere puro anti-ultravioletti. Resistenza alla corrosione superiore a 1000 ore.

**Staffa di fissaggio:** in alluminio, verniciata con polvere termoindurente poliestere.

**Guarnizione:** completa di guarnizioni in silicone dalle rilevanti prestazioni meccaniche ed elastiche

**Sorgente:** LUMILEDS 3528 Mantenimento del flusso luminoso minimo al 80% - 50.000h (L80B10) per il 90% dei LED.

**Temperatura di colore:** 3000K, a richiesta 2700K 4000K e RGB.

**Cablaggio:** 1,5m di cavo tipo H07RN-F 2x1mm<sup>2</sup>

**Norme di riferimento:** EN60598-1; EN60598-2-1; EN62471; EN62031; EN61547

**Driver:** incorporato  $\llcorner$  Fattore di potenza  $\geq 0,95$

*Linear fixture available in 3 lengths with white monochromatic LED light, with 4 optical options, ideal for wall lighting. It guarantees exceptional performance and maximum flexibility for any lighting design solution. It is ideal for illuminating squares, buildings, sculptures, signs, and billboards. Wall and ceiling mount with adjustable arms.*

*304 stainless steel external screws.*

*Installation: on vertical and horizontal surfaces (complete with mounting bracket).*

*Body: extruded aluminum and die-cast flush end cap with super-white tempered glass, for high visual comfort and uniform light distribution.*

*Anti-condensation device: compensation valve and air recycling.*

*Optics: choice of 4 available optics; honeycomb optic accessory not included for improved visual comfort, avoids unnecessary glare, and reduces light pollution.*

*Coating: pure ultraviolet-resistant polyester powder coating. Corrosion resistance greater than 1,000 hours.*

*Mounting bracket: aluminum, coated with thermosetting polyester powder.*

*Gasket: Complete with silicone gaskets with high mechanical and elastic performance*

*Light source: LUMILEDS 3528 Minimum luminous flux maintenance at 80% - 50,000h (L80B10) for 90% of the LEDs.*

*Color temperature: 3000K, 2700K, 4000K and RGB available upon request.*

*Wiring: 1.5m of H07RN-F 2x1mm<sup>2</sup> cable*

**Reference standards:** EN60598-1; EN60598-2-1; EN62471; EN62031; EN61547

**Driver:** Built-in Power factor  $\geq 0,95$

Misure disponibili - sizes available



L. 570mm.



L. 1060mm.



L. 1545mm.



Outdoor

220-240 Vac	110 Vac On demand	50/60 Hz	IP66	IK09	CRI 80	+40 C -20	850°	CE		
	Driver included									

## LED Folgore

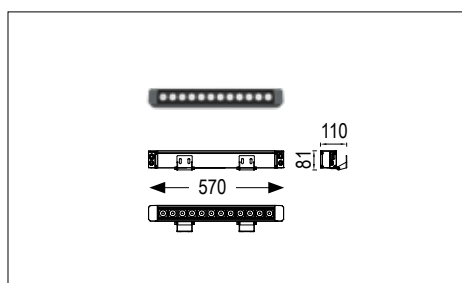
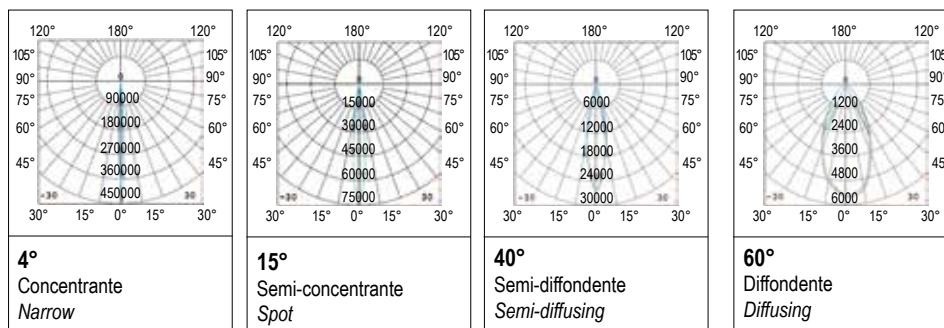

LED Folgore 30W									
	colour	W	angle	K	nominal lm tc = 25°C	lm output	pcs	Kg	CELL
	B	30	4°	3000	2820	2250	1	2,75	57-30-4-4K
	B	30	15°	3000	2820	2250	1	2,75	57-30-15-4K
	B	30	40°	3000	2820	2250	1	2,75	57-30-40-4K
	B	30	60°	3000	2820	2250	1	2,75	57-30-60-4K

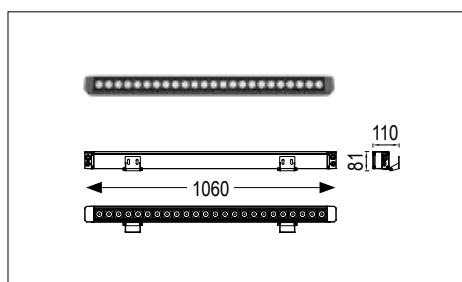

LED Folgore 75W									
	colour	W	angle	K	nominal lm tc = 25°C	lm output	pcs	Kg	CELL
	B	75	4°	3000	6480	5400	1	5	106-75-4-4K
	B	75	15°	3000	6480	5400	1	5	106-75-15-4K
	B	75	40°	3000	6480	5400	1	5	106-75-40-4K
	B	75	60°	3000	6480	5400	1	5	106-75-60-4K

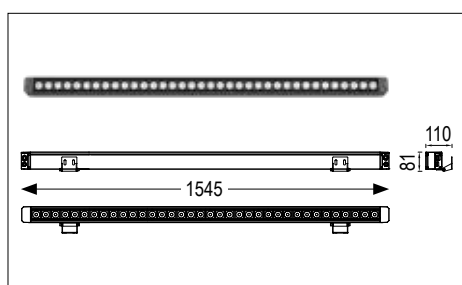

LED Folgore 100W									
	colour	W	angle	K	nominal lm tc = 25°C	lm output	pcs	Kg	CELL
	B	100	4°	3000	9250	7400	1	8	154-100-4-4K
	B	100	15°	3000	9250	7400	1	8	154-100-15-4K
	B	100	40°	3000	9250	7400	1	8	154-100-40-4K
	B	100	60°	3000	9250	7400	1	8	154-100-60-4K

A richiesta: per quantità minima 100 pezzi a 2700K - 4000K - RGB  
 On demand: for minimum quantity 100 pieces at 2700K - 4000K - RGB

### Filtro a richiesta - Filter on request

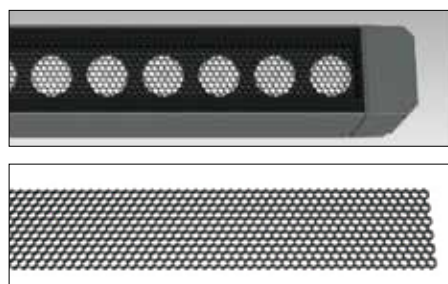

Cod. FOLHONEY  
 Filtro a nido d'ape.  
 Honeycomb louvre.

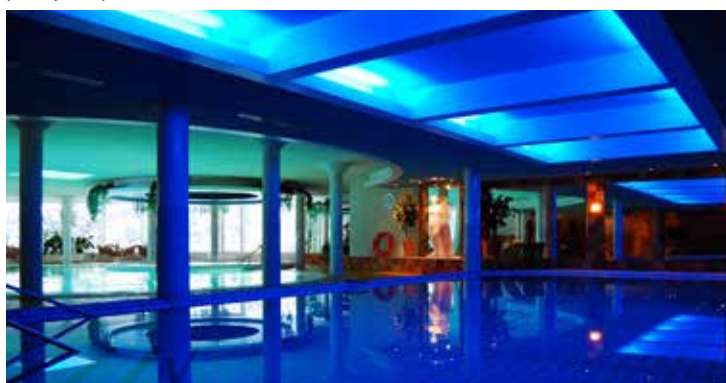

**Cablaggio in linea continua - Continuous line wiring**

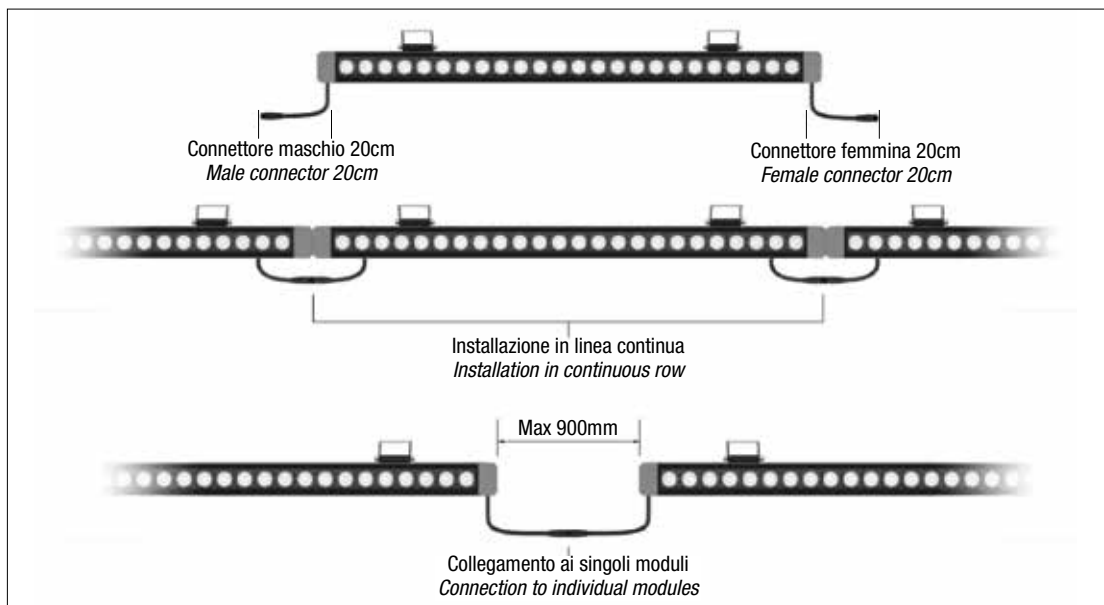

Possibilità di montaggio in linea continua utilizzando i due cavi completi di connettore ad innesto rapido (maschio/femmina) di lunghezza 200mm.

Durante l'installazione di singoli moduli, la distanza tra loro può essere aumentata utilizzando accessori speciali (cavo multipolare e connettori).

*Continuous line installation possible using the two cables complete with quick-connect connectors (male/female) 200mm. long.*

*When installing individual modules, the distance between them can be increased using special accessories (multi-core cable and connectors).*



**Cod. RE320000543**  
Connettore femmina rapido L.300mm.  
*Quick Female Connector L.300mm.*



**Cod. RE32000054 2**  
Connettore maschio rapido L.300mm.  
*Quick Male Connector L.300mm.*

**Scatola di derivazione IP67 per cablaggio in linea continua - IP67 junction box for continuous line wiring**

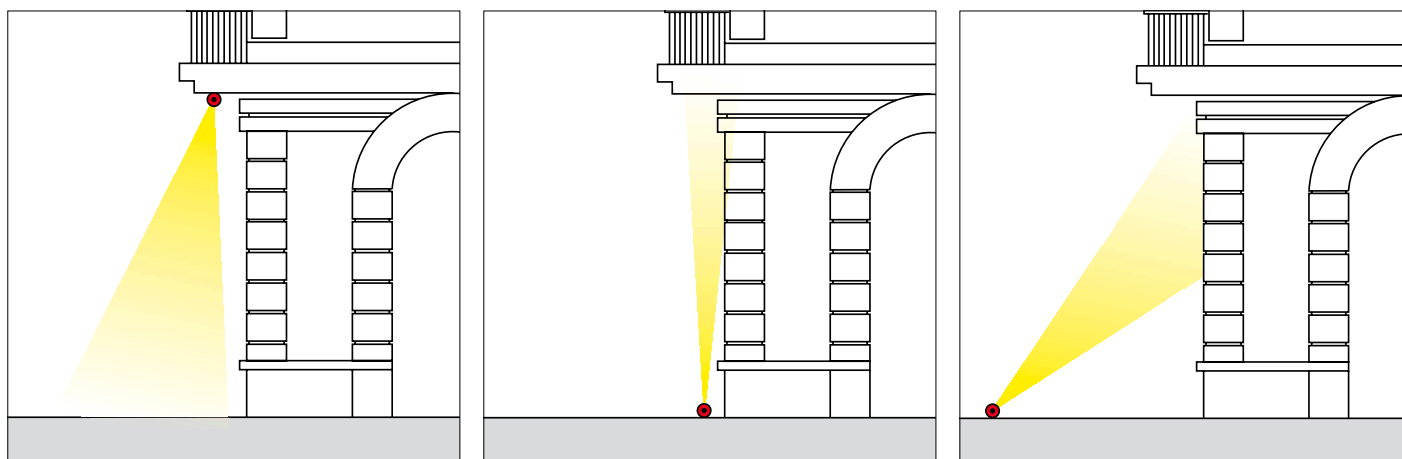

**Cod. XPG9-P104**  
Accessorio IP67 per linee di luce continua  
IP67 accessory for continuous light lines.



**Cod. XYPG9-IKP67**  
Accessorio IP68 per linee di luce continua  
IP68 accessory for continuous light lines.

# LED Monza round

Outdoor



Sistema LED lineare per applicazioni professionali nell'illuminazione di facciate, portici, sottopassaggi e in generale per l'illuminazione di particolari elementi architettonici. A richiesta è possibile collegare gli apparecchi in serie per ottenere delle linee di luce continua.

**Installazione:** su superfici verticali e orizzontali (completo di staffa di fissaggio).

**Corpo:** in policarbonato trasparente, resistente agli urti.

**Testate di chiusura:** in PVC, colore nero

**Staffa di fissaggio:** in alluminio, verniciata con polvere termoindurente poliestere

**Guarnizione:** in gomma ai siliconi dalle rilevanti prestazioni meccaniche ed elastiche

**Dispositivo anticondensa:** valvola di compensazione e riciclo dell'aria

**Norme di riferimento**

EN60598-1; EN60598-2-1; EN62471; EN62031; EN61547

**Sorgente:** LUMILEDS 3528

Mantenimento del flusso luminoso minimo al 80% - 50.000h (L80B10) per il 90% dei LED.

**Temperatura di colore:** 2200K, 3000K e 4000K

**Cablaggio:** 1,5m di cavo tipo H07RN-F 2x1mm<sup>2</sup>

**Driver:** incorporato  Fattore di potenza ≥0,95

*LED linear system for professional lighting applications on facades, arcades, tunnels and generally to light up particular architectural elements. On demand it is possible to make a serial connection of the luminaires to have continuous light lines. The very low energy consumption and a lifespan exceeding 30.000 hours make the profiles ideal both for installations in new electrical systems and replacement of luminaires with traditional light sources.*

**Installation:** on vertical and horizontal surfaces (complete with fixing bracket)

**Housing:** made by transparent polycarbonate, resistant to collisions

**End caps:** made by PVC, black color

**Fixing bracket:** made by aluminum, coated with polyester thermoset powder

**Gasket:** made by silicone rubber with high mechanical and elastic performance

**Anti-condensate device:** valve for compensation and circulation of air

**Standard reference**

EN60598-1; EN60598-2-1; EN62471; EN62031; EN61547

**Light source:** LUMILEDS 3528

Maintenance of 80% minimum luminous flux: 50,000h (L80B10) for 90% of the LEDs.

**Color temperature:** 2200K, 3000K and 4000K

**Wiring:** 1,5m cable type H07RN-F 2x1mm<sup>2</sup>

**Driver:** included  Power factor ≥0,95

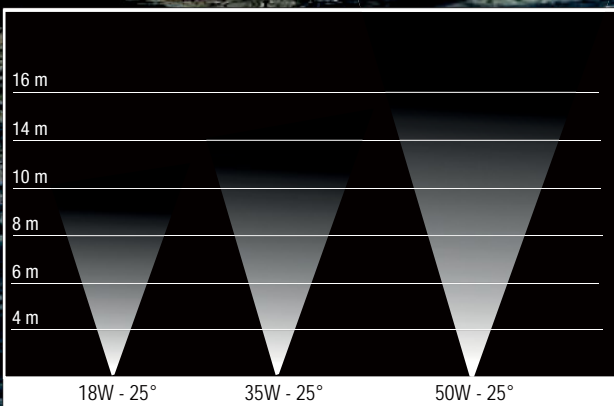

A richiesta  
On demand

1-10Vdc

Pag. VI



Pag. VI

220-240 Vac	110 Vac On demand	50/60 Hz	IP67	IK09	CRI 90	+40 C° -20	850°	CE		
Driver included 		DIM a richiesta on demand 								

## LED Monza round

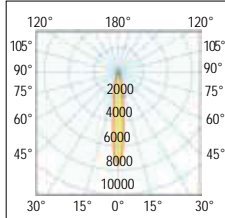

**10°**  
Concentrante - *Narrow*  
Schermo trasparente  
standard - *Standard*  
transparent shield

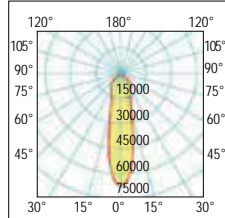

**25°**  
Semi-concentrante - *Spot*  
Schermo trasparente  
standard - *Standard*  
transparent shield



### LED Monza round 70 Wall Washer

colour	W	angle	K	nominal lm tc = 25°C	lm output	lm/W	pcs	Kg	CELL
T	18	10°	3000	2600	2160	120	1	0,92	27334/R/10/3K
T	18	10°	4000	2600	2160	120	1	0,92	27334/R/10
T	18	25°	3000	2600	2160	120	1	0,92	27334/R/3K
T	18	25°	4000	2600	2160	120	1	0,92	27334/R

A richiesta: per quantità minima 100 pezzi disponibili a 2200K - *On demand: for quantity min 100 pcs available 2200K*

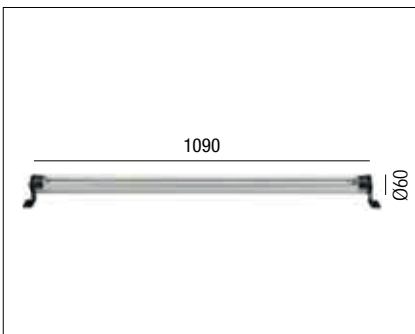

### LED Monza round 100

colour	W	angle	K	nominal lm tc = 25°C	lm output	lm/W	pcs	Kg	CELL
T	35	10°	3000	5040	4200	120	1	1,20	27339/R/10/3K
T	35	10°	4000	5040	4200	120	1	1,20	27339/R/10
T	35	10°	4000	5040	4200	120	1	1,20	27339/R/10/DA
T	35	25°	3000	5040	4200	120	1	1,20	27333/R/3K
T	35	25°	4000	5040	4200	120	1	1,20	27333/R
T	50	10°	4000	6300	5500	110	1	1,20	27339/R/10/50
T	50	25°	4000	6300	5500	110	1	1,20	27339/R/25/50

A richiesta: per quantità minima 100 pezzi disponibili a 2200K - *On demand: for quantity min 100 pcs available 2200K*

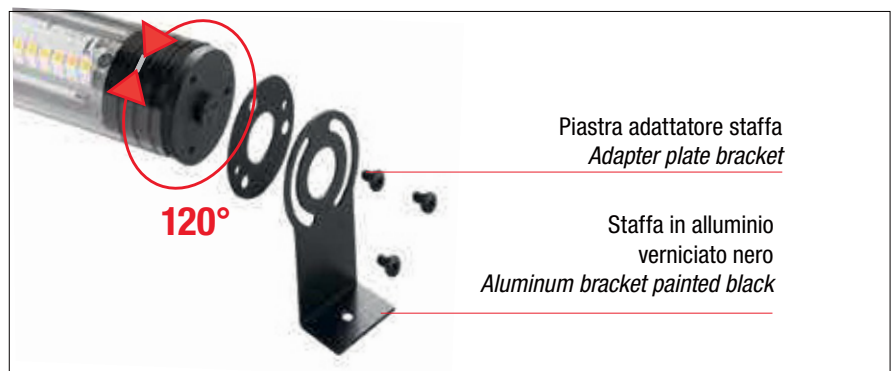

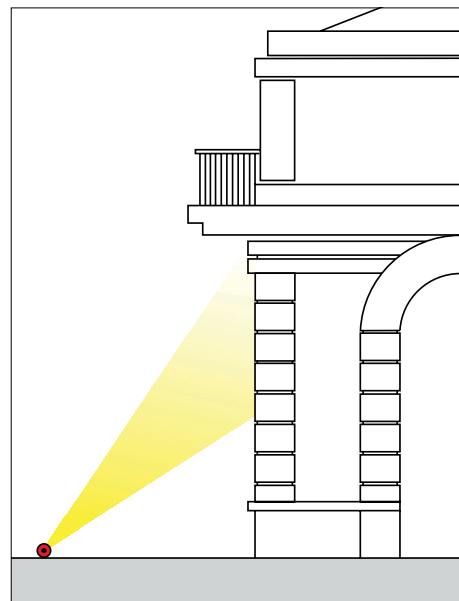
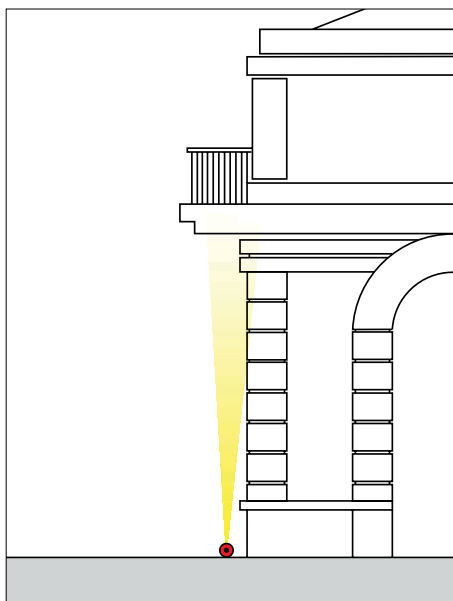
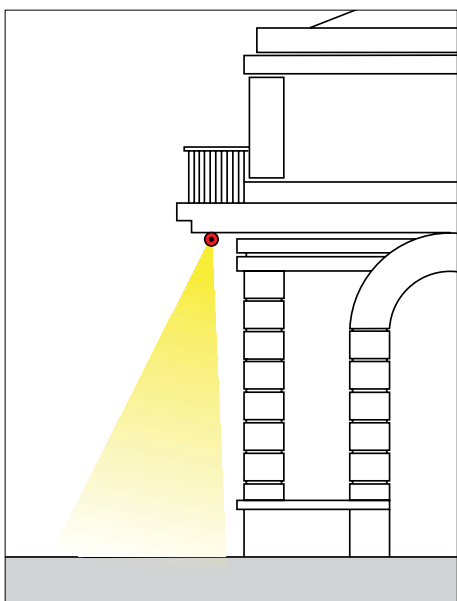

Accessori non inclusi - *Not included accessories*



IP67

Cod. XPG9-P104  
 Accessorio IP67 per linee di luce continua  
 IP67 accessory for continuous light lines.



IP67

Cod. XYPG9-IKP67  
 Accessorio IP68 per linee di luce continua  
 IP68 accessory for continuous light lines.

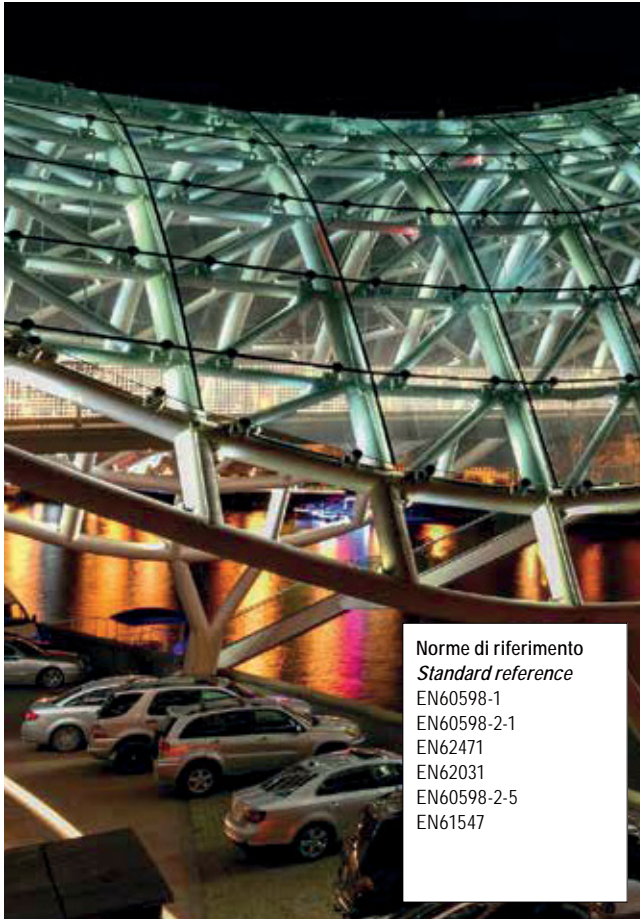

Norme di riferimento  
Standard reference  
EN60598-1  
EN60598-2-1  
EN62471  
EN62031  
EN60598-2-5  
EN61547

Sistema LED lineare per applicazioni professionali nell'illuminazione di facciate, portici e in generale per l'illuminazione di particolari elementi architettonici.

**Installazione:** su superfici verticali e orizzontali (completo di staffa di fissaggio) e a sospensione.

**Corpo:** in policarbonato opale parte inferiore (luminosa) Grigio parte superiore.

**Testate di chiusura:** in acciaio Inox

**Staffa di fissaggio:** in acciaio Inox

**Guarnizione:** in gomma ai siliconi dalle rilevanti prestazioni meccaniche ed elastiche

**Dispositivo anticondensa:** valvola di compensazione e riciclo dell'aria

**Sorgente:** LUMILEDS

Mantenimento del flusso luminoso minimo al 80% - 50.000h (L80B10) per il 90% dei LED.

**Temperatura di colore:** 3000K o 4000K (a richiesta 2700K o 5000K);

**Cablaggio:** Standard 1.250cm di cavo tipo H07RN-F 2x1mm<sup>2</sup> (a richiesta lunghezze diverse)

**Driver:** incorporato . Fattore di potenza ≥0,95

*LED linear system for professional lighting applications on facades, arcades, tunnels and generally to light up particular architectural elements.*

***Installation:** on vertical and horizontal surfaces (complete with fixing bracket) and suspended.*

***Body:** opal polycarbonate lower part (luminous) Grey upper part.*

***End caps:** made in Inox steel*

***Fixing bracket:** made in Inox steel*

***Gasket:** made by silicone rubber with high mechanical and elastic performance*

***Anti-condensate device:** valve for compensation and circulation of air*

***Light source:** LUMILEDS*

*Maintenance of 80% minimum luminous flux: 50,000h (L80B10) for 90% of the LEDs.*

***Color temperature:** 3000K or 4000K (on demand 2700K or 5000K);*

***Wiring:** 1.250cm cable type H07RN-F 2x1mm<sup>2</sup> (different lengths on request)*

***Driver:** included . Power factor ≥0,95*

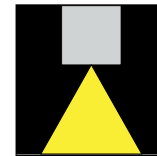
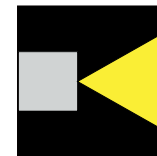
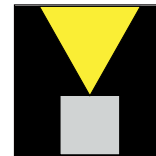
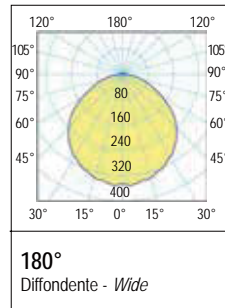

220-240  
Vac

50/60  
Hz

IP67

IK09

CRI  
90



850°



## CW su superfici verticali e orizzontale accessori montaggio inclusi On vertical and horizontal surfaces accessories included

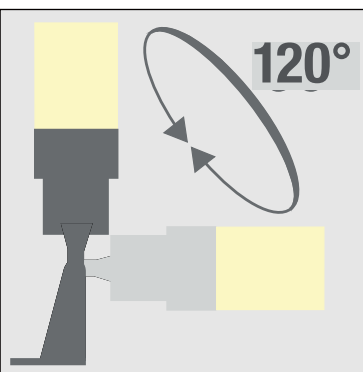
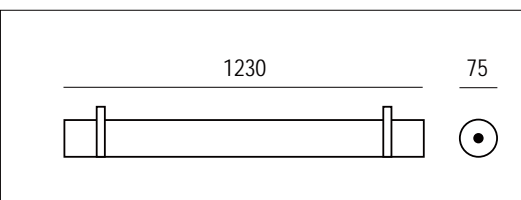

colour	W *	angle	K	nominal Im tc = 25°C	Im output	lm/W	pcs	Kg	CELL
OP	50	180°	3000	5.000	6.500	130	1	2,00	27339/TU/OP3K
OP	50	180°	3000	5.000	6.500	130	1	2,00	27339/TU/3KDA
OP	50	180°	4000	5.000	6.500	130	1	2,00	27339/TUBA/OP
OP	50	180°	4000	5.000	6.500	130	1	2,00	27339/TU/4KDA

## S sospensione con accessori montaggio inclusi Suspension with mounting accessories included

colour	W *	angle	K	nominal Im tc = 25°C	Im output	lm/W	pcs	Kg	CELL
OP	50	180°	3000	5.000	6.500	130	1	2,00	27340/TU/OP3K
OP	50	180°	3000	5.000	6.500	130	1	2,00	27340/TU/3KDA
OP	50	180°	4000	5.000	6.500	130	1	2,00	27340/TUBA/OP
OP	50	180°	4000	5.000	6.500	130	1	2,00	27340/TU/4KDA

w \* = A richiesta/on demand 20W (2600lm) - 30W (3900lm) - 40W (5200lm).



## LED Tuba Lux S



Outdoor

A richiesta cablaggio con linea passante  
Trough-wiring cabling on request



Cavo in uscita e in entrata di lunghezze diverse a richiesta  
Output and input cable of different lengths on request

# LED Positano

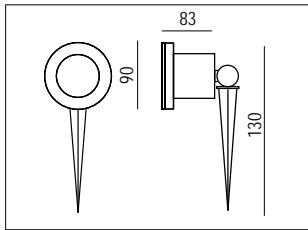

**Norme di riferimento**  
**Standard reference**  
 EN60598-1  
 EN60598-2-1  
 EN62471  
 EN62031  
 EN60598-2-5  
 EN61547

Faretto ad illuminazione d'accento concepito per l'illuminazione di aree esterne. Costituisce uno strumento efficace per l'illuminazione di arredi, percorsi, porticati ed altri elementi architettonici, ma anche gruppi di vegetazione come alberi e cespugli.

**Corpo:** materiale termoplastico (Positano), alluminio pressofuso (Gargano)

**Schermo:** vetro temprato resistente agli shock termici e agli urti

**Cablaggio:** completo di cavo 3m (VDE H05RR-F - 2x1mm<sup>2</sup>) e spina Schuko

**Sorgente:** lampadina LED GU10 (Positano), LED SMD (Gargano)

**Accessori inclusi:** picchetto, staffa di fissaggio a parete e lampadina (solo per Positano)

**Ghiera Gargano:** alluminio. Verniciatura di tipo poliesteri eseguita a polvere resistente agli agenti atmosferici e alla nebbia salina.

*Spot-light with accentuated lighting for use in indoor or outdoor where a high degree IP protection is required.*

*It is an efficient means of lighting objects, parths, porches and other architectural features, as well as vegetation such a trees and shrubs.*

**Housing:** thermoplastic material

**Shield:** tempered glass resistant against thermal shocks and collision

**Wiring:** complete with 3m wire (VDE H05RR-F - 2x1mm<sup>2</sup>) and schuko plug

**Source:** GU10 LED lamp

**Included accessories:** spike, wall fitting bracket and lamp (uniquement pour Positano)

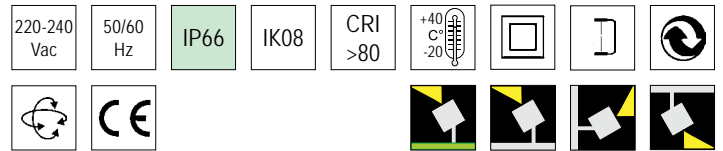

colour	W	LED	K	lm	pcs	Kg	S + L
<b>N</b>	6	Led GU10 lamp	4000	450	1	0,80	02012/LEDGU10
<b>N</b>	6	Led GU10 lamp	3000	450	1	0,80	02013/LEDGU10



# LED Capri - LED Capri Mini



LED Capri è un apparecchio da esterno, ad alto grado di protezione, utilizzabile sia tramite staffa di fissaggio da terra o parete (inclusa) che con picchetto (da ordinare separatamente), ideale per illuminare facciate giardini, parchi, aiuole, terrazzi.

**Corpo e telaio:** in alluminio pressofuso UNI EN 1706 verniciato con polvere termoidurente poliestere

**Staffa di fissaggio:** in acciaio, verniciata con polvere termoidurente poliestere

**Verniciatura:** di tipo poliestere eseguita a polvere, resistente agli agenti atmosferici e alla corrosione e garantita per 1.000 ore in nebbia salina. Colore Nero RAL 9005.

**Schermo:** vetro temprato di spessore 4mm resistente agli shock termici e agli urti.

**Driver:** incorporato

**Sorgente:** LED **CREE** Fattore di potenza  $\geq 0,92$ . Mantenimento del flusso luminoso al 80%. 50.000h (L80B20).

*The Capri LED is an outdoor appliance with a high degree of protection, which can also be used with a floor or wall fixing bracket (included) or with a stake (to be ordered separately), ideal for illuminating façades in gardens, parks, flowerbeds, terraces.*

**Housing and frame:** made by UNI EN 1706 die-cast aluminum, coated with polyester thermoset powder

**Fixing bracket:** made by stainless steel, coated with polyester thermoset powder

**Coating:** coated with powdered polyester, resistant to atmospheric agents, corrosion and guaranteed for 1.000 hours in saline mist. Black RAL9005 color.

**Optic:** clumping

**Shield:** tempered glass with 4mm thickness resistant to thermal shocks and collisions

**Driver:** included

**Light source:** LED **CREE** Power factor  $\geq 0,92$ . maintenance of 80% minimum luminous flux: 50,000h (L80B20).

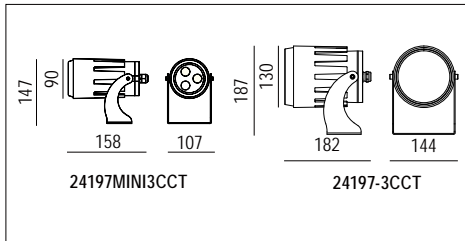

**Norme di riferimento  
Standard reference**  
EN60598-1  
EN60598-2-1  
EN62471  
EN62031  
EN60598-2-5  
EN61547

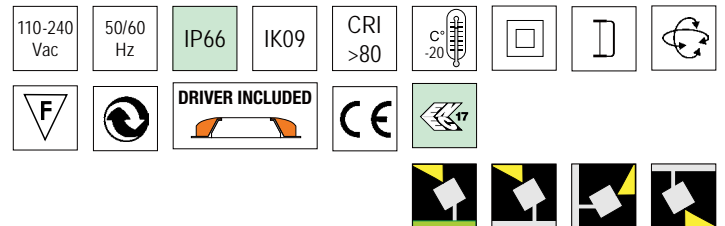

colour	W	Optic	K			lm	pcs	Kg	CELL
<b>N</b>	9	30°	2700	3000	4000	710	1	1,30	24197MINI3CCT
<b>N</b>	27	30°	2700	3000	4000	2230	1	1,60	24197-3CCT

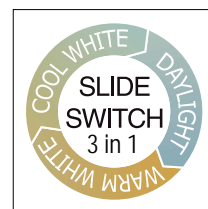

Funzione 3 CCT (2700K - 3000K - 4000K) modificabile con interruttore a cursore  
*Slide switch 3 CCT (2700K - 3000K - 4000K) changeable function*

**Accessori non inclusi  
Not included accessories**



Cod. 24165  
Picchetto in alluminio  
**ACCESSORIO  
NON INCLUSO  
NOT INCLUDED  
ACCESSORY  
aluminium spike**

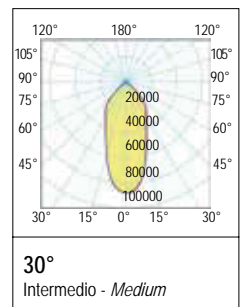

Outdoor

# LED Capri - LED Capri Mini



Outdoor

## LED Ischia

Outdoor



LED Ischia è un apparecchio da esterno, ad alto grado di protezione, utilizzabile sia tramite staffa di fissaggio da terra o parete (inclusa), con picchetto (da ordinare separatamente) o da palo (da ordinare separatamente), ideale per illuminare facciate giardini, parchi, aiuole, terrazzi.

**Corpo e telaio:** in alluminio pressofuso UNI EN 1706 verniciato con polvere termoindurente poliesteri

**Verniciatura:** di tipo poliesteri eseguita a polvere, resistente agli agenti atmosferici e alla corrosione e garantita per 1.000 ore in nebbia salina. Colore Nero RAL 9005.

**Ottica:** con lenti in PC ad alto confort visivo e buon effetto antiriflesso.

**Schermo:** vetro temprato di spessore 4mm super bianco resistente agli shock termici e agli urti.

**Driver:** incorporato

**Sorgente:** LED Fattore di potenza  $\geq 0,92$ . Mantenimento del flusso luminoso al 80%. 50.000h (L80B20)

A richiesta: **DALI 2** e DMX.

**Nome di riferimento:** EN60598-1; EN60598-2-1; EN62471; EN62031; EN60598-2-5; EN61547

*The Capri LED is an outdoor appliance with a high degree of protection, which can also be used with a floor or wall fixing bracket (included) or with a stake (to be ordered separately), ideal for illuminating façades in gardens, parks, flowerbeds, terraces.*

**Housing and frame:** made by UNI EN 1706 die-cast aluminum, coated with polyester thermoset powder

**Coating:** coated with powdered polyester, resistant to atmospheric agents, corrosion and guaranteed for 1.000 hours in saline mist. Black RAL9005 color.

**Optic:** with PC lenses with high visual comfort and good anti glare effect

**Shield:** tempered glass with 4mm thickness super white resistant to thermal shocks and collisions

**Driver:** included

**Light source:** LED Power factor  $\geq 0,92$ . maintenance of 80% minimum luminous flux: 50,000h (L80B20).

On demand: **DALI 2** and DMX.

**Standard reference:** EN60598-1; EN60598-2-1; EN62471; EN62031; EN60598-2-5; EN61547

100-240 Vac	50/60 Hz	IP66	IK09	CRI > 80	+40 C° -20			CE			
		Driver included <b> RIPPLE FREE </b>									

## LED Ischia 1

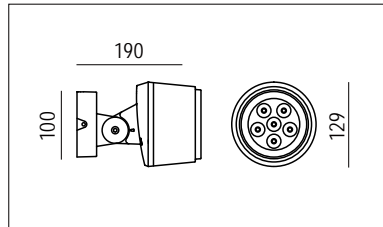

**Orientabilità**  
inclinazione del corpo  
lampada ± 90°  
**Adjustability**  
inclination of the lamp  
body ± 90°

colour	W	Optic	K	Lm/W	lm Output	pcs	Kg	CELL
<b>N</b>	18	40°	3000	144	2.600	1	1,80	215-18-40-3K
<b>N</b>	18	40°	2200	130	2.400	1	1,80	215-18-40-2K
<b>N</b>	18	40°	4000	144	2.600	1	1,80	215-18-40-4K

colour	W	Optic	K			Lm/W	lm Output	pcs	Kg	CELL
<b>N</b>	18	40°	2700	3000	4000	144	2.600	1	1,80	215-18-40-3C

**3CCT**  
SWITCHABLE

## LED Ischia 2

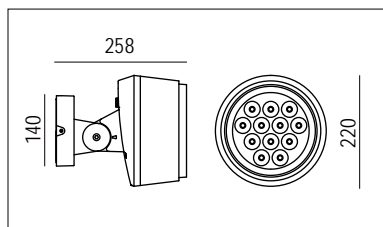

**Orientabilità**  
inclinazione del corpo  
lampada ± 90°  
**Adjustability**  
inclination of the lamp  
body ± 90°

colour	W	Optic	K	Lm/W	lm Output	pcs	Kg	CELL
<b>N</b>	40	40°	3000	130	5200	1	3,80	215-40-40-3K
<b>N</b>	40	40°	2200	130	4800	1	3,80	215-40-40-2K
<b>N</b>	40	40°	4000	130	5200	1	3,80	215-40-40-4K

### Dettaglio ottiche - Optical detail

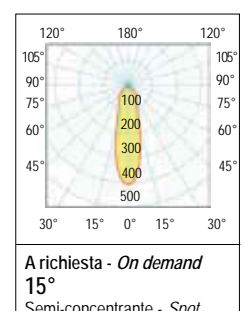
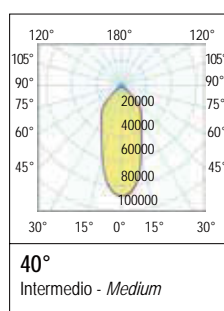

## LED Ischia



Outdoor

## LED Ischia accessorio per installazione su palo - *pole installation accessory*

Accessori non inclusi LED ISCHIA 40W - *Not included accessories LED ISCHIA 40W*



colour	Descrizione - Description	Code
<b>N</b>	Gancio singolo per applicazione su palo Ø 120 mm per LED Ischia 40W <i>Single Bracket for pole application Ø 120 mm LED Ischia 40W</i>	TG-215-A
<b>N</b>	Gancio doppio per applicazione su palo Ø 120 mm per LED Ischia 40W <i>Double Bracket for pole application Ø 120 mm LED Ischia 40W</i>	TG-215-B

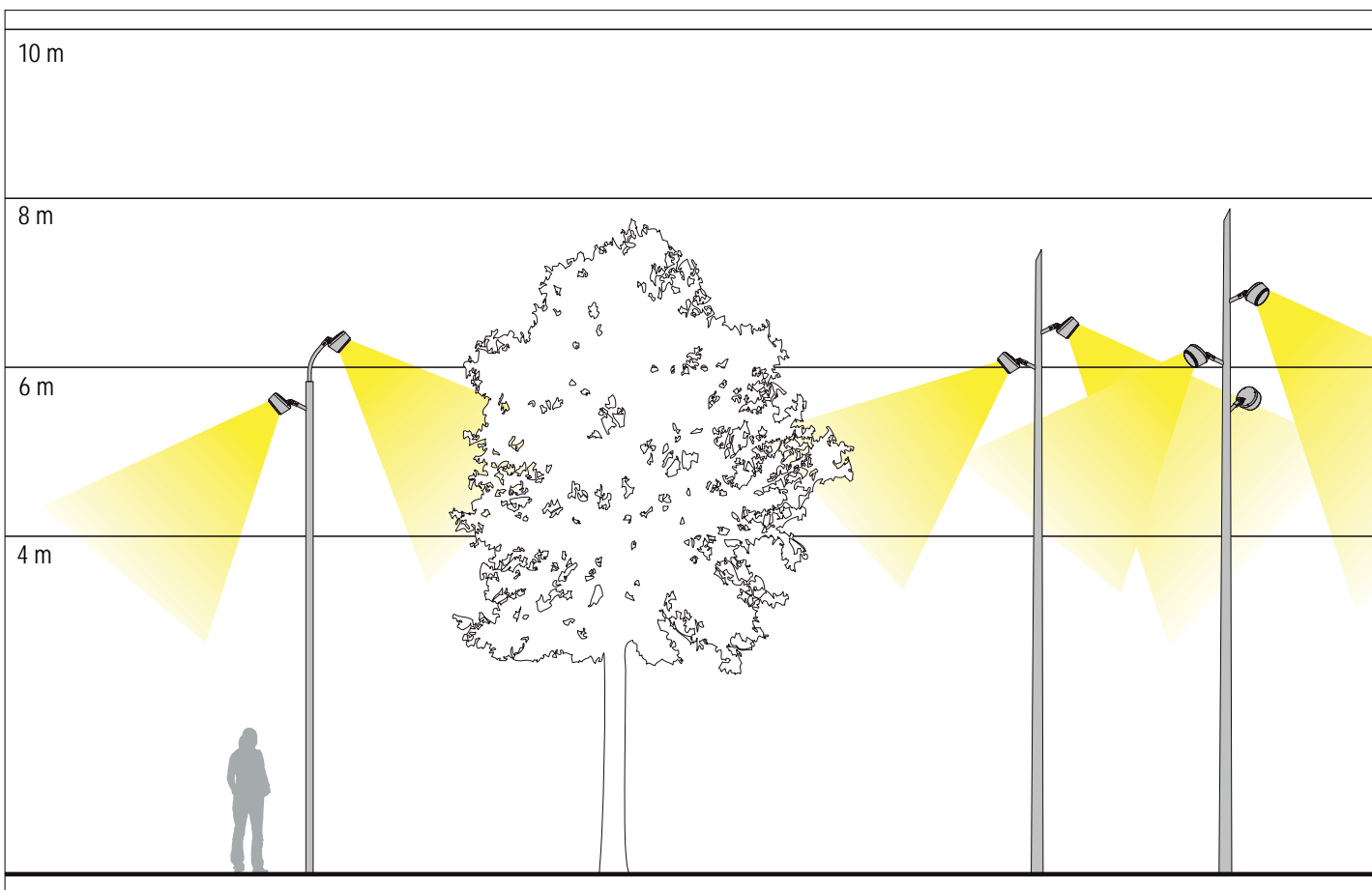

Outdoor

# LED Ischia accessorio per installazione con palo/picchetto - *accessory for installation with pole/spike*

Accessori non inclusi - *Not included accessories*

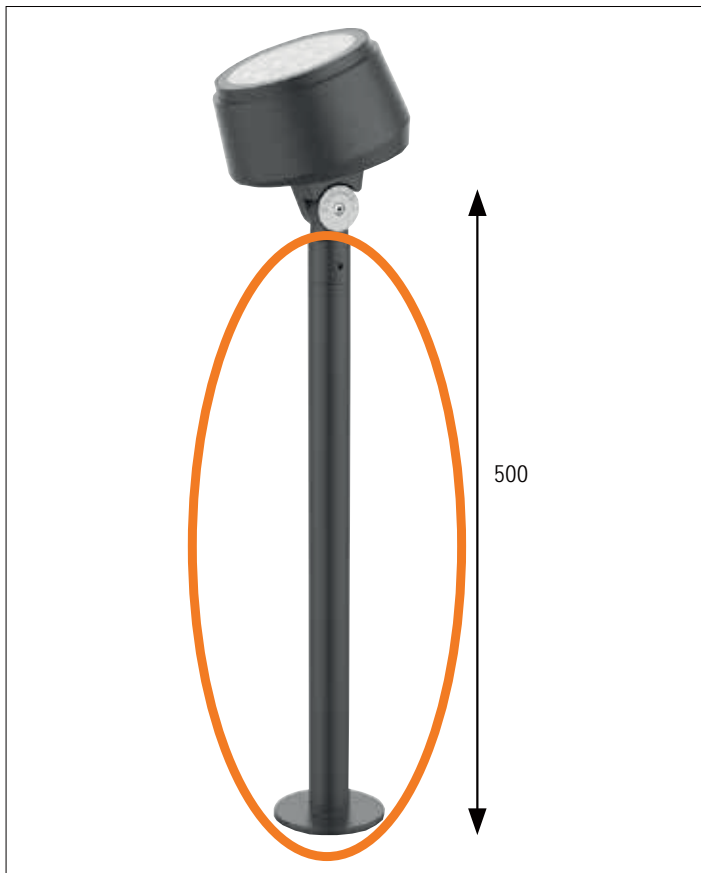

Cod. 215PA  
Palo per LED Ischia - *LED Ischia pole*



Cod. 24165  
Picchetto in alluminio - *Aluminium spike*

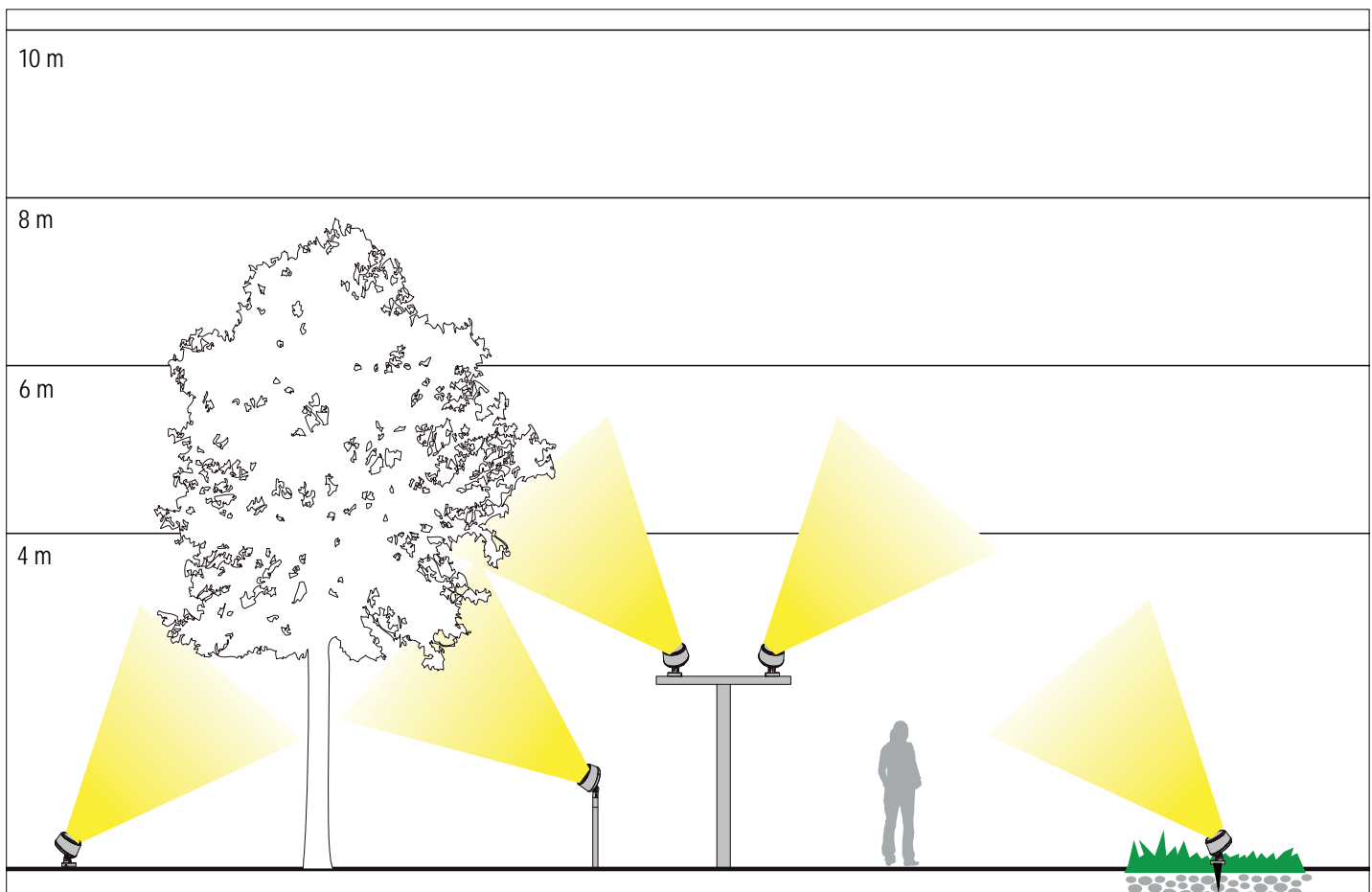



Outdoor

# LED Ovest

**3in1**



Paletto per l'illuminazione di giardini o parchi, con effetto di luce discreta.

**Installazione:** a terra

**Corpo:** in alluminio pressofuso UNI EN 1706, verniciato con polvere termoidurente poliesteri

**Verniciatura:** di tipo poliesteri eseguita a polvere, resistente agli agenti atmosferici e alla corrosione e garantita per 1.000 ore in nebbia salina. Colore Nero RAL 9005.

**Diffusore:** in policarbonato trasparente

**Driver:** incorporato

**Sorgente:** LED. Fattore di potenza  $\geq 0,92$ . Mantenimento del flusso luminoso al 80%. 50.000h (L80B20)

*Lighting bollard suitable for installation in gardens or parks, with soft effect.*

**Installation:** on ground

**Housing:** made by UNI EN 1706 die-cast aluminum, coated with polyester thermoset powder

**Coating:** coated with powdered polyester, resistant to atmospheric agents, corrosion and guaranteed for 1.000 hours in saline mist. Black RAL9005 color.

**Diffuser:** made by transparent polycarbonate

**Driver:** included

**Light source:** LED. Power factor  $\geq 0,92$ . maintenance of 80% minimum luminous flux: 50,000h (L80B20).

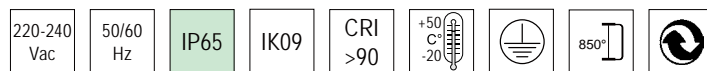

colour	H mm	W	Optic	K			lm	pcs	Kg	CELL
N	500	9,7	130°	4000			600	1	2,50	24198
N	500	9,7	130°	3000			600	1	2,50	24198/3K
N	800	9,7	130°	2700	3000	4000	600	1	5,00	241993CCT
N	800	25	130°	2700	3000	4000	2.250	1	5,00	24199PLUS3CCT

3CCT SWITCHABLE

3CCT SWITCHABLE

Outdoor

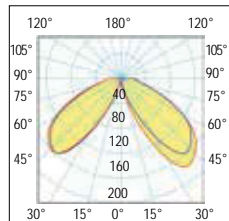

360°  
Diffondente - Wide

**Norme di riferimento**  
**Standard reference**  
EN60598-1  
EN60598-2-1  
EN62471  
EN62031  
EN60598-2-5  
EN61547

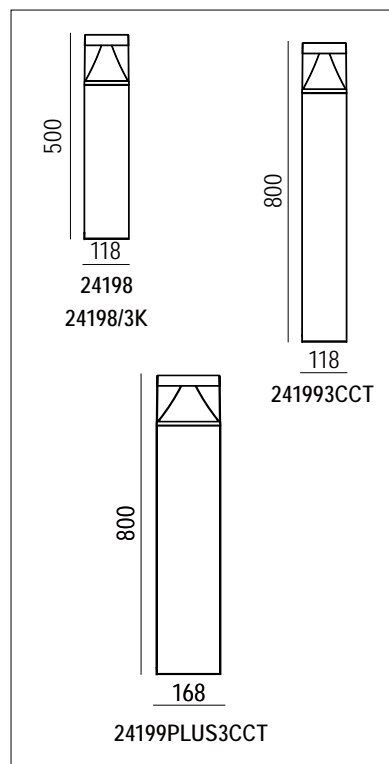

Funzione 3 CCT (2700K - 3000K - 4000K) modificabile con interruttore a cursore Slide switch 3 CCT (2700K - 3000K - 4000K) changeable function

A richiesta  
On demand

1-10Vdc

Pag. VI

DALI 2

Pag. VI

SENSOR

Pag. VI

# LED Cubo

**3 in 1**



Paletto per l'illuminazione di giardini o parchi, con effetto di luce discreta.

**Installazione:** a terra

**Corpo:** in alluminio pressofuso UNI EN 1706, verniciato con polvere termoindurente poliesteri

**Verniciatura:** di tipo poliesteri eseguita a polvere, resistente agli agenti atmosferici e alla corrosione e garantita per 1.000 ore in nebbia salina. Colore Nero RAL 9005.

**Diffusore:** in policarbonato trasparente (che previene efficacemente l'ingiallimento e l'invecchiamento)

**Driver:** incorporato.

**Sorgente:** LED. Fattore di potenza  $\geq 0,9$ . Mantenimento del flusso luminoso al 80%. 50.000h (L80B20)

*Bollard for lighting gardens or parks, with a discreet light effect.*

*Installation: on the ground*

*Body: in UNI EN 1706 die-cast aluminium, painted with polyester thermosetting powder*

*Painting: polyester type made with powder, resistant to atmospheric agents and corrosion and guaranteed for 1,000 hours in salt spray. Color Black RAL 9005.*

*Diffuser: in transparent polycarbonate (which effectively prevents yellowing and ageing)*

*Driver: built-in.*

*Source: LEDs. Power factor  $\geq 0.9$ . Lumen maintenance at 80%. 50.000h (L80B20)*

100-240 Vac	50/60 Hz	IP66	IK09	CRI >80	+50 C -20	850°	3 CCT
DRIVER INCLUDED		CE		3 CCT SWITCHABLE			

colour	H mm	W	Optic	K			lm	pcs	Kg	CELL
<b>N</b>	800	15	130°	3000			1125	1	2,80	24300
<b>N</b>	800	15	130°	2700	3000	4000	1125	1	2,80	24300-3CCT

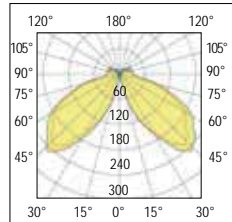

**360°**  
Diffondente - Wide

**Norme di riferimento**

*Standard reference*

- EN60598-1
- EN60598-2-1
- EN62471
- EN62031
- EN60598-2-5
- EN61547

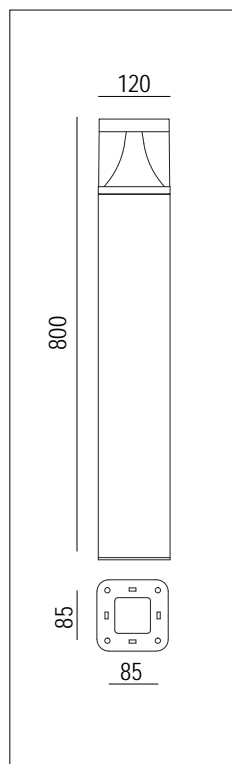

A richiesta  
*On demand*

**1-10Vdc**

Pag. VI

**DALI 2**

Pag. VI

**SENSOR**

Pag. VI



Outdoor

# LED Nord

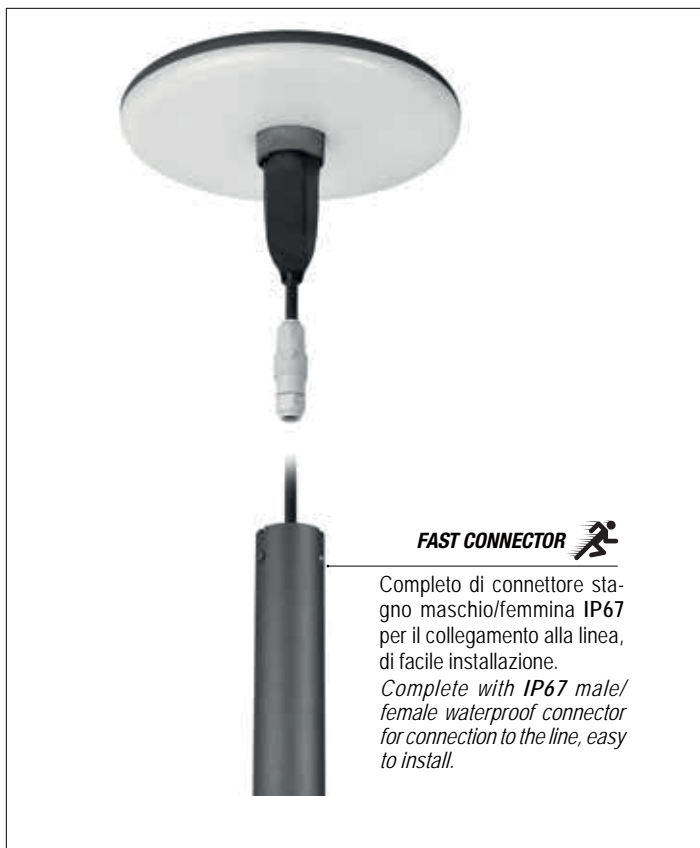

### FAST CONNECTOR

Completo di connettore stagno maschio/femmina IP67 per il collegamento alla linea, di facile installazione.  
 Complete with IP67 male/female waterproof connector for connection to the line, easy to install.

Paletto per l'illuminazione di giardini e parchi, con effetto di luce discreta. Illuminazione verso il basso a rispetto della normativa contro l'inquinamento luminoso.

Design pratico di facile installazione grazie al cavo presa e spina in dotazione il cablaggio è semplice e immediato, possibilità di scelta del palo in 3 diverse misure (da ordinare separatamente).

**Installazione:** a pavimento

**Corpo:** in alluminio pressofuso UNI EN 1706, verniciato con polvere termoindurente poliestere

**Verniciatura:** di tipo poliestere eseguita a polvere, resistente agli agenti atmosferici e alla corrosione e garantita per 1.000 ore in nebbia salina. Colore Antracite.

**Diffusore:** in policarbonato opalino infrangibile ed autoestinguente V2, stabilizzato ai raggi UV.

**Driver:** incorporato

**Sorgente:** LED **CREE**  Fattore di potenza  $\geq 0,90$ . Mantenimento del flusso luminoso al 80%. 50.000h (L80B20)

*Ballard for lighting private gardens or parks, with diffused, discreet and anti-light pollution effect, with a practical design and easy to install thanks to the socket and plug cable provided. The wiring is simple and immediate and the pole comes in 3 different sizes (to be ordered separately).*

**Installation:** floor

**Body:** in UNI EN 1706 die-cast aluminium, painted with thermohardening polyester powder

**Painting:** powder polyester coating, resistant to atmospheric agents and corrosion and guaranteed for 1,000 hours in salt spray. Colour: Anthracite.



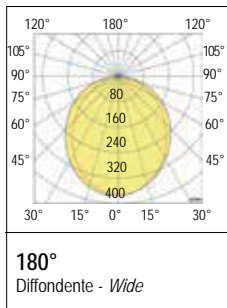
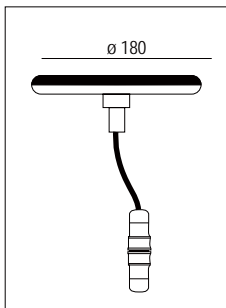

**Diffuser:** in V2 self-extinguishing and shatter-proof opal polycarbonate, UV stabilised.

**Driver:** built-in

**Source:** CREE LED. Power factor  $\geq 0,90$ . Maintenance of 80% luminous flux. 50.000h (L80B20).

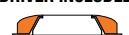

**Norme di riferimento**  
**Standard reference**  
 EN60598-1  
 EN60598-2-1  
 EN62471  
 EN62031  
 EN60598-2-5  
 EN61547

220-240 Vac	50/60 Hz	IP65	IK09	CRI >80	+40 C° -20		850° 		
<b>DRIVER INCLUDED</b> 		<b>CE</b> 							

colour	Ø mm	W	Optic	K	lm	pcs	Kg	CELL
<b>A</b>	180	10	120°	3000	720	1	0,8	25000



Accessori non inclusi - *Not included accessories*

colour	H mm	Description	CELL
A	380	Paolo Ø 40mm Pole Ø 40mm	25000/PAL38
A	750		25000/PAL75
A	1100		25000/PAL110

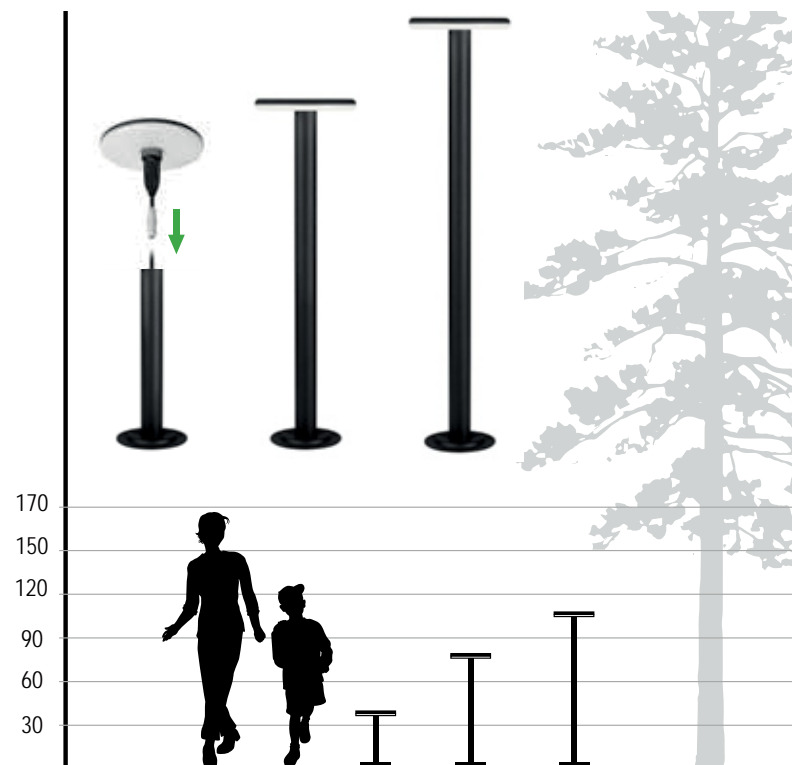
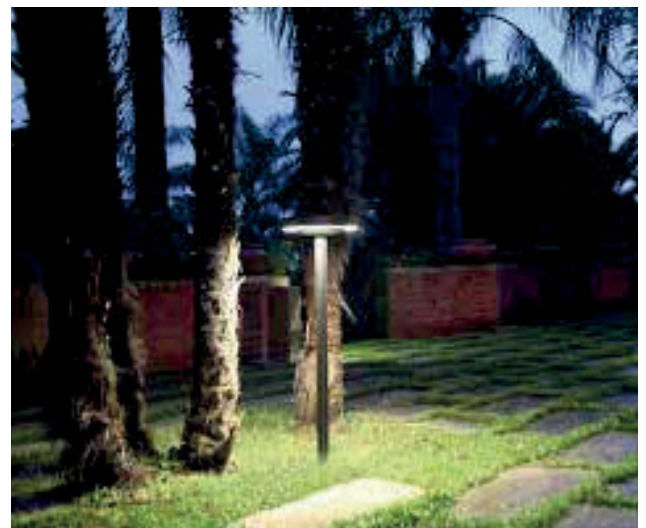
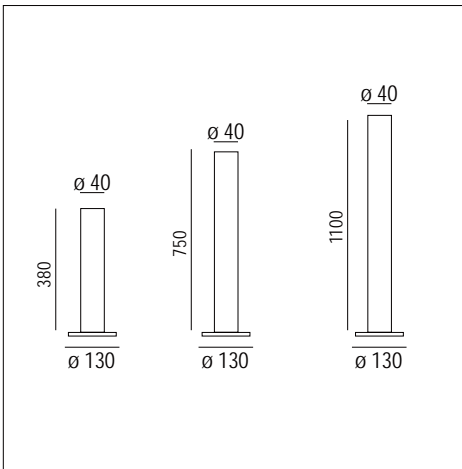

# LED Maga

**3in1**



Apparecchi di illuminazione a LED installazione fissa a parete o soffitto che trovano la propria corretta applicazione dove è richiesto un punto luce con emissione con angolo flood solo verso il basso oppure verso alto e basso. L'accurata scelta dei materiali ed i trattamenti superficiali contro la corrosione eseguiti su ogni componente rendono gli apparecchi adatti a qualsiasi condizione di utilizzo in ambienti esterni.

**Corpo:** in lega di alluminio pressofuso verniciato e altamente resistente alla corrosione.

**Verniciatura:** di tipo poliestere eseguita a polvere, resistente agli agenti atmosferici e alla corrosione e garantita per 1.000 ore in nebbia salina.

**Colore:** Nero RAL 9005 (LED Maga W e LED Maga C) - Bianco RAL 9003 (solo LED Maga C).

**Staffa a muro:** alluminio pressofuso EAN46100. Verniciatura di tipo poliestere, eseguita a polvere

**Schermo:** vetro borosilicato H.4mm. extra chiaro resistente agli shock termici e agli urti  
Driver: incorporato

**Sorgente:** LED **CREE**, mantenimento del flusso luminoso minimo al 80%: 50.000h (L80B10)

*Outdoor LED lighting fixtures for fixed installation on the wall or ceiling, suitable when a light source is needed with a flood angle emission only downwards or upwards and downwards. The careful choice of materials and surface treatments against corrosion performed on each component make the fixture suitable for any outdoor environment use.*

**Housing:** made by UNI 5076 die-cast aluminum, coated with polyester thermoset powder

**Coating:** coated with powdered polyester, resistant to atmospheric agents, corrosion and guaranteed for 1.000 hours in saline mist.

**Colour:** Black RAL 9005 color (LED Maga W and LED Maga C) - White RAL 9003 color (only LED Maga C).

**Wall bracket:** EAN46100 die-cast aluminium. Painting: powder polyester coating.

**Screen:** extra-light borosilicate glass resistant to thermal shocks and impacts (satin-finish upon request)

**Driver:** included

**Source:** LED **CREE**, maintenance of 80% minimum luminous flux: 50,000h (L80B10)

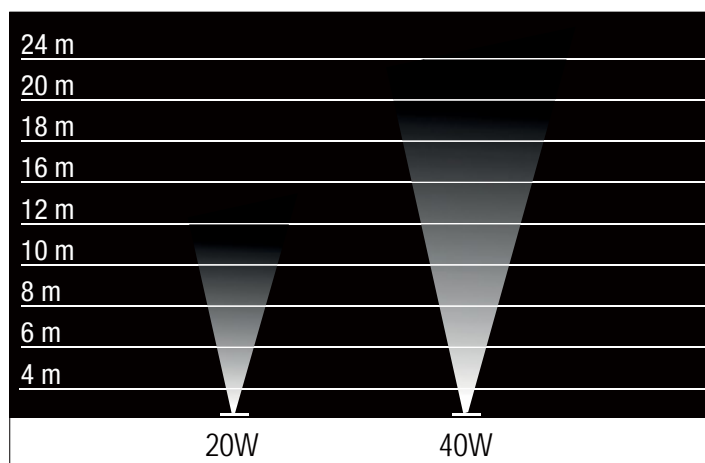
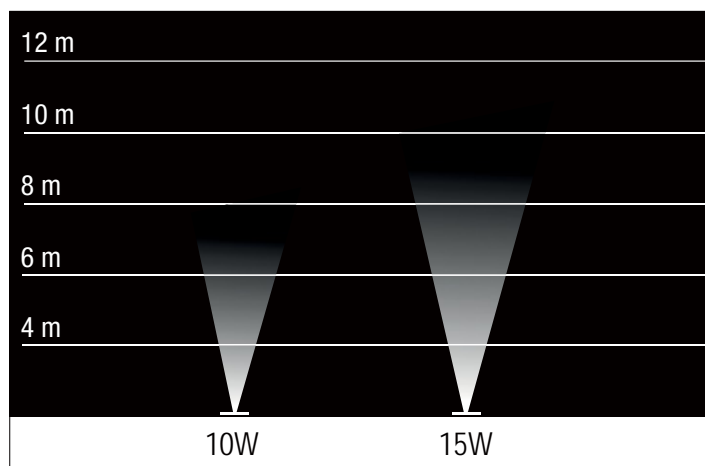

# LED Maga W UP & DOWN - Ø 110mm - Ø 144mm



220-240  
Vac

50/60  
Hz

IP66

IK08

CRI  
>80

+40  
C°  
-20



850°



DRIVER INCLUDED

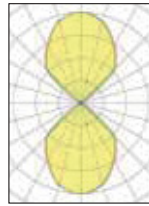

colour	W	Optic	K			lm	pcs	Kg	CELL
<b>N</b>	2x10	80°	3000			2x850	1	1,20	32323-3K
<b>N</b>	2x20	80°	4000			2x1900	1	1,40	32323
<b>N</b>	2x20	80°	3000			2x1900	1	1,40	32323-10
<b>N</b>	2x20	80°	3000	4000	5000	2x1900	1	1,40	32323-3CCT

3CCT  
SWITCHABLE

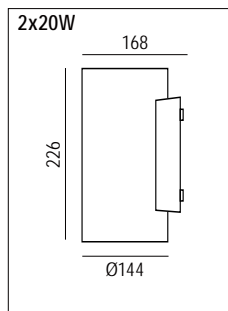
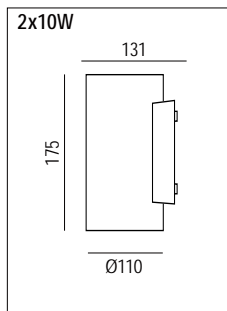

Outdoor

# LED Maga W - Ø 110mm - Ø 144mm



220-240 Vac
50/60 Hz
IP66
IK08
CRI >80
+40°C / -20°C
850°
850°
DRIVER INCLUDED

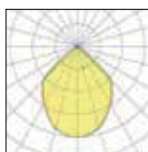

colour	W	Optic	K			lm	pcs	Kg	CELL
<b>N</b>	20	80°	4000			1900	1	1,40	32313
<b>N</b>	20	80°	3000			1900	1	1,40	32313-10
<b>N</b>	10	80°	3000	4000	5000	950	1	1,20	32313-103CCT

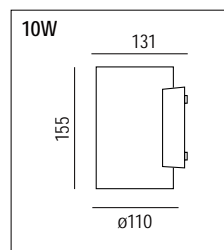
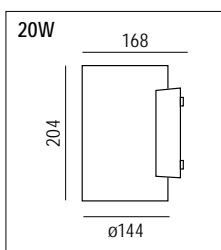

Outdoor



# LED Maga C (Ø 126mm / Ø 168mm)



220-240  
Vac

50/60  
Hz

IP66

IK08

CRI  
>80

+40  
C  
-20



850°



DRIVER INCLUDED

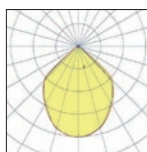

colour	W	Optic	K			lm	pcs	Kg	CELL
N	15	100°	3000	4000	5000	1000	1	1,10	32299-3CCT
B	15	100°	3000	4000	5000	1000	1	1,10	32299/WH/3CCT
B	15	100°	3000			1000	1	1,10	32299/3K/WH
N	40	100°	3000	4000	5000	2600	1	2,20	32322-3CCT

3CCT  
SWITCHABLE

3CCT  
SWITCHABLE

3CCT  
SWITCHABLE

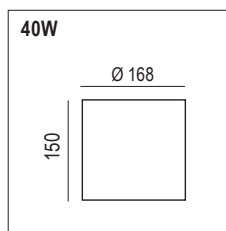
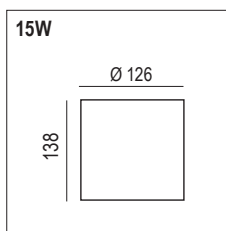

Funzione 3 CCT (3000K - 4000K - 5000K) modificabile con interruttore a cursore

Slide switch 3 CCT (3000K - 4000K - 5000K) changeable function

**A RICHIESTA - ON REQUEST**  
LED Maga C Emer 3h.



Outdoor

**3in1**



# LED Asso Round

LED Asso Round è un'applicazione a LED dal design cilindrico.

**Corpo:** il corpo è in alluminio e impermeabile

**Diffusore:** policarbonato satinato con rivestimento UV, resistente ai raggi UV.

**Verniciatura:** di tipo poliestere eseguita a polvere, resistente agli agenti atmosferici e alla corrosione e garantita per 1.000 ore in nebbia salina.

Colore Nero RAL 9005 o bianco RAL9016

L'angolo del fascio di 360 gradi può fornire prestazioni di illuminazione brillanti.

Solo la direzione della luce verso l'alto e la direzione della luce verso l'alto e verso il basso per l'opzione. È materiale

Dimmerabile con dimmer TRIAC.

**Norme di riferimento:** EN60598-1; EN60598-2-1; EN62471; EN62031; EN60598-2-5; EN61547

LED Asso Round is a cylindrical design LED wall light.

**Body:** The body is made of aluminum and waterproof

**Diffuser:** UV coated satin polycarbonate, UV resistant.

**Painting:** polyester powder type, resistant to atmospheric agents and corrosion and guaranteed for 1,000 hours in saline mist.

Color Black RAL 9005 or white RAL9016

The 360 degree beam angle can provide brilliant lighting performance.

Only the direction of the light upwards and the direction of the light upwards and downwards for the option. It is material

Dimmable with TRIAC dimmer.

**Reference number:** EN60598-1; EN60598-2-1; EN62471; EN62031; EN60598-2-5; EN61547

# LED Asso Round



220-240 Vac	50/60 Hz	IP65	IK08	CRI >80	+40°C -20°C	750°	DRIVER INCLUDED
-------------	----------	------	------	---------	----------------	------	-----------------



colour	W	Optic	K			lm	pcs	Kg	CELL
<b>N</b>	8	170°	3000	4000	5700	670	1	0,90	RL28C76BL8WP3
<b>B</b>	8	170°	3000	4000	5700	670	1	0,90	RL28C76WH8WP3

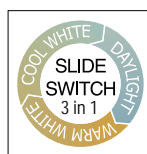
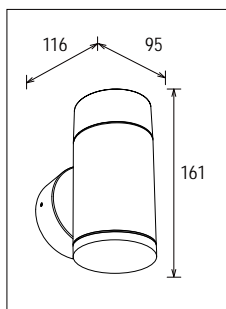

Funzione 3 CCT (3000K - 4000K - 5700K) modificabile con interruttore a cursore

Slide switch 3 CCT (3000K - 4000K - 5700K) changeable function

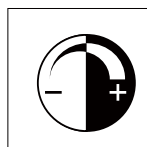

Regolabile con dimmer a TRIAC  
Dimmable with TRIAC dimmer

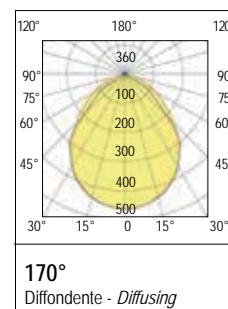

# LED Asso Round Up & Down



220-240 Vac	50/60 Hz	IP65	IK08	CRI >80	+40°C -20°C	750°	DRIVER INCLUDED
-------------	----------	------	------	---------	----------------	------	-----------------



colour	W	Optic	K			lm	pcs	Kg	CELL
<b>N</b>	2x4	170°	3000	4000	5700	670	1	0,90	RL28B76BL8WP3
<b>B</b>	2x4	170°	3000	4000	5700	670	1	0,90	RL28B76WH8WP3

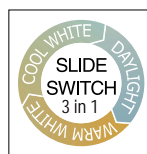
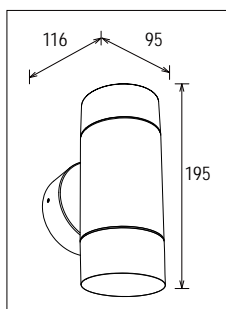

Funzione 3 CCT (3000K - 4000K - 5700K) modificabile con interruttore a cursore

Slide switch 3 CCT (3000K - 4000K - 5700K) changeable function

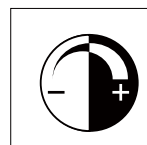

Regolabile con dimmer a TRIAC  
Dimmable with TRIAC dimmer

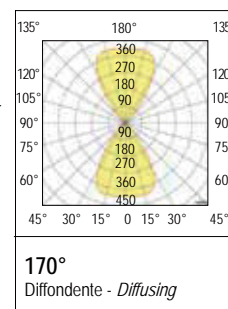

Outdoor

**3in1**



# LED Asso Square Down - LED Asso Square Up & Down

Appliche ideale per illuminare ingressi o facciate e elementi architettonici.

**Installazione:** soffitto o parete

**Corpo e telaio:** in alluminio pressofuso UNI EN 1706 verniciato con polvere termoisolante poliester

**Diffusore:** policarbonato satinato con rivestimento UV, resistente ai raggi UV.

**Verniciatura:** di tipo poliester eseguita a polvere, resistente agli agenti atmosferici e alla corrosione e garantita per 1.000 ore in nebbia salina.

Colore Nero RAL 9005 o bianco RAL9016

**Driver:** incorporato

**Sorgente:** LED SMD

Doppio ingresso Loop In/Out e terminale rapido per una rapida installazione

CCT intercambiabile (3000K + 4000K + 5700K) con interruttore a scorrimento

Ideal wall lamp to illuminate entrances or facades and architectural elements.

**Installation:** ceiling or wall

**Body and frame:** die-cast aluminum UNI EN 1706 painted with polyester thermosetting powder

**Diffuser:** UV coated satin polycarbonate, UV resistant.

**Painting:** polyester powder type, resistant to atmospheric agents and corrosion and guaranteed for 1,000 hours in saline mist.

Color Black RAL 9005 or white RAL9016

**Driver:** built-in

**Source:** LED SMD

Double Loop In / Out input and quick terminal for quick installation

Interchangeable CCT (3000K + 4000K + 5700K) with slide switch

## LED Asso square



220-240 Vac	50/60 Hz	IP65	IK08	CRI >80	+45 C -20	750°	DRIVER INCLUDED	CE
-------------	----------	------	------	---------	--------------	------	-----------------	----

colour	W	Optic	Lm	K			pcs	Kg	CELL
<b>N</b>	4	120°	450	3000	4000	5700	1	0,64	RL113BL4WP3
<b>B</b>	4	120°	450	3000	4000	5700	1	0,64	RL113WH4WP3

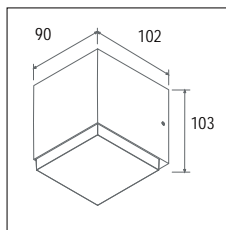

Funzione 3 CCT (3000K - 4000K - 5700K) modificabile con interruttore a cursore

Slide switch 3 CCT (3000K - 4000K - 5700K) changeable function

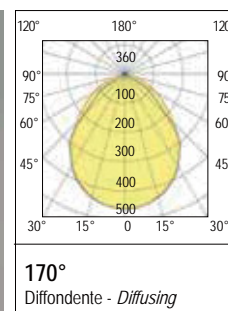

## LED Asso square Up & Down

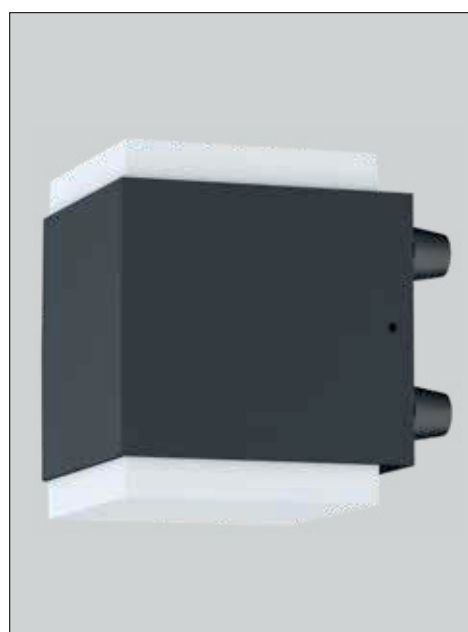

220-240 Vac	50/60 Hz	IP65	IK08	CRI >80	+45 C -20	750°	DRIVER INCLUDED	CE
-------------	----------	------	------	---------	--------------	------	-----------------	----

colour	W	Optic	Lm	K			pcs	Kg	CELL
<b>N</b>	2x4	120°	900	3000	4000	5700	1	0,56	RL113CBL4WP3
<b>B</b>	2x4	120°	900	3000	4000	5700	1	0,56	RL113CWH4WP3

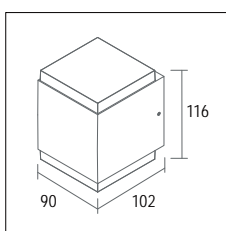

Funzione 3 CCT (3000K - 4000K - 5700K) modificabile con interruttore a cursore

Slide switch 3 CCT (3000K - 4000K - 5700K) changeable function

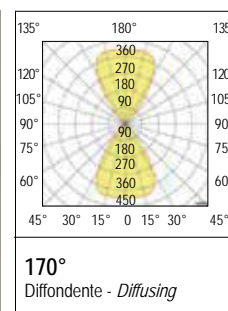

Outdoor

## LED Su & Giù



Appliche ideate per illuminare ingressi o facciate e elementi architettonici.

**Installazione:** a parete

**Corpo e telaio:** in alluminio pressofuso UNI EN 1706 verniciato con polvere termoisolante poliestere

**Verniciatura:** di tipo poliestere eseguita a polvere, resistente agli agenti atmosferici e alla corrosione e garantita per 1.000 ore in nebbia salina. Colore Nero RAL 9005 o Bianco RAL 9003

**Ottica:** regolabile solo per il modello Su & Giù. Per il modello Doppio Su & Giù l'ottica non è regolabile

**Driver:** incorporato

**Sorgente:** LED **CREE** manutenzione del flusso luminoso minimo al 80%: 50.000h (L80B10).

*Wall luminaire made by die-cast aluminum perfect to light up facades and architectural elements.*

**Installation:** wall use

**Housing and frame:** made by UNI EN 1706 die-cast aluminum, coated with polyester thermoset powder

**Coating:** coated with powdered polyester, resistant to atmospheric agents, corrosion and guaranteed for 1.000 hours in saline mist. Black RAL9005 or White RAL 9003

**Optic:** adjustable only for the Up & Down model. For the Double Up & Down model, the optics are not adjustable

**Driver:** included

**Light source:** LED **CREE** maintenance of 80% minimum luminous flux: 50,000h (L80B10).

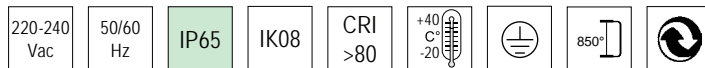

colour	W	K			lm	pcs	Kg	CELL
<b>N</b>	2x4,5W	2700	3000	4000	2x375	1	1,50	32292-3CCT
<b>B</b>	2x4,5W	2700	3000	4000	2x375	1	1,50	32291-3CCT

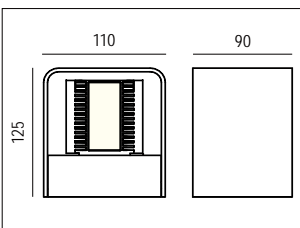

**Norme di riferimento**  
**Standard reference**  
EN60598-1  
EN60598-2-1  
EN62471  
EN62031  
EN60598-2-5  
EN61547

Outdoor

**Alette orientabili per l'emissione della luce con diverse inclinazioni - Adjustable fins to allow the emission of light with different inclinations**



## LED Doppio Su & Giù

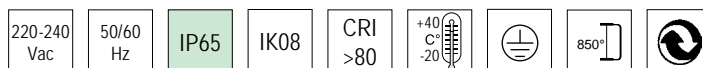
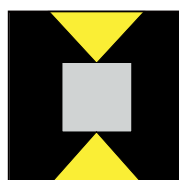

colour	W	K			lm	pcs	Kg	CELL
<b>N</b>	2x9	2700	3000	4000	2x700	1	1,50	32292-23CCT

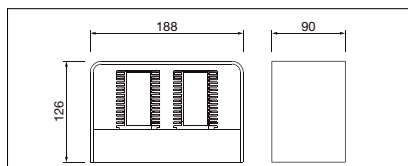





# LED Micro Solo Giù Round - LED Medio Solo Giù Square

Plafoniera a LED idonea per applicazioni civili per l'illuminazione di camminamenti residenziali, spazi commerciali o alberghieri.

Le linee quadrate e circolari semplici combinate con la sorgente di luce a LED indiretta possono creare un ambiente di illuminazione bello e morbido.

L'applicazione può essere utilizzata sia in ambienti interni che esterni.

**Corpo:** realizzato in lega di alluminio ad alta resistenza e resistente ai raggi UV.

**Diffusore:** in vetro temprato 4mm

**Colore:** Nero RAL9005 o Bianco RAL9016

**Installazione:** a parete

**Verniciatura:** di tipo poliestere eseguita a polvere, resistente agli agenti atmosferici e alla corrosione

**Norme di riferimento:** EN60598-1; EN60598-2-1; EN62471; EN62031; EN60598-2-5; EN61547

*LED ceiling light suitable for civil applications for the lighting of residential walkways, commercial or hotel spaces.*

*Simple square and circular lines combined with indirect LED light source can create a beautiful and soft lighting environment.*

*The wall lamp can be used both indoors and outdoors.*

**Body:** made of high strength and UV resistant aluminum alloy.

**Diffuser:** in 4mm tempered glass

**Color:** Black RAL9005 or White RAL9016

**Installation:** on the wall

**Painting:** polyester powder type, resistant to atmospheric agents and corrosion

**Reference number:** EN60598-1; EN60598-2-1; EN62471; EN62031; EN60598-2-5; EN61547

## LED Micro Solo Giù Round



200-240 Vac	50/60 Hz	IP65	IK08	CRI >80	+45°C -20°C	750°	DRIVER INCLUDED	CE	
colour	W	Optic	K	lm	pcs	Kg	CELL		
<b>N</b>	5	ASY	3000	170	1	0,33	RLRO59A5W3KBL		
<b>B</b>	5	ASY	3000	170	1	0,33	RLRO59A5W3KWH		

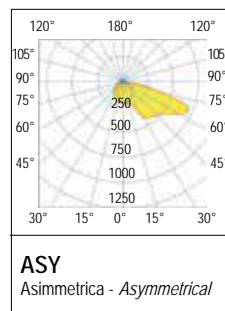
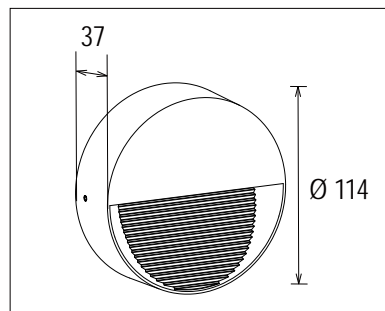

Outdoor

## LED Medio Solo Giù Square



200-240 Vac	50/60 Hz	IP65	IK08	CRI >80	+45°C -20°C	750°	DRIVER INCLUDED	CE	
colour	W	Optic	K	lm	pcs	Kg	CELL		
<b>N</b>	5	ASY	3000	170	1	0,39	RLSQ59A5W3KBL		
<b>B</b>	5	ASY	3000	170	1	0,39	RLSQ59A5W3KWH		

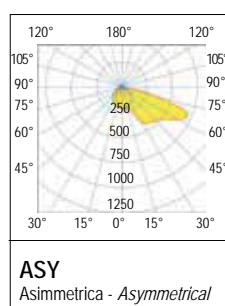
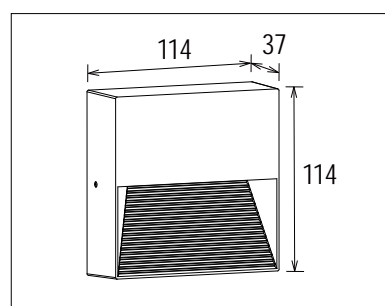

# LED Sologìù R - LED Sologìù S

Plafoniera a LED idonea per applicazioni civili per l'illuminazione di camminamenti residenziali, spazi commerciali o alberghieri.

**Installazione:** a parete

**Corpo:** in alluminio pressofuso UNI EN 1706, verniciato con polvere termoindurente poliestere

**Verniciatura:** di tipo poliestere eseguita a polvere, resistente agli agenti atmosferici e alla corrosione e garantita per 1.000 ore in nebbia salina. Colore Antracite RAL7024.

**Diffusore:** in vetro temperato piano extrachiaro.

**Cablaggio:** con doppio ingresso cavi.

**Sorgente:** LED **SAMSUNG** mantenimento del flusso luminoso minimo al 80%: 50.000h (L80B10).

*LED ceiling light suitable for civil applications for the lighting of residential walkways, commercial or hotel spaces.*

**Installation:** wall mounting

**Housing:** made by UNI EN 1706 die-cast aluminum, coated with polyester thermoset powder

**Coating:** coated with powdered polyester, resistant to atmospheric agents, corrosion and guaranteed for 1.000 hours in saline mist. Anthracite color RAL7024.

**Diffuser:** in extra-clear flat tempered glass.

**Wiring:** with double cable entry.

**Light source:** LED **SAMSUNG** maintenance of 80% minimum luminous flux: 50,000h (L80B10).

220-240 Vac	50/60 Hz	IP65	IK06	+40 C° -20		850°		CE	DRIVER INCLUDED 	
----------------	-------------	------	------	------------------	--	------	--	----	---------------------	--

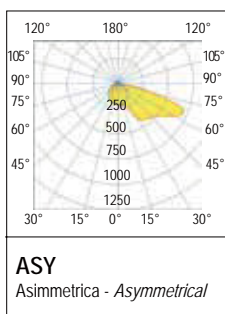
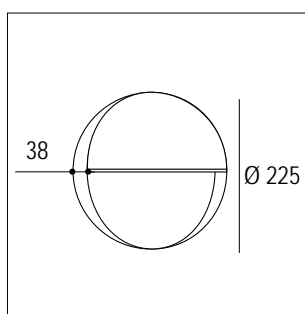

LED Sologìù R							
colour	W	Optic	K	lm	pcs	Kg	CELL
A	8,5	ASY	3000	300	1	0,8	SOLOGIUR

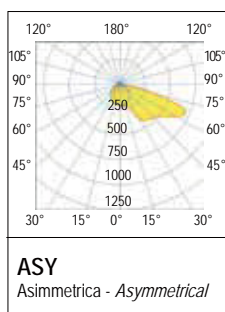
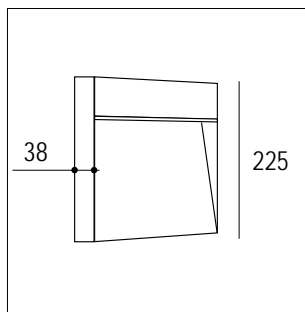

LED Sologìù S							
colour	W	Optic	K	lm	pcs	Kg	CELL
A	8,5	ASY	3000	300	1	0,8	SOLOGIUS

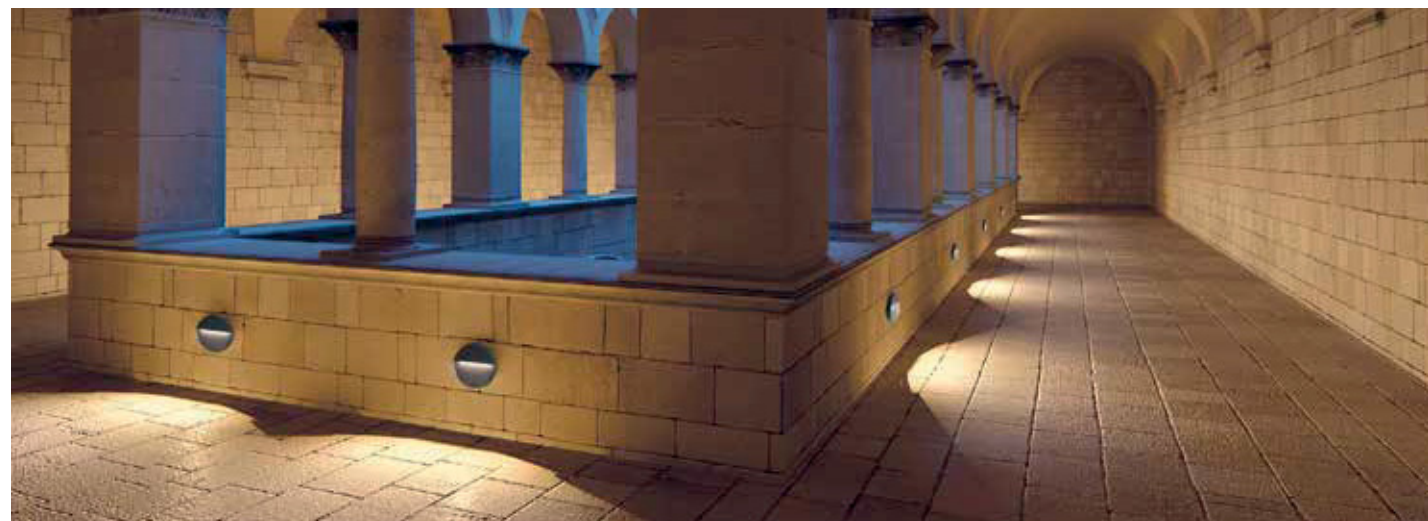

Outdoor

# LED Mole

La lampada da parete LED Mole è un design di illuminazione up & down

**Corpo:** in alluminio pressofuso per un'eccellente dissipazione termica. la superficie della lampada è spruzzata con polvere di granelli di sabbia per esterni, resistente alla corrosione

**Diffusore:** in vetro temprato 4mm

**Verniciatura:** Nero RAL 9005 o Bianco RAL 9016 (anti corrosione e resistente agli agenti atmosferici)

**Sorgente:** LED SMD

**Installazione:** a parete sia per interno che per esterno

**Alimentazione:** inclusa

Il design della struttura robusta, l'impermeabilità IP65 si adatta a un'area di applicazione più ampia.

The Mole LED wall lamp is an up & down lighting design

**Body:** in die-cast aluminum for excellent heat dissipation. The surface of the lamp is sprayed with outdoor sand grain powder, corrosion resistant

**Source:** SMD LED

**Diffuser:** in 4mm tempered glass

**Paint:** Black RAL 9005 or White RAL 9016 (corrosion and weather resistant)

**Installation:** one wall for both indoor and outdoor

**Power supply:** included

Rugged structure design, IP65 waterproofing suits larger application area.



220-240 Vac	50/60 Hz	IP65	IK03	+45 C° -20		750°	
----------------	-------------	------	------	------------------	--	------	--

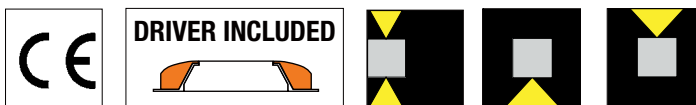

colour	W	Optic	Lm	K			pcs	Kg	CELL
<b>N</b>	10	180°	700	3000	4000	5700	1	0,71	RL88-10W-BL3P
<b>B</b>	10	180°	700	3000	4000	5700	1	0,71	RL88-10W-WH3P

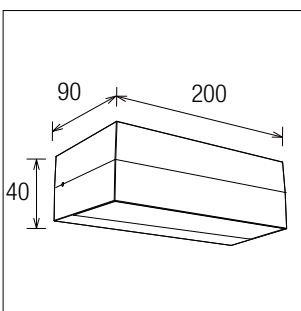

Funzione 3 CCT (3000K - 4000K - 5700K) modificabile con interruttore a cursore  
Slide switch 3 CCT (3000K - 4000K - 5700K) changeable function

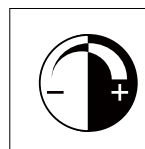

Regolabile con dimmer a TRIAC o IGBT  
Dimmable with TRIAC or IGBT dimmer

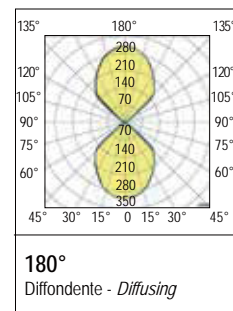

Interruttore a cursore a 3 posizioni per selezionare la direzione luminosa  
3-position slider switch to select the light direction



Outdoor





## LED Fiamma nera

LED Fiamma nera, applique a LED di colore nero dal design minimal, realizzata con metallo pressofuso; emette una luce soffusa diretta o indiretta che viene riflessa sulla parete creando un'atmosfera intima e priva di abbagliamenti. La temperatura massima superficiale di tutte le parti accessibili sotto i 50 gradi per garantire sicurezza e affidabilità

**Corpo:** il corpo è in alluminio e impermeabile

**Diffusore:** vetro temperato bianco, con alto comfort visivo e una distribuzione uniforme dell'illuminazione.

**Verniciatura:** di tipo poliestere eseguita a polvere, resistente agli agenti atmosferici e alla corrosione e garantita per 1.000 ore in nebbia salina.

**Colore:** Nero RAL 9005.

Dimmerabile con dimmer TRIAC.

**Nome di riferimento:** EN60598-1; EN60598-2-1; EN62471; EN62031; EN60598-2-5; EN61547

*LED Fiamma nera, wall light, a black LED wall light with a minimalist design, made of die-cast metal; it emits a soft, direct or indirect light that reflects onto the wall, creating an intimate, glare-free atmosphere.*

*The maximum surface temperature of all accessible parts is below 50 degrees Celsius to ensure safety and reliability.*

**Body:** The body is made of aluminum and waterproof

**Diffuser:** White tempered glass, ensuring high visual comfort and uniform light distribution.

**Painting:** Polyester powder coating, resistant to weather and corrosion, and guaranteed for 1,000 hours in saline mist.

**Color:** Black RAL 9005.

Dimmable with TRIAC dimmer.

**Reference number:** EN60598-1; EN60598-2-1; EN62471; EN62031; EN60598-2-5; EN61547

## LED Fiamma nera Up



220-240 Vac	50/60 Hz	IP65	IK08	CRI >80	+40 C° -20	750°	750°	DRIVER INCLUDED
-------------	----------	------	------	---------	---------------	------	------	-----------------

**CE** Nessun rischio foto-biologico, in conformità con la EN 62471:2008.  
No photobiological risk, in compliance with EN 62471:2008.

colour	W	Optic	K	lm	pcs	Kg	CELL
<b>N</b>	9	100°	3000	750	1	0,90	RL14LED9-3K
<b>N</b>	9	100°	4000	750	1	0,90	RL14LED9-4K

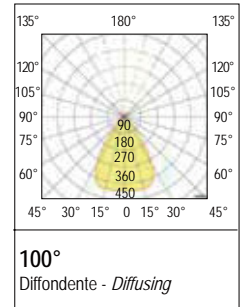
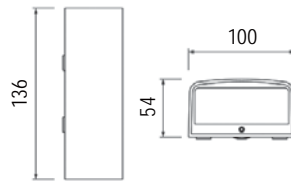

Outdoor

## LED Fiamma nera Up e Down

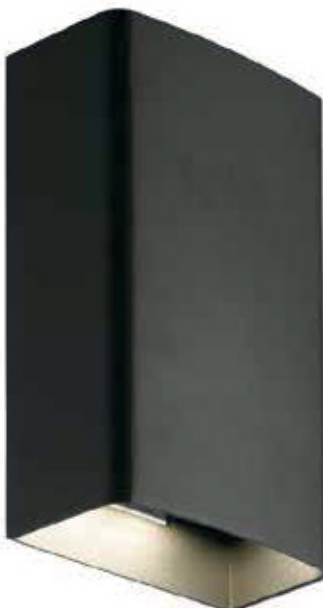

220-240 Vac	50/60 Hz	IP65	IK08	CRI >80	+40 C° -20	750°	750°	DRIVER INCLUDED
-------------	----------	------	------	---------	---------------	------	------	-----------------

**CE**

colour	W	Optic	K	lm	pcs	Kg	CELL
<b>N</b>	2x6	100°	3000	1080	1	0,90	RL14LED12-3K
<b>N</b>	2x6	100°	4000	1080	1	0,90	RL14LED12-4K

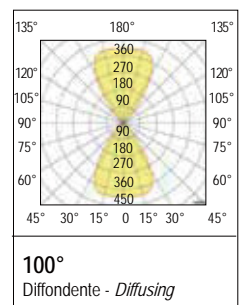
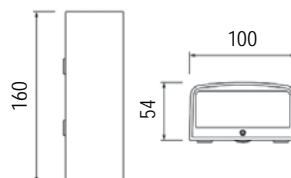

**2in1**





## LED Memme

LED Memme, applique a LED di colore nero dal design minimal, emette una luce soffusa indiretta che viene riflessa sulla parete creando un'atmosfera intima e priva di abbagliamenti.

**Corpo:** il corpo è in alluminio e impermeabile

**Diffusore:** policarbonato satinato con rivestimento UV, resistente ai raggi UV.

**Verniciatura:** di tipo poliestere eseguita a polvere, resistente agli agenti atmosferici e alla corrosione e garantita per 1.000 ore in nebbia salina.

Colore Nero RAL 9005.

**Nrome di riferimento:** EN60598-1; EN60598-2-1; EN62471; EN62031; EN60598-2-5; EN61547

*LED Memme, a black LED wall light with a minimal design, emits a soft indirect light that is reflected on the wall, creating an intimate, glare-free atmosphere.*

**Body:** The body is made of aluminum and waterproof

**Diffuser:** UV coated satin polycarbonate, UV resistant.

**Painting:** polyester powder type, resistant to atmospheric agents and corrosion and guaranteed for 1,000 hours in saline mist.

Color Black RAL 9005.

**Reference number:** EN60598-1; EN60598-2-1; EN62471; EN62031; EN60598-2-5; EN61547

## LED Memme 12



220-240 Vac	50/60 Hz	IP65	IK03	CRI >80	+45 C° -20	750°	750°	DRIVER INCLUDED
----------------	-------------	------	------	------------	------------------	------	------	-----------------



colour	W	Optic	K		lm	pcs	Kg	CELL
N	12	100°	3000	4000	950	1	0,90	RL182300-12W

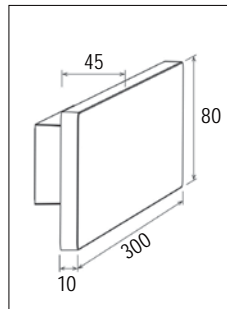

Funzione 2 CCT (3000K - 4000K) modificabile con interruttore a cursore.  
Slide switch 2 CCT (3000K - 4000K) changeable function.

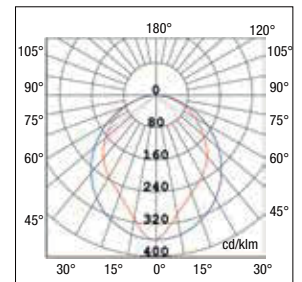

Outdoor

## LED Memme 18



220-240 Vac	50/60 Hz	IP65	IK03	CRI >80	+45 C° -20	750°	750°	DRIVER INCLUDED
----------------	-------------	------	------	------------	------------------	------	------	-----------------



colour	W	Optic	K		lm	pcs	Kg	CELL
N	18	100°	3000	4000	950	1	0,90	RL182300-18W

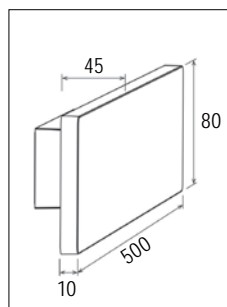

Funzione 2 CCT (3000K - 4000K) modificabile con interruttore a cursore.  
Slide switch 2 CCT (3000K - 4000K) changeable function.

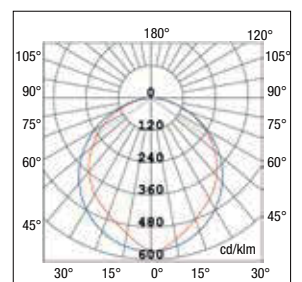

## LED Roma



Outdoor

### LED Roma

Plafoniera a LED stagna, idonea per applicazioni civili, commerciali, alberghiere.

**Corpo e cornice:** alluminio pressofuso laccato bianco, grigio e nero di serie, a richiesta versione oro, guarnizione in silicone, viti Torx anti-vandalo imperdibili.

**Verniciatura:** di tipo poliestere eseguita a polvere, resistente agli agenti atmosferici e alla corrosione e garantita per 1.000 ore in nebbia salina. Colore Nero RAL 9005.

**Diffusore:** in policarbonato opale, antiurto ed autoestinguente resistente agli UV.

**Cablaggio:** composto da alimentazione 220-240V 50Hz, cavi in PVC HT 105° non propagante la fiamma, doppio isolamento. LED Roma è installabile sia per impianto sotto parete che esterno.

**Conforme alla norma:** EN60598-1, RG0 nessun rischio fotobiologico ai fini della norma EN62471.

**Sorgente:** LED SMD2835

**Led:** mantenimento del flusso luminoso minimo al 80%: 50.000h (L80B10).

**Driver multipotenza** : incluso.

**Grado IP:** IP65 certificato da laboratorio accreditato

### LED Roma

Compact waterproof LED fitting suitable for civil, commercial, hotel applications, etc.

**Body and frame:** white, gray and black lacquered die-cast aluminum as standard, on request gold, silicone gasket, non-loosening Torx screws.

**Painting:** polyester powder type, resistant to atmospheric agents and corrosion and guaranteed for 1,000 hours in saline mist. Color Black RAL 9005.

**Diffuser:** made by shockproof and self-extinguishing opal polycarbonate, UV resistant.

**Wiring:** includes 220-240V 50Hz control gear, non-flame propagating PVC HT 105° cables, double insulated. LED Roma can be installed in both concealed and outdoor circuits.

**According to standard:** EN60598-1, RG0 exempt from photo-biological risks in compliance with standard EN62471.

**Source:** LED SMD2835

**Led:** maintenance of minimum luminous flux to 80%: 50.000h (L80B10).

**Driver multipower** : included.

**IP degree:** IP65 certified by an external laboratory

# LED Roma

220-240V 50/60Hz   75°  **IK08** **IP65**

## LED Roma

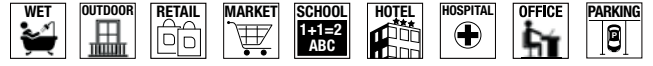

**CRI 80**



**DRIVER INCLUDED**  
MULTIPOWER

+45  
C°  
-20

**FLICKER FREE**

**RG0**



	colour	W	Lm output	Optic	K	pcs	Kg	CELL		
	<b>N</b>	8-12-15	995-1610-2055	130°	3000	4000	001	1,350	ROMA2CCT15BL	
	<b>N</b>	8-12-15	1060-1580-2070	130°	3000	4000	001	1,350	ROMA2CCT15BLD	



Funzione 2 CCT (3000K - 4000K) modificabile con interruttore a cursore.  
*Slide switch 2 CCT (3000K - 4000K) changeable function.*

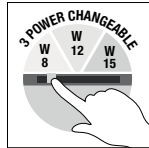

Funzione 3 POTENZE (8W - 12W-15W) modificabile con interruttore a cursore.  
*Slide switch 3 POWER (8W - 12W-15W) changeable function.*

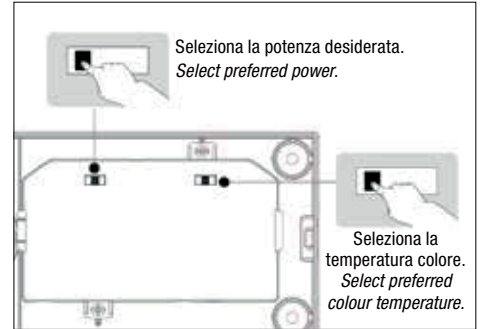

## Dati fotometrici - Photometric data

**8W**

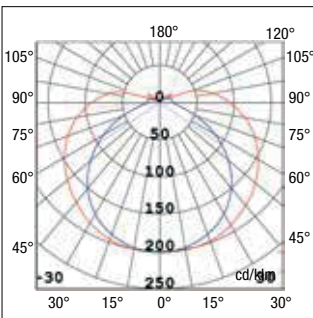

**12W**

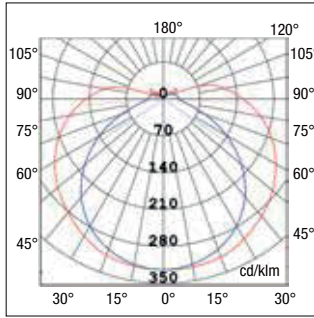

**15W**

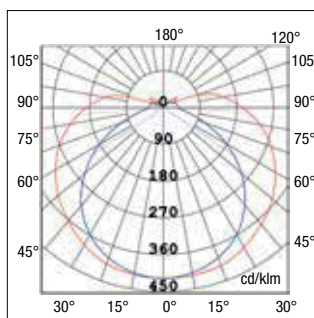

Outdoor

## LED Salò

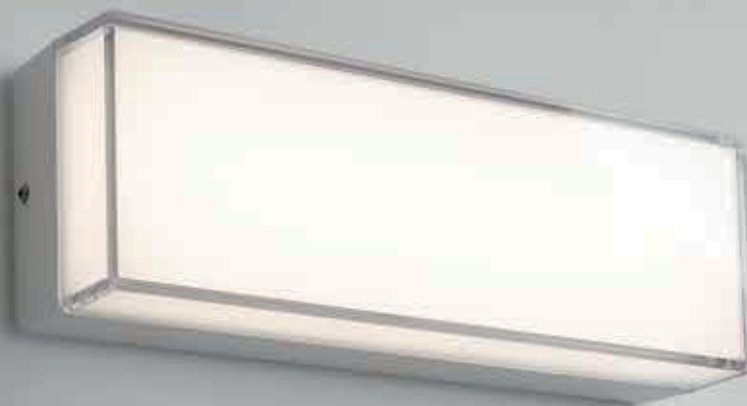

Outdoor

### LED Salò

Plafoniera a LED stagna, idonea per applicazioni civili, commerciali, alberghiere.

**Corpo e cornice:** alluminio pressofuso laccato bianco, grigio e nero di serie, a richiesta versione oro, guarnizione in silicone, viti Torx anti-vandalo imperdibili.

**Verniciatura:** di tipo poliestere eseguita a polvere, resistente agli agenti atmosferici e alla corrosione e garantita per 1.000 ore in nebbia salina. Colore Bianco RAL 9016.

**Diffusore:** in policarbonato opale, antiurto ed autoestinguente resistente agli UV.

**Cablaggio:** composto da alimentazione 220-240V 50Hz, cavi in PVC HT 105° non propagante la fiamma, doppio isolamento. LED Salò è installabile sia per impianto sotto parete che esterno.

**Conforme alla norma:** EN60598-1, RG0 nessun rischio fotobiologico ai fini della norma EN62471.

**Sorgente:** LED SMD2835

**Led:** mantenimento del flusso luminoso minimo al 80%: 50.000h (L80B10).

**Driver multipotenza** : incluso.

**Grado IP:** IP65 certificato da laboratorio accreditato

### LED Salò

Compact waterproof LED fitting suitable for civil, commercial, hotel applications, etc.

**Body and frame:** white, gray and black lacquered die-cast aluminum as standard, on request gold, silicone gasket, non-loosening Torx screws.

**Painting:** polyester powder type, resistant to atmospheric agents and corrosion and guaranteed for 1,000 hours in saline mist. Color White RAL 9016.

**Diffuser:** made by shockproof and self-extinguishing opal polycarbonate, UV resistant.

**Wiring:** includes 220-240V 50Hz control gear, non-flame propagating PVC HT 105° cables, double insulated. LED Salò can be installed in both concealed and outdoor circuits.

**According to standard:** EN60598-1, RG0 exempt from photo-biological risks in compliance with standard EN62471.

**Source:** LED SMD2835

**Led:** maintenance of minimum luminous flux to 80%: 50.000h (L80B10).

**Driver multipower** : included.

**IP degree:** IP65 certified by an external laboratory

# LED Salò

220-240V 50/60Hz   750°  **IK08** **IP65**

## LED Salò



**CRI 80**

**DRIVER INCLUDED**  
**MULTIPOWER**

+45  
C°  
-20

**FLICKER FREE**

**RG0**



	colour	W	Lm output	Optic	K	pcs	Kg	CELL		
	B	8-12-15	995-1610-2055	120°	3000	4000	001	1,350	SAL02CCT15W	<b>2CCT SWITCHABLE</b>
<b>DALI 2</b>	B	8-12-15	1060-1580-2070	120°	3000	4000	001	1,350	SAL02CCT15WD	<b>2CCT SWITCHABLE</b>



Funzione 2 CCT (3000K - 4000K) modificabile con interruttore a cursore.  
*Slide switch 2 CCT (3000K - 4000K) changeable function.*

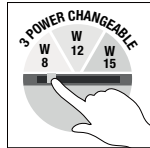

Funzione 3 POTENZE (8W -12W-15W) modificabile con interruttore a cursore.  
*Slide switch 3 POWER (8W -12W-15W) changeable function.*

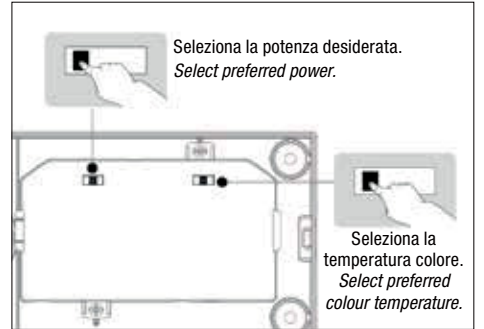

### Dati fotometrici - Photometric data

**8W**

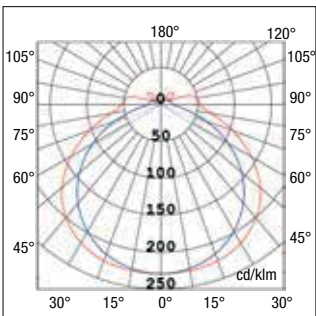

**12W**

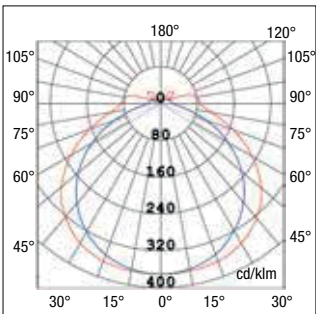

**15W**

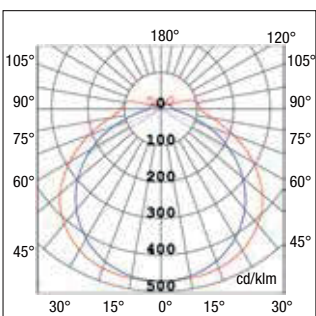

Outdoor

## LED Lodi Giù (installazione incasso o parete - built-in or wall installation)

Outdoor

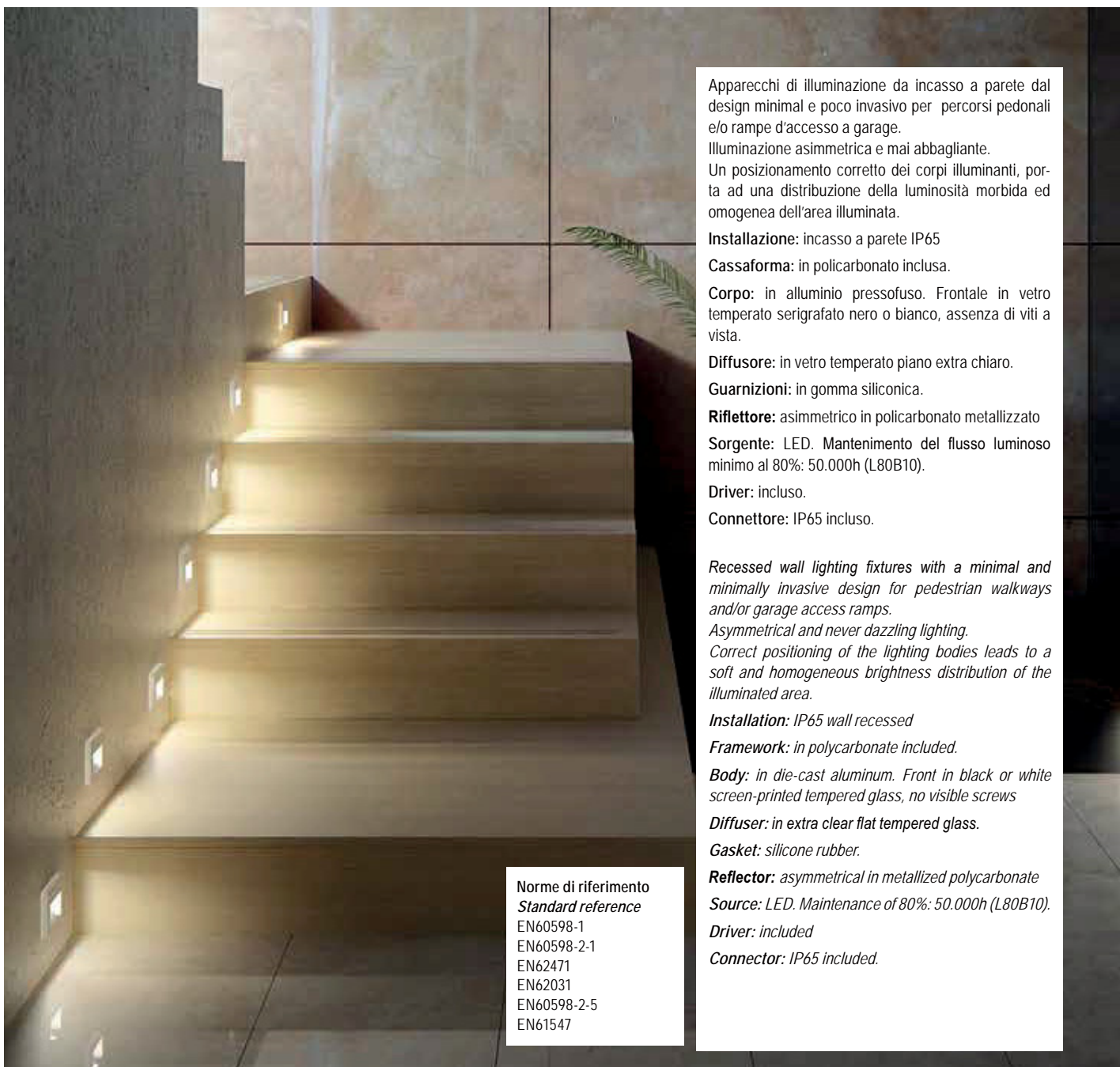

Norme di riferimento  
*Standard reference*  
EN60598-1  
EN60598-2-1  
EN62471  
EN62031  
EN60598-2-5  
EN61547

Apparecchi di illuminazione da incasso a parete dal design minimal e poco invasivo per percorsi pedonali e/o rampe d'accesso a garage.

Illuminazione asimmetrica e mai abbagliante.

Un posizionamento corretto dei corpi illuminanti, porta ad una distribuzione della luminosità morbida ed omogenea dell'area illuminata.

**Installazione:** incasso a parete IP65

**Cassaforma:** in policarbonato inclusa.

**Corpo:** in alluminio pressofuso. Frontale in vetro temperato serigrafato nero o bianco, assenza di viti a vista.

**Diffusore:** in vetro temperato piano extra chiaro.

**Guarnizioni:** in gomma siliconica.

**Riflettore:** asimmetrico in policarbonato metallizzato

**Sorgente:** LED. Mantenimento del flusso luminoso minimo al 80%: 50.000h (L80B10).

**Driver:** incluso.

**Connettore:** IP65 incluso.

*Recessed wall lighting fixtures with a minimal and minimally invasive design for pedestrian walkways and/or garage access ramps.*

*Asymmetrical and never dazzling lighting.*

*Correct positioning of the lighting bodies leads to a soft and homogeneous brightness distribution of the illuminated area.*

*Installation: IP65 wall recessed*

*Framework: in polycarbonate included.*

*Body: in die-cast aluminum. Front in black or white screen-printed tempered glass, no visible screws*

*Diffuser: in extra clear flat tempered glass.*

*Gasket: silicone rubber.*

*Reflector: asymmetrical in metallized polycarbonate*

*Source: LED. Maintenance of 80%: 50.000h (L80B10).*

*Driver: included*

*Connector: IP65 included.*



# LED Lodi Giù



220-240 Vac	110 Vac a richiesta on demand	50/60 Hz	IP65	IK06	CE
-------------	-------------------------------	----------	------	------	----

	850°		CRI >80	+40 C -20	
--	------	--	---------	-----------	--



colour	W	Optic	K	lm	pcs	Kg	CELL
<b>N</b>	1,5	ASY	3000	70	1	0,7	29091
<b>B</b>	1,5	ASY	3000	70	1	0,7	29090
<b>N</b>	2,5	ASY	3000	130	1	0,7	29093
<b>B</b>	2,5	ASY	3000	130	1	0,7	29092
<b>N</b>	3,5	ASY	3000	190	1	0,7	29095
<b>B</b>	3,5	ASY	3000	190	1	0,7	29094

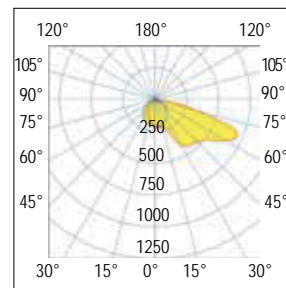
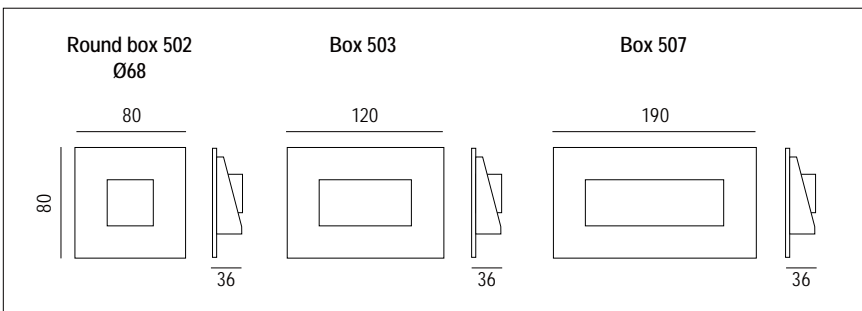

**ASY**  
Asimmetrica - Asymmetrical

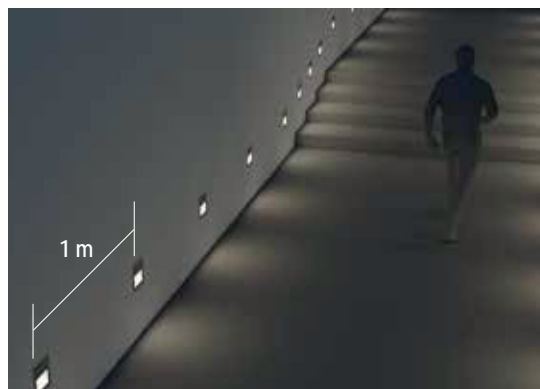
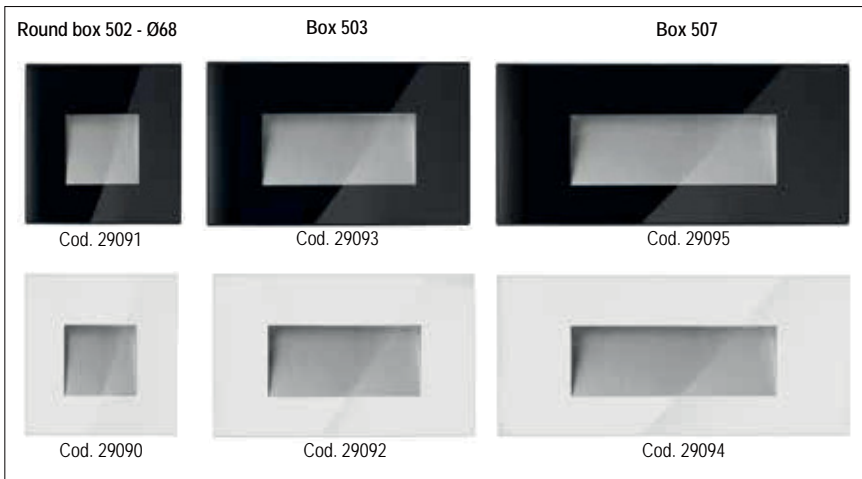

Outdoor

## Accessori NON inclusi - NOT included accessories

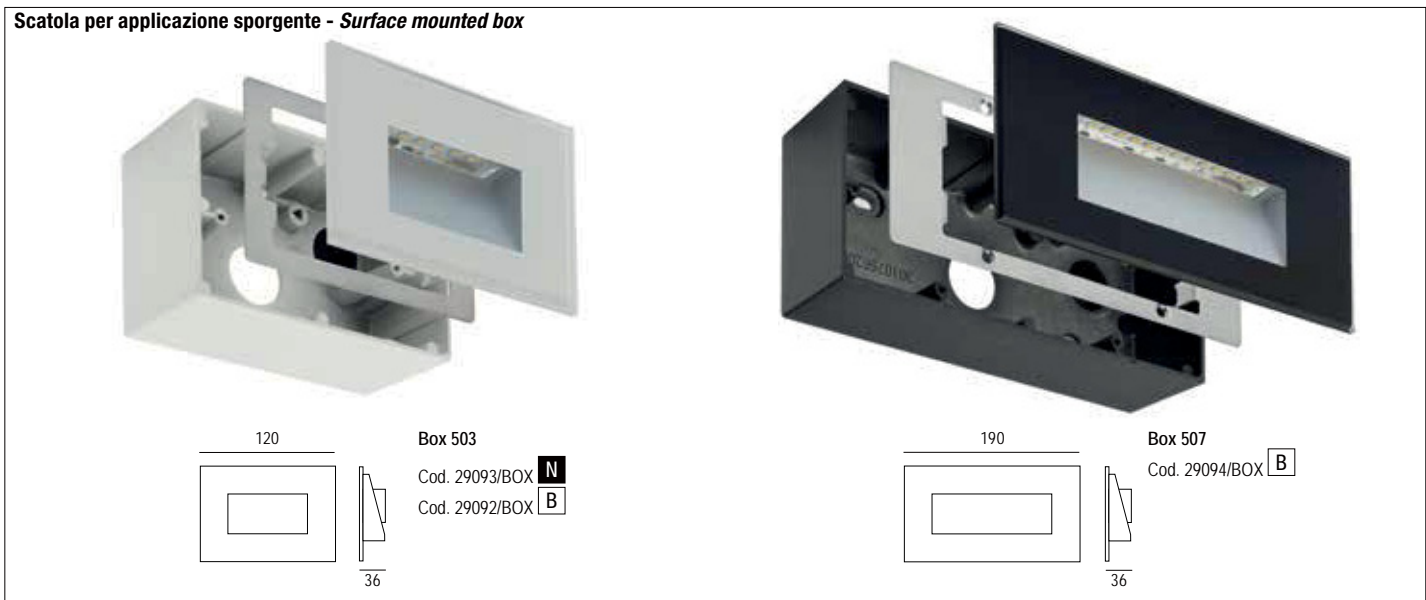

# LED Turbot

L'appliche LED Turbot ha un design su e giù con driver interno

**Corpo:** in alluminio pressofuso per un'eccellente dissipazione termica

**Verniciatura:** Nero RAL 9005 o Bianco RAL 9016 (anti corrosione e resistente agli agenti atmosferici)

**Diffusore:** policarbonato con rivestimento UV, resistente ai raggi UV.

**Installazione:** a plafone o parete sia per interno che per esterno

**Alimentazione:** inclusa

*Turbot LED wall light has an up and down design with internal driver*

**Body:** in die-cast aluminum for excellent heat dissipation

**Paint:** Black RAL 9005 or White RAL 9016 (corrosion and weather resistant)

**Diffuser:** UV coated polycarbonate, UV resistant.

**Installation:** surface or wall mounted for both indoor and outdoor

**Power supply:** included



100-240 Vac	50/60 Hz	IP65	IK10	+45 C° -20	
750°		CE	<b>DRIVER INCLUDED</b> 		

colour	W	Optic	K	Lm	pcs	Kg	CELL
<b>N</b>	8	180°	3000	600	1	0,42	RL08-8W-BL3K
<b>B</b>	8	180°	3000	600	1	0,42	RL08-8W-WH3K

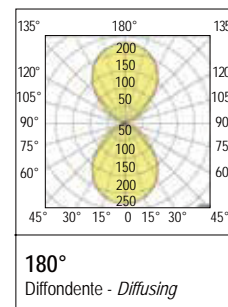
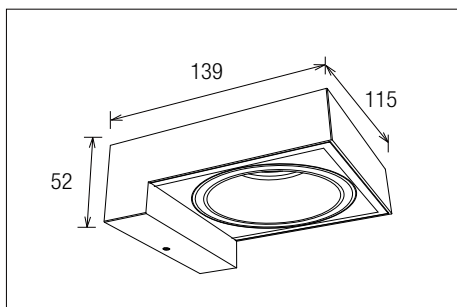

Outdoor



# LED Line Up

illuminazione che disegna l'architettura con fasci di luce mettendo in evidenza vuoti e pieni che ne enfatizzano la tridimensionalità degli spazi.

La luce interagendo con la materia crea ambienti nuovi che di giorno non esistono

Il corpo illuminante tende a scomparire per le sue ridotte dimensioni

**Installazione:** parete o soffitto

**Corpo e telaio:** schermo in polimetacrilato, corpo in alluminio pressofuso

**Driver:** incluso

*Light designs architecture with beams of light highlighting empty and full that emphasize the three-dimensionality of spaces.*

*Light interacting with matter creates new rooms that do not exist during the day*

*The lighting body tends to disappear thanks to its small sizes*

**Installation:** Wall and ceiling mounted

**Body and frame:** polymerised acrylic screen, die-cast aluminum body

**Driver:** driver included



220-240 Vac	50/60 Hz	IP55	IK08	CRI >80	+45 °C -20	
75° 		CE	<b>DRIVER INCLUDED</b> 			

colour	W	Optic	K	lm output	pcs	Kg	CELL
<b>N</b>	6	180°	4000	270	1	0,30	29140
<b>N</b>	6	180°	3000	270	1	0,30	29141

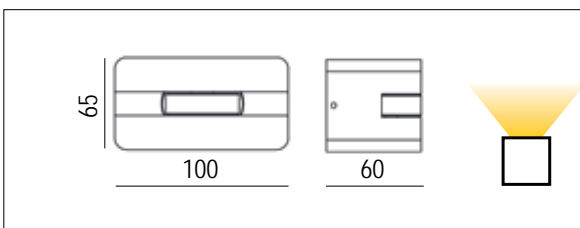

Outdoor

# LED Platax PLUS - LED Platax PLUS XL



Outdoor

## LED Platax PLUS - LED Platax XL

Plafoniera a LED stagna, idonea per applicazioni civili, commerciali, alberghiere.

**Corpo e cornice:** in nylon rinforzato con fibre di vetro, guarnizione in silicone, viti Torx anti-vandalo imperdibili.

**Diffusore:** in policarbonato opale, antiurto ed autoestinguente.

**Cablaggio:** composto da alimentazione 220-240V 50Hz, cavi in PVC HT 105° non propagante la fiamma, doppio isolamento. LED Platax è installabile sia per impianto sotto parete che esterno; fornita di serie con pressacavo in nylon PG13,5.

### Con sensore di movimento LED Platax Eye - LED Platax XL

Plafoniera a LED con sensore ad alta frequenza a 5,8 GHz. Colorazione neutra e gradevole, intensità e tonalità della luce invariate nel tempo. Sensore invisibile estremamente sensibile e silenzioso nell'accensione, con risposta immediata. È possibile regolare la sensibilità di rilevamento, la distanza di intervento, la soglia di luminosità ed il tempo di accensione.

Sorgente: LED LUMILEDS 3528

Mantenimento del flusso luminoso minimo al 80% - 80.000h (L80B20).

**Norme di riferimento:** EN60598-1, EN60598.2.1, EN62471, EN62031.

Nessun rischio fotobiologico, RGO gruppo di rischio esente (EN62471).

**Grado IP:** IP65 certificato da laboratorio accreditato

**Prodotto conforme alle direttive:**  

## LED Platax Plus - LED Platax XL

Compact waterproof LED fitting suitable for civil, commercial, hotel applications, etc.

**Body and frame:** made by nylon reinforced with glass fibres, silicone gasket, non-loosening Torx screws.

**Diffuser:** made by shockproof and self-extinguishing opal polycarbonate.

**Wiring:** includes 220-240V 50Hz control gear, non-flame propagating PVC HT 105° cables, double insulated. LED Platax can be installed in both concealed and outdoor circuits; supplied with nylon cable gland RG13,5.

### With motion sensor LED Platax Eye - LED Platax XL

Fitting with 5.8 GHz high-frequency sensor with neutral and pleasant colour, unaltered light intensity over time, extremely sensitive invisible sensor and silent switching-on, with instant response. The detection sensitivity, intervention distance, luminosity threshold and lighting time can be adjusted.

Source: LED LUMILEDS 3528

Maintenance of minimum luminous flux to 80% - 80.000h (L80B20).

**Reference standards:** EN60598-1, EN60598.2.1, EN62471, EN62031.

No risk of photobiological damage, RGO group (EN62471).

**IP degre:** IP65 certified by an external laboratory

**In compliance with the directives:**  

## LED PLATAX PLUS - Accessori - Accessories

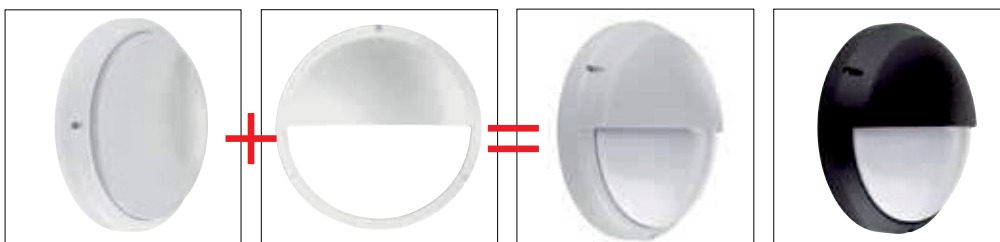

**B** Cod. CO3001.100 - Ø 280mm (Platax plus) Visiera Nylon - Nylon visor

**N** Cod. CO3002.100 - Ø 280mm (Platax plus) Visiera Nylon - Nylon visor

## Dati fotometrici - Photometric data

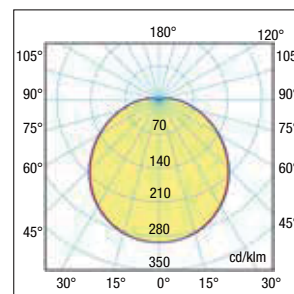



Outdoor

**Driver Platax Plus - settaggio di fabbrica - Platax Plus Driver - Factory Settings**



Led driver (4 poli Dip-Switch) permette di selezionare la potenza desiderata (1-2-3-4) e scegliere il funzionamento necessario.

LED Driver (4 pole Dip-switches) allows you to select the desired power (1-2-3-4) and to select the required connection.

Impostazione standard di fabbrica  
Driver Standard factory setting



Potenza Power	Lm Output	mA
Watt	Lm	mA
10	750	500
15	1150	650
20	1600	700

# LED Platax PLUS - XL

220-240V 50/60Hz **IK09** **IP65**

## Led Platax PLUS multipotenza



ø280 100

Outdoor

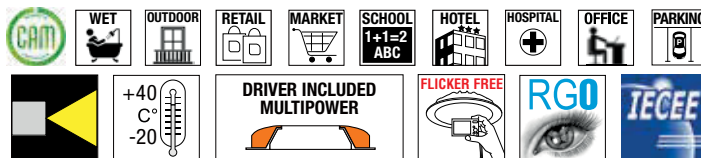

### LED Platax Plus

colour	W	V	Lm output	K	pcs	Kg	CELL
B	11	220-240	1000	4000	006	0,850	555523.0101
B	16	220-240	1400	3000	006	0,850	555638.0101
B	16	220-240	1400	4000	006	0,850	555611.0101

colour	W	V	Lm output	K	pcs	Kg	CELL
B	max 20	220-240	max 1600	3000	006	0,850	555637.PLUS
B	max 20	220-240	max 1600	4000	006	0,850	555523.PLUS
N	max 20	220-240	max 1600	3000	006	0,850	555538.PLUS
N	max 20	220-240	max 1600	4000	006	0,850	555524.PLUS
B	max 20	220-240	max 1600	3000	006	0,850	555637.PLUSDA
B	max 20	220-240	max 1600	4000	006	0,850	555523.PLUSDA

### LED Platax Plus EYE

colour	W	V	Lm output	K	pcs	Kg	CELL
B	max 20	220-240	max 1600	3000	006	0,850	555540.PLUS
B	max 20	220-240	max 1600	4000	006	0,850	555613.PLUS
N	max 20	220-240	max 1600	3000	006	0,850	555540.PLUSNE
N	max 20	220-240	max 1600	4000	006	0,850	555613.PLUSNE

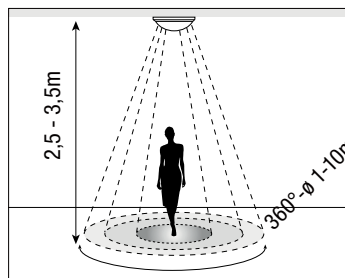
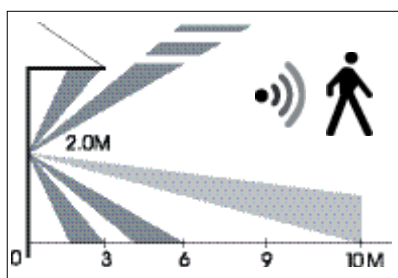

## Led Platax multipower Emer

### Caratteristiche tecniche

(A) Linea permanente per la ricarica delle batterie e il funzionamento in emergenza.

(B) Linea interrotta.

(D) Il gruppo batterie viene fornito non connesso per non danneggiare gli accumulatori.

Eseguire la connessione durante l'installazione.

### Technical features

(A) Permanent mains supply (battery recharge and mains failure detection).

(B) Non permanent mains.

(D) The battery pack comes not connected to the circuit.

Connect together male and female connectors.

colour	W	V	K	Lm Output	Flux Lm	Kg	CELL-E
B	max 20	220-240	3000	max 1600	15%	1,160	555637.PLUSEM
B	max 20	220-240	4000	max 1600	15%	1,160	555523.PLUSEM
N	max 20	220-240	3000	max 1600	15%	1,160	555568.PLUSEM
N	max 20	220-240	4000	max 1600	15%	1,160	555524.PLUSEM

### LED Platax MULTIPOWER EMER + EYE

colour	W	V	K	Lm Output	Flux Lm	Kg	CELL-E
B	max 20	220-240	3000	max 1600	15%	1,160	555637PLUSEMS
B	max 20	220-240	4000	max 1600	15%	1,160	555523PLUSEMS

**Led Platax XL**

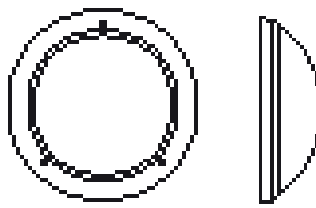

ø 380 100

**LED Platax XL**

	colour	W	V	Lm output	K	pcs	Kg	CELL
	B	22	220-240	2100	3000	006	1,350	555639.0101
	B	22	220-240	2100	4000	006	1,350	555618.0101
	<b>DALI 2</b> B	22	220-240	2100	3000	006	1,350	555639.0101DA
	<b>DALI 2</b> B	22	220-240	2100	4000	006	1,350	555618.0101DA
	N	22	220-240	2100	3000	006	1,350	555620.0101
	N	22	220-240	2100	4000	006	1,350	555619.0101
	G	22	220-240	2100	4000	006	1,350	555625.0101
	B	30	220-240	3000	3000	006	1,350	555639.0102
	B	30	220-240	3000	4000	006	1,350	555618.0102
	N	30	220-240	3000	3000	006	1,350	555620.0102
	G	30	220-240	3000	4000	006	1,350	555625.0102

**LED Platax XL EYE**

	colour	W	V	Lm output	K	pcs	Kg	CELL
	B	22	220-240	2100	3000	006	0,915	555641.0101
	B	22	220-240	2100	4000	006	0,915	555622.0101
	N	22	220-240	2100	3000	006	0,915	555623.0101
	G	22	220-240	2100	4000	006	0,915	555624.0101
	B	30	220-240	3000	3000	006	1,400	555641.0102
	B	30	220-240	3000	4000	006	1,400	555622.0102
	N	30	220-240	3000	3000	006	1,400	555623.0102
	G	30	220-240	3000	4000	006	1,400	555624.0102

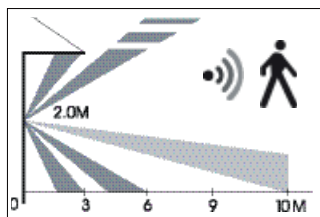

**LED Platax XL Emer**

**LED Platax XL EMER**

	colour	W	V	Lm output	K	pcs	Kg	CELL-E
	B	22	220-240	2100	3000	006	2,000	555639.EMER
	B	22	220-240	2100	4000	006	2,000	555618.EMER
	N	22	220-240	2100	3000	006	2,000	555620.EMER
	B	30	220-240	3000	3000	006	2,000	555639.EMER2
	B	30	220-240	3000	4000	006	2,000	555618.EMER2
	N	30	220-240	3000	3000	006	2,000	555620.EMER2
	<b>DALI 2</b> B	22	220-240	2100	3000	006	2,000	555639.DAEMER
	<b>DALI 2</b> B	22	220-240	2100	4000	006	2,000	555618.DAEMER

**LED Platax XL EMER + EYE**

	colour	W	V	Lm output	K	pcs	Kg	CELL-E
	B	22	220-240	2100	3000	006	2,000	555641.EMER
	B	22	220-240	2100	4000	006	2,000	555622.EMER
	N	22	220-240	2100	3000	006	2,000	555623.EMER
	B	30	220-240	3000	3000	006	2,000	555641.EMER2
	B	30	220-240	3000	4000	006	2,000	555622.EMER2
	N	30	220-240	3000	3000	006	2,000	555623.EMER2

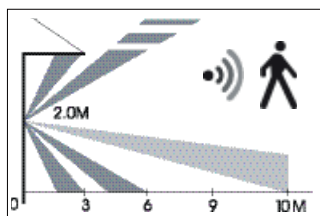

È possibile regolare la sensibilità di rilevamento, la distanza di intervento, la soglia di luminosità ed il tempo di accensione.  
*The detection sensitivity, intervention distance, luminosity threshold and lighting time can be adjusted.*

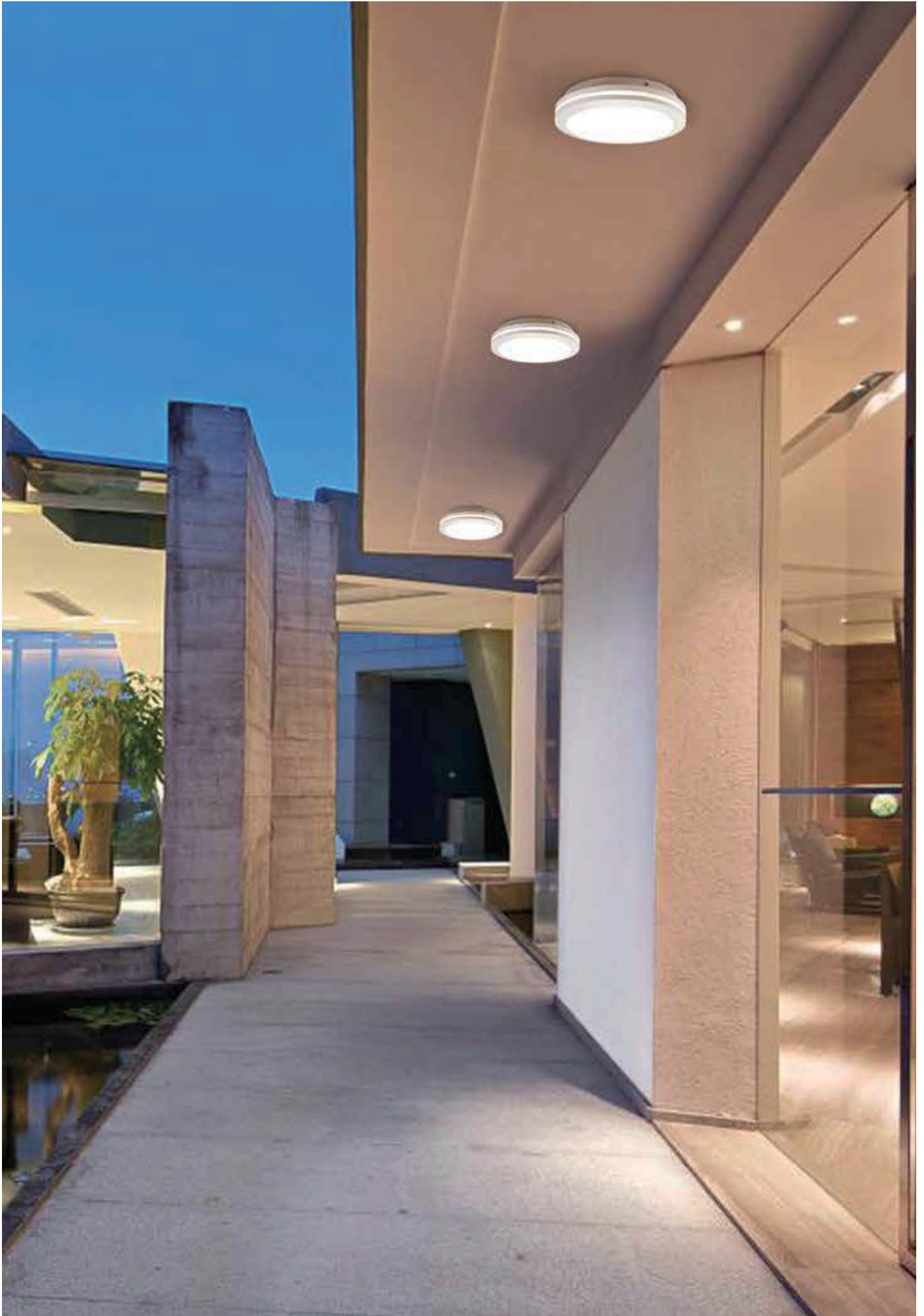



## Apparecchi in emergenza A RICHIESTA - ON DEMAND *Emergency wired luminaires*

### Apparecchi di illuminazione cablati in emergenza

Relco nella politica di offrire un servizio migliore alla clientela, ha deciso di utilizzare nelle lampade stgne versioni **EMERGENZA STANDARD (solo LED che segnala presenza rete) oppure AUTOTEST per la segnalazione di eventuali anomalie. Vedi colore del LED nella tabella sottostante**

Le norme europee EN 1838, EN 60598-2-22, relative ai sistemi di illuminazione di emergenza, impongono che periodicamente, siano effettuati dei test per verificare sia il funzionamento sia l'efficienza (durata in emergenza) degli apparecchi di illuminazione che svolgono anche la funzione di illuminazione di emergenza. Questo costringe i manutentori dell'impianto ad interrompere la linea di alimentazione ed effettuare test con cadenza settimanale (test funzionale), e con cadenza trimestrale o annuale (test di autonomia). Con i nostri kit di emergenza con autotest (conformi alla normativa europea EN 62034) queste prove vengono svolte automaticamente con cadenza programmabile in fase di installazione. Inoltre il nostro inverter analizza i tempi di normale accensione e spegnimento dell'apparecchio ed effettua (qualora possibile) i test nelle ore di assenza delle persone.

Eventuali anomalie sono segnalate tramite un indicatore (led) rosso verde.

A partire dal colore della segnalazione è possibile stabilire in maniera univoca gli eventuali problemi di funzionamento come evidenziato nella tabella seguente.

### Emergency wired lighting fixtures

Relco, in its policy of offering a better service to customers, has decided to use **STANDARD EMERGENCY versions (only LED that signals network presence) or AUTOTEST versions for signaling any anomalies in its emergency lamps. See LED color in the table below**

The European standards EN 1838, EN 60598-2-22, relating to emergency lighting systems, require that tests be periodically carried out to verify both the functioning and the efficiency (duration in emergency) of the lighting fixtures which also the emergency lighting function. This forces the system maintainers to interrupt the power supply line and carry out tests on a weekly basis (functional test), and on a quarterly or annual basis (autonomy test).

With our emergency kits with self-test (complying with European standard EN 62034) these tests are carried out automatically with a programmable cadence during installation. Furthermore, our inverter analyzes the normal switching on and off times of the appliance and carries out (where possible) the tests in the hours when people are absent.

Any anomalies are signaled by a red-green indicator (led). Starting from the color of the signal, it is possible to unequivocally establish any functioning problems as shown in the following table.

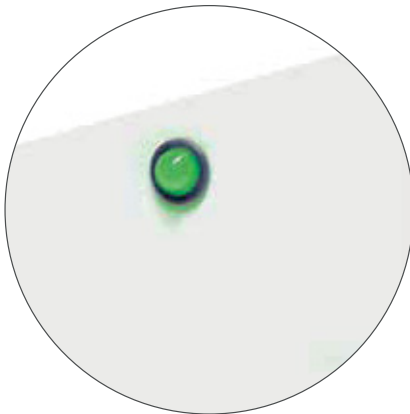

Colore LED - LED indication		Stato - Status
	Verde fisso - Permanent Green	Batteria carica o in carica - Battery charge or charging
	Verde lampeggiante - Flashing Green	Funzione TEST avviata - TEST in progress
	Verde lampeggiante lento (1s ON - 1s OFF) Slow flashing green (1s ON - 1s OFF)	TEST di autonomia avviato Autonomy TEST in progress
	Rosso fisso - Permanent Red	Lampada guasta - Lamp failure
	Rosso lampeggio veloce (0,1s ON - 0,1s OFF) Fast flashing Red (0,1s ON - 0,1s OFF)	Guasto circuito di ricarica - Charging failure
	Lampeggio Rosso lento (1s ON - 1s OFF) Slow flashing Red (1s ON - 1s OFF)	Batteria guasta - Battery failure
	Verde e Rosso OFF - Green and Red OFF	Emergenza ON - Emergency ON

## Serie Platax Plus + Luna Piena

**Nuovo circuito LED studiato per garantire una perfetta omogeneità della diffusione luminosa del corpo lampada**  
**New LED circuit designed to ensure perfect homogeneity of the light diffusion of the lamp body**



**CRI 90**

Outdoor



# LED Giotto



Outdoor

### LED Giotto

Plafoniera a LED stagna, pratica e semplice, grazie al montaggio ad incastro del diffusore e della cornice senza l'utilizzo di viti, idonea per applicazioni civili, commerciali, alberghiere.

**Corpo:** in nylon rinforzato con fibre di vetro, guarnizione in silicone.

**Cornice:** inclusa in colore bianco RAL 9016, a richiesta nera RAL 9005 e colore effetto legno.

**Diffusore:** in policarbonato opale, antiurto ed autoestinguente.

**Cablaggio:** composto da alimentazione 220-240V 50Hz, cavi in PVC HT 105° non propagante la fiamma, doppio isolamento. LED Giotto è installabile sia per impianto sotto parete che esterno; fornita di serie con pressacavo in nylon PG13,5.

### Con sensore di movimento LED Giotto Eye

Plafoniera a LED con sensore ad alta frequenza a 5,8 GHz. Colorazione neutra e gradevole, intensità e tonalità della luce invariate nel tempo. Sensore invisibile estremamente sensibile e silenzioso nell'accensione, con risposta immediata. È possibile regolare la sensibilità di rilevamento, la distanza di intervento, la soglia di luminosità ed il tempo di accensione.

Sorgente: LED LUMILEDS 3528

Mantenimento del flusso luminoso minimo al 80% - 80.000h (L80B20).

**Norme di riferimento:** EN60598-1, EN60598.2.1, EN62471, EN62031.

Nessun rischio fotobiologico, RGO gruppo di rischio esente (EN62471).

**Grado IP:** IP65 certificato da laboratorio accreditato

**Prodotto conforme alle direttive:**

### LED Giotto

Waterproof LED ceiling light, practical and simple, thanks to the interlocking assembly of the diffuser and the frame without the use of screws, suitable for civil, commercial and hotel applications.

**Body:** made by nylon reinforced with glass fibres, silicone gasket.

**Frame:** included in white RAL 9016, black RAL 9005 and wood effect color on request.

**Diffuser:** made by shockproof and self-extinguishing opal polycarbonate.

**Wiring:** includes 220-240V 50Hz control gear, non-flame propagating PVC HT 105° cables, double insulated. LED Giotto can be installed in both concealed and outdoor circuits; supplied with nylon cable gland RG13,5.

### With motion sensor LED Giotto Eye

Fitting with 5.8 GHz high-frequency sensor with neutral and pleasant colour, unaltered light intensity over time, extremely sensitive invisible sensor and silent switching-on, with instant response. The detection sensitivity, intervention distance, luminosity threshold and lighting time can be adjusted.

Source: LED LUMILEDS 3528

Maintenance of minimum luminous flux to 80% - 80.000h (L80B20).

**Reference standards:** EN60598-1, EN60598.2.1, EN62471, EN62031.

No risk of photobiological damage, RGO group (EN62471).

**IP degre:** IP65 certified by an external laboratory

**In compliance with the directives:**

### Dati fotometrici - Photometric data

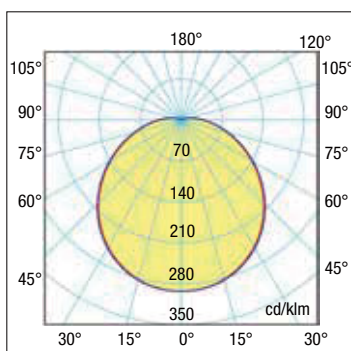

### Facilità di montaggio, senza viti! - Easy assembly, no screws!

Fissare la base al soffitto/plafone.  
Fix the base to the ceiling/ceiling.



Montare il diffusore ad incastro.  
Mount the interlocking light diffuser.



Montare la cornice ad incastro.  
Assemble the interlocking frame.



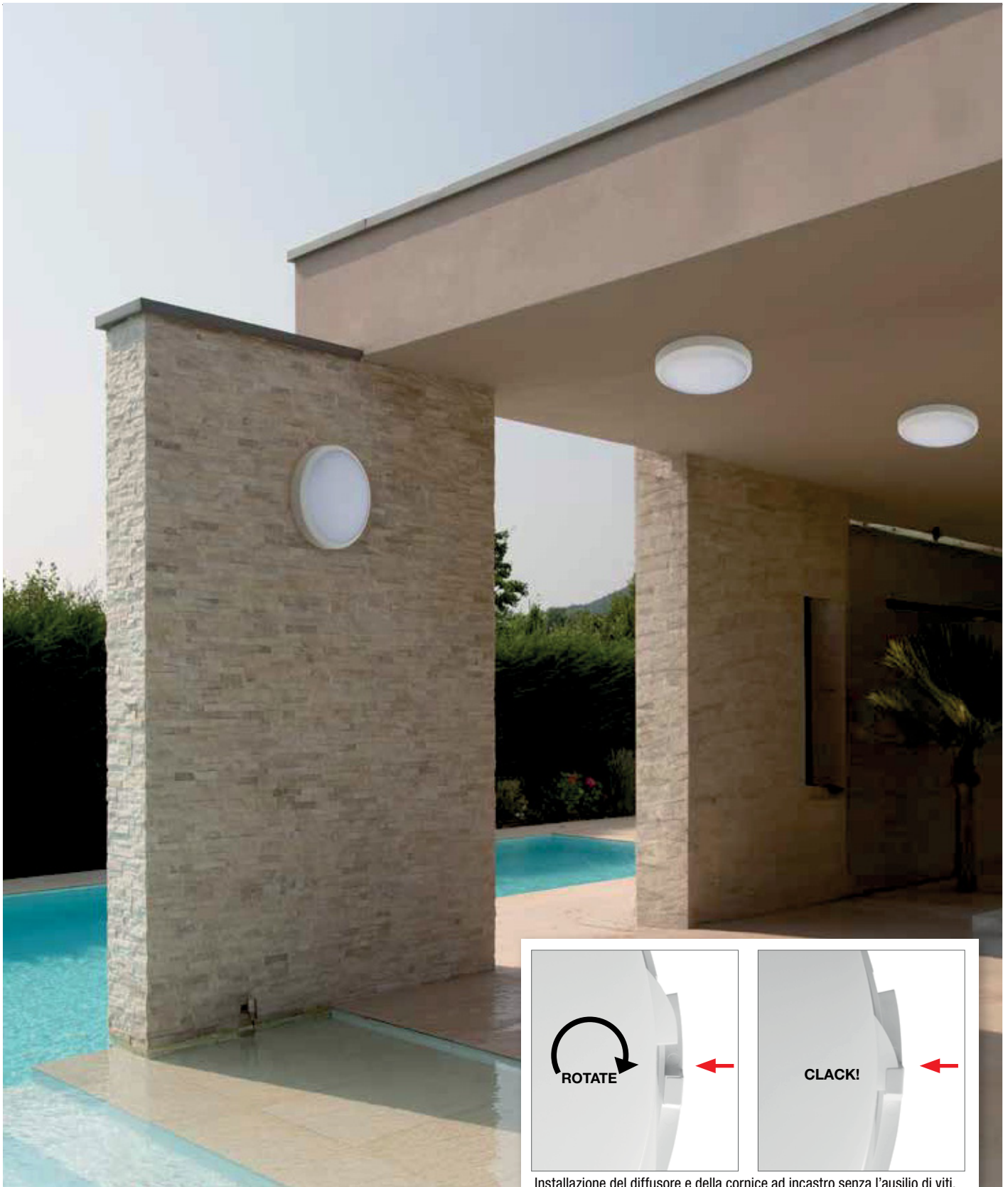

Outdoor

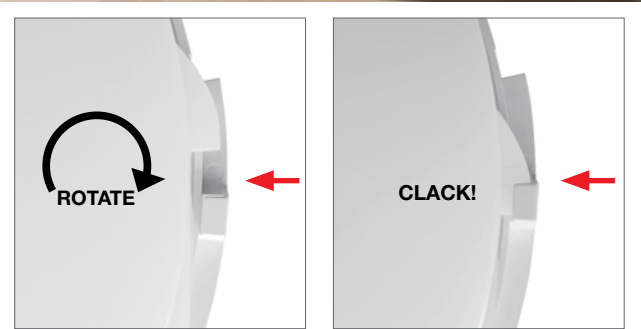

Installazione del diffusore e della cornice ad incastro senza l'ausilio di viti.  
*Installation of the speaker and the interlocking frame without the use of screws.*

### Settaggio di fabbrica Driver - Driver Factory Settings



Led driver (4 poli Dip-Switch) permette di selezionare la potenza desiderata (vedi tabella) e scegliere il funzionamento necessario.

*LED Driver (4 pole Dip-switches) allows you to select the desired power (see table) and to select the required connection.*

 Impostazione standard di fabbrica  
*Driver Standard factory setting*



Potenza Power	Lm Output	mA
Watt	Lm	mA
12	1320	300
16	1760	400
20	2200	500
26	2860	650
30	3300	750

220-240V 50/60Hz

IK10 IP65

**Led Giotto multipotenza**



**CRI 90**



+40  
C°  
-20

**DRIVER INCLUDED  
MULTIPOWER**

**FLICKER FREE**

**RG0**

**TECEE**

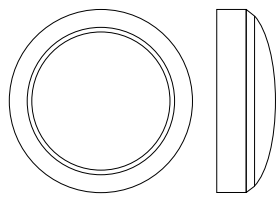

ø 322 65

colour	W max	V	Lm/W	K	pcs	Kg	CELL
B	30	220-240	110	3000	006	1,350	GIOTTO303K
B	30	220-240	110	4000	006	1,350	GIOTTO304K
<b>DALI 2</b> B	30	220-240	110	3000	006	1,350	GIOTTO303KDA
<b>DALI 2</b> B	30	220-240	110	4000	006	1,350	GIOTTO304KDA

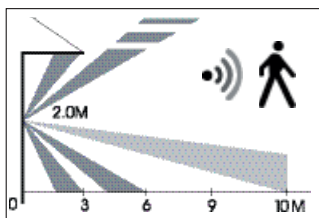

**LED Giotto EYE**

colour	W max	V	Lm/W	K	pcs	Kg	CELL
B	30	220-240	110	3000	006	1,350	GIOTTO303KEYE
B	30	220-240	110	4000	006	1,350	GIOTTO304KEYE

Outdoor

**LED Giotto EMER**



colour	W max	V	Lm/W	K	pcs	Kg	CELL-E
B	30	220-240	110	3000	006	2,000	GIOTTO303KEME
B	30	220-240	110	4000	006	2,000	GIOTTO304KEME

**STANDARD, con cornice bianca inclusa**  
*STANDARD, with white frame included*

**ACCESSORI a richiesta, cornici per Giotto da ordinare a parte**  
*ACCESSORIES on request, frames for Giotto to be ordered separately*



Base con cornice bianca - *Base with white frame*  
cod. **GIOTTO30...**  
cod. **GIOTTO30...EYE**  
cod. **GIOTTO30...EME**



Cornice Nera / *Black Frame*  
cod. **CORGIOTT0BL**



Cornice color Legno / *Wood-colored frame*  
cod. **CORGIOTT0WO**

## LED Luna piena



Outdoor

# LED Luna piena

1-10Vdc



## LED Luna piena multipotenza

Plafoniera a LED stagna, idonea per applicazioni civili, commerciali, alberghiere.

**Corpo e cornice:** alluminio pressofuso laccato bianco, grigio e nero di serie, a richiesta versione oro, guarnizione in silicone, viti Torx anti-vandalismo imperdibili.

**Verniciatura:** di tipo poliestere eseguita a polvere, resistente agli agenti atmosferici e alla corrosione e garantita per 1.000 ore in nebbia salina.

Colore Nero RAL 9005, bianco RAL9010 o grigio RAL 9007

**Diffusore:** in policarbonato opale, antiurto ed autoestinguente resistente agli UV.

**Cablaggio:** composto da alimentazione 220-240V 50Hz, cavi in PVC HT 105° non propagante la fiamma, doppio isolamento. LED Luna piena è installabile sia per impianto sotto parete che esterno.

## LED Luna piena multipotenza - Con sensore di movimento

Plafoniera a LED con sensore ad alta frequenza a 5,8 GHz. Colorazione neutra e gradevole, intensità e tonalità della luce invariate nel tempo. Sensore invisibile estremamente sensibile e silenzioso nell'accensione, con risposta immediata. È possibile regolare la sensibilità di rilevamento, la distanza di intervento, la soglia di luminosità ed il tempo di accensione.

## Caratteristiche tecniche LED Luna piena EMERGENZA SA

Plafoniera Stagna LED con Emergenza integrata.

Il Gruppo di Emergenza interviene automaticamente in caso di interruzione della rete elettrica.

- Flusso luminoso costante in emergenza.
- Spegnimento automatico per sottotensione di batteria.
- Batteria a 3 elementi 3,6 V, 4 A/h.
- Tempo di ricarica massimo 24 ore
- Autonomia 3h, con flusso al 15%.
- Spia LED di attivazione del circuito di ricarica.

**Conforme alla norma:** EN60598-1, RG0 nessun rischio fotobiologico ai fini della norma EN62471.

**Sorgente:** LED LUMILEDS 3528

**Led:** mantenimento del flusso luminoso minimo al 80%: 50.000h (L80B10).

**Driver multipotenza** : incluso.

**Grado IP:** IP65 certificato da laboratorio accreditato

## LED Luna piena multipower

Compact waterproof LED fitting suitable for civil, commercial, hotel applications, etc.

**Body and frame:** white, gray and black lacquered die-cast aluminum as standard, on request gold, silicone gasket, non-loosening Torx screws.

**Painting:** polyester powder type, resistant to atmospheric agents and corrosion and guaranteed for 1,000 hours in saline mist.

Color Black RAL 9005, white RAL9010 or grey RAL 9007

**Diffuser:** made by shockproof and self-extinguishing opal polycarbonate, UV resistant.

**Wiring:** includes 220-240V 50Hz control gear, non-flame propagating PVC HT 105° cables, double insulated. LED Luna piena can be installed in both concealed and outdoor circuits.

## LED Luna piena Eye - with motion sensor

Fitting with 5.8 GHz high-frequency sensor with neutral and pleasant colour, unaltered light intensity over time, extremely sensitive invisible sensor and silent switching-on, with instant response. The detection sensitivity, intervention distance, luminosity threshold and lighting time can be adjusted.

## LED Luna piena Emergency SA Technical features

Water Proof LED fitting with integrated Emergency Kit integrated.

Emergency Kit turns on when power is cut.

- Non stop light flow during emergency.

- Under voltage lockout.

- Battery with 3 elements 3,6V, 4 A/h included.

- Charging time max 24 hours.

- Autonomy 3h with flux 15%.

- LED Monitor to indicate mains-on conditions.

**According to standard:** EN60598-1, RG0 exempt from photo-biological risks in compliance with standard EN62471.

**Source:** LED LUMILEDS 3528

**Led:** maintenance of minimum luminous flux to 80%: 50.000h (L80B10).

**Driver multipower** : included.

**IP degree:** IP65 certified by an external laboratory

Outdoor



**A richiesta:** versione 2700K, 3000K e 6000K

**On demand:** 2700K, 3000K and 6000K versions

## Esempio di installazione in linea continua - Continuous line installation example

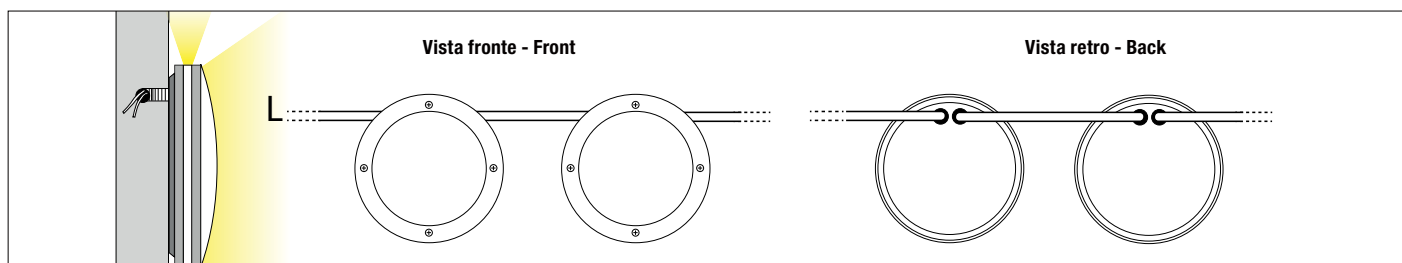

# LED Luna piena max 30W

220-240V 50/60Hz   850°  

## LED Luna piena multipower

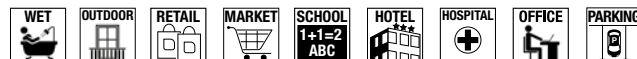
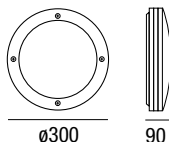

**CRI 90**



colour	W	V	Lm output	K	pcs	Kg	CELL
B	20	220-240	1800	4000	006	1,900	28922/BASIC
B	25	220-240	2300	4000	006	1,900	28922-25BASIC
B	30	220-240	2800	4000	006	1,900	28922-30BASIC

## LED Luna piena max 20W

colour	W	V	Lm output	K	pcs	Kg	CELL
N	max 20	220-240	1800	4000	006	1,900	28920
G	max 20	220-240	1800	4000	006	1,900	28921

## LED Luna piena max 20W EYE

colour	W	V	Lm output	K	pcs	Kg	CELL
B	max 20	220-240	1800	4000	006	1,900	28925
N	max 20	220-240	1800	4000	006	1,900	28923
G	max 20	220-240	1800	4000	006	1,900	28924

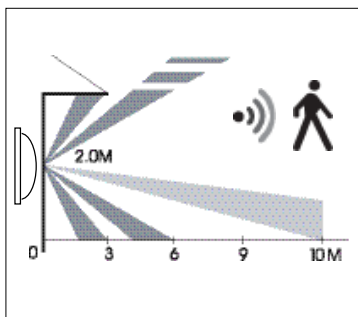

È possibile regolare la sensibilità di rilevamento, la distanza di intervento, la soglia di luminosità ed il tempo di accensione.

*The detection sensitivity, intervention distance, luminosity threshold and lighting time can be adjusted.*

Power	Lm Output	mA
Watt	Lm	mA
10	950	450
15	1450	650
20	1800	900





Impostazione standard di fabbrica  
Driver Standard factory setting

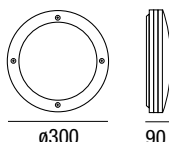

Outdoor

## LED Luna piena Emer



colour	W	V	K	Lm Output	Flux Lm	Kg	CELL-E
B 	20	220-240	4000	1800	15%	2,100	28928
N 	20	220-240	4000	1800	15%	2,100	28926
G 	20	220-240	4000	1800	15%	2,100	28927
B 	30	220-240	2800	4000	006	1,900	28922-30BASICE

## LED Luna Piena EMER EYE

colour	W	V	K	Lm Output	Flux Lm	Kg	CELL-E
B 	20	220-240	4000	1800	15%	2,100	28928/EYE

# BASIC series LED Kamaleon, IP65



## LED Kamaleon 6 lampade in una.

Plafoniera a LED stagna, idonea per applicazioni civili, commerciali, alberghiere, disponibile in 2 misure ø250mm e ø350mm, con possibilità di scelta tra tre diverse temperature di colore, bianco caldo, bianco neutro o bianco freddo e con scelta della potenza tra 12W, 15W, 18W per la misura più contenuta e 18W, 24W o 30W per la misura più grande.

Corpo e cornice: in nylon rinforzato con fibre di vetro, guarnizione in silicone, viti Torx anti-vandalismo imperdibili.

Diffusore: in policarbonato opale, antiurto ed autoestinguente.

Cablaggio: composto da alimentazione 220-240V 50Hz, cavi in PVC HT 105° non propagante la fiamma, doppio isolamento. Installabile sia per impianto sotto parete che esterno; fornita di serie con pressacavo in nylon PG13,5.

## Kamaleon LED 6 lamps in one.

Watertight LED ceiling light, suitable for civil, commercial, hotel applications, available in 2 sizes ø250mm and ø350mm, with the possibility of choosing between three different color temperatures, warm white, neutral white or cold white and with a choice of power between 12W, 15W, 18W for the smallest size and 18W, 24W or 30W for the largest size.

Body and frame: in nylon reinforced with glass fibers, silicone gasket, captive vandal-proof Torx screws.

Diffuser: in opal polycarbonate, shockproof and self-extinguishing.

Wiring: composed of 220-240V 50Hz power supply, non-flame propagating 105 ° PVC cables, double insulation. Can be installed both for under-wall and external systems; supplied as standard with PG13.5 nylon cable gland.



**[6 in 1]**

**[6 in 1]**

**Cambia la cornice con un semplice click! scegli tra 3 colori diversi grigio, nero e bianco (da ordinare a parte).**  
**Change the frame with a simple click! choose between 3 different colors gray, black and white (on demand).**

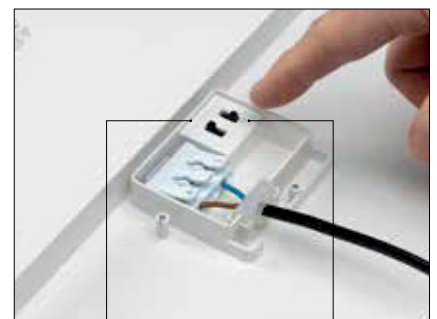
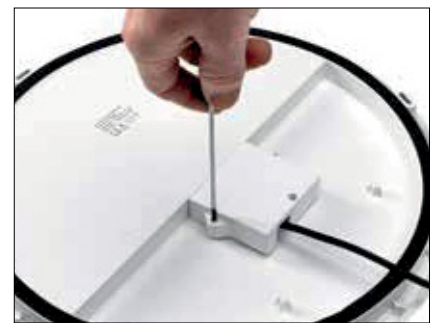
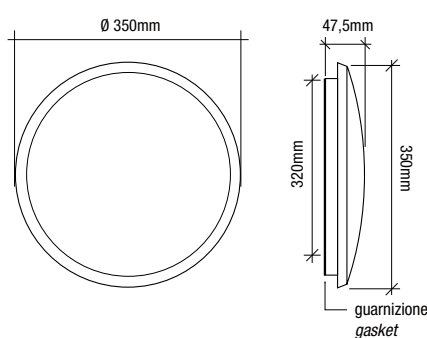
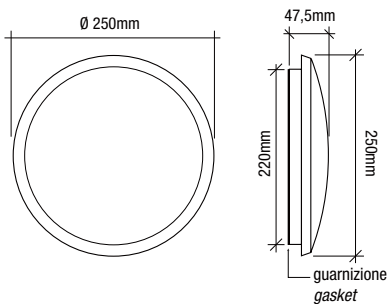

### LED Kamaleon ø 250mm

Color	Code	W	K
□	2591	12/15/18	3000
			4000
			6000

Sorgente Source SMD **LED**

Flusso luminoso max. Lighting output max. 1200/1500/1800 Lm

Peso kg weight kg 0,75



220-240V 50/60Hz DRIVER INCLUDED

### LED Kamaleon ø 350mm

Color	Code	W	K
□	2592	18/24/30	3000
			4000
			6000

Sorgente Source SMD **LED**

Flusso luminoso max. Lighting output max. 1800/2400/3000 Lm

Peso kg weight kg 0,85



220-240V 50/60Hz DRIVER INCLUDED

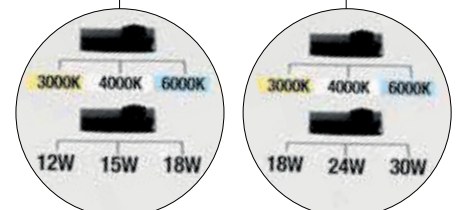



Outdoor

ACCESSORIO Cornice per Kamaleon NON INCLUSA  
Kamaleon Frame ACCESSORY NOT INCLUDED



+



Corpo lampada - Body lamp

Color



Code	Ø mm
2591	250
2592	350

Cornice - Frame

Color



Code	Ø mm
2591/W	250
2592/W	350

Cornice - Frame

Color



Code	Ø mm
2591/G	250
2592/G	350

Cornice - Frame

Color



Code	Ø mm
2591/B	250
2592/B	350

## Plafoniere per esterno *Outdoor ceiling lights*

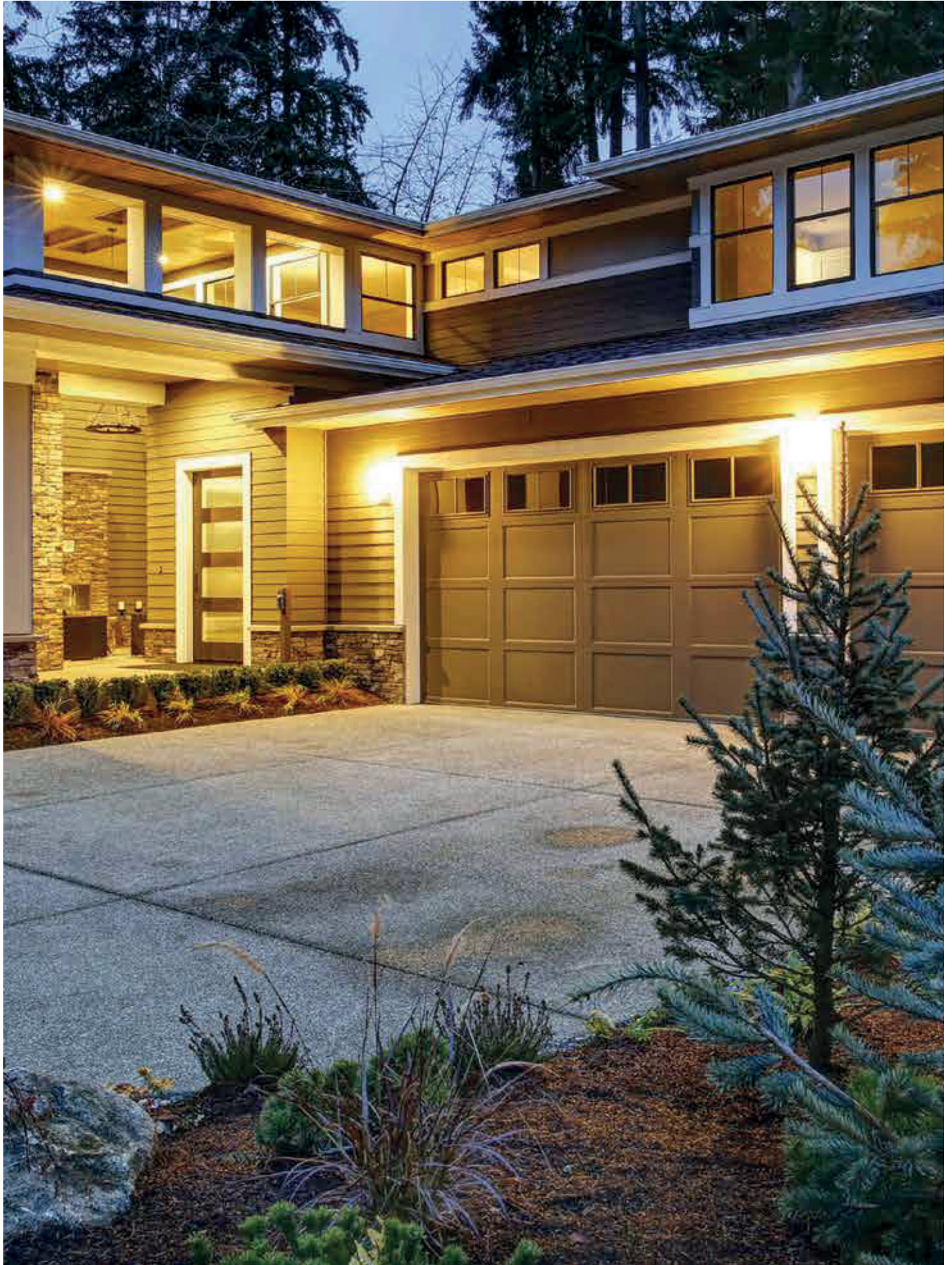

Outdoor

# Plafoniere per esterno con attacco E27

## Outdoor ceiling lights with E27 socket

Termoplastico + Vetro - *Thermoplastic + Glass*

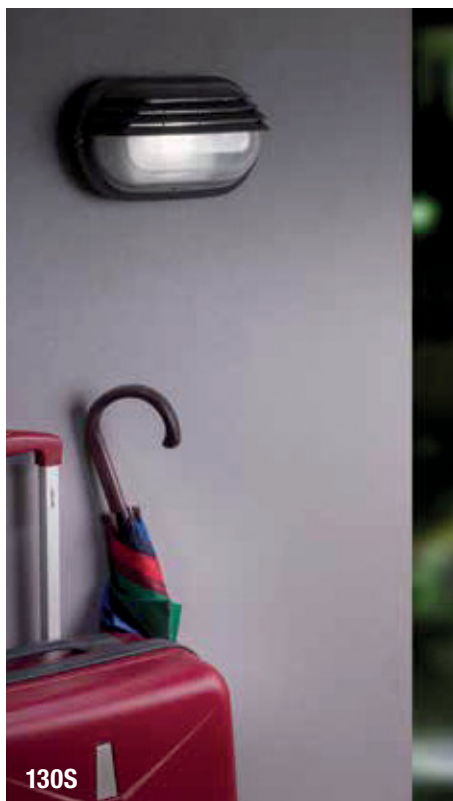

Article		Code		Col.	(mm)	W	Source
	<b>100S</b> <b>IP65</b> <b>IK08</b>		100S/TBIA	S	White	210x120x115	<b>E27</b> HALO - LED
			100S/TNER	S	Black		
	<b>130S</b> <b>IP65</b> <b>IK08</b>		130S/TBIA	S	White	275x155x115	<b>E27</b> HALO - LED
			130S/TNER	S	Black		
	<b>70S</b> <b>IP65</b> <b>IK08</b>		70SA/TBIA	S	White	210x120x100	<b>E27</b> HALO - LED
				70SA/TNER	S	Black	210x120x100

Outdoor

# Termoplastico + Policarbonato - *Thermoplastic + Polycarbonate*



Taormina



Taormina Round - LED Taormina Round

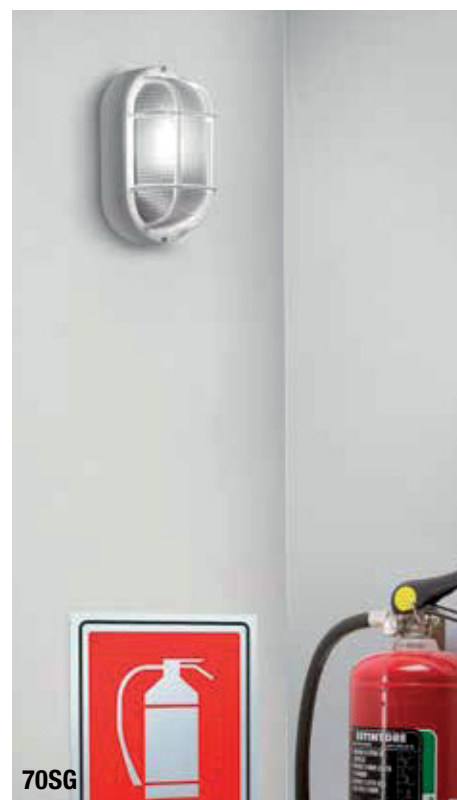









70SG

Outdoor

Article		Code	Col.	(mm)	W	Source	
	<b>Taormina</b> <b>IP65</b> <b>IK08</b>		T/E1031/B	S	White	100x190x95	E27
			T/E1031/N	S	Black		
			T/E1031/G	S	Grey		
	<b>Taormina Round</b> <b>IP65</b> <b>IK08</b>		T/E1033/B	S	White	∅ 191x105	E27 HALO - LED
			T/E1033/N	S	Black		
			T/E1033/G	S	Grey		
	<b>70SG</b> <b>IP65</b> <b>IK08</b>		70SG/TBIA	S	White	120x210x110	E27 HALO - LED
			70SG/TNER	S	Black		

# Termoplastico + Policarbonato - *Thermoplastic + Polycarbonate*



Article			Code		Col.	(mm)	Source
	Round grande IP65 IK08		T/E2060/B	S	White	Ø 280x128	E27
			T/E2060/N	S	Black		
	Tekno basic IP65 IK08		T/E1039/B	S	White	170x230x125	E27
	Tekno 2000 media IP65 IK08		T/E2150/B	S	White	130x205x112	E27
			T/E2150/N	S	Black		
	Tekno 2000 grande IP65 IK08		T/E2160/B	S	White	170x260x125	E27
			T/E2160/N	S	Black		

Outdoor

# Termoplastico + Policarbonato - *Thermoplastic + Polycarbonate*



150



Top con palpebra

Outdoor

Article			Code	Col.	(mm)	Source	
	<b>150</b> <b>IP65</b> <b>IK08</b>		150/TBIA	S	White	160x270x110	E27
			150/TNER	S	Black		
	<b>Top con palpebra</b> <b>IP65</b> <b>IK08</b>		T/E1046/B	S	White	Ø 215x130	E27
			T/E1046/N	S	Black		

## Dati tecnici per applicazione tramite canalina esterna - *Technical data for application via external conduit*

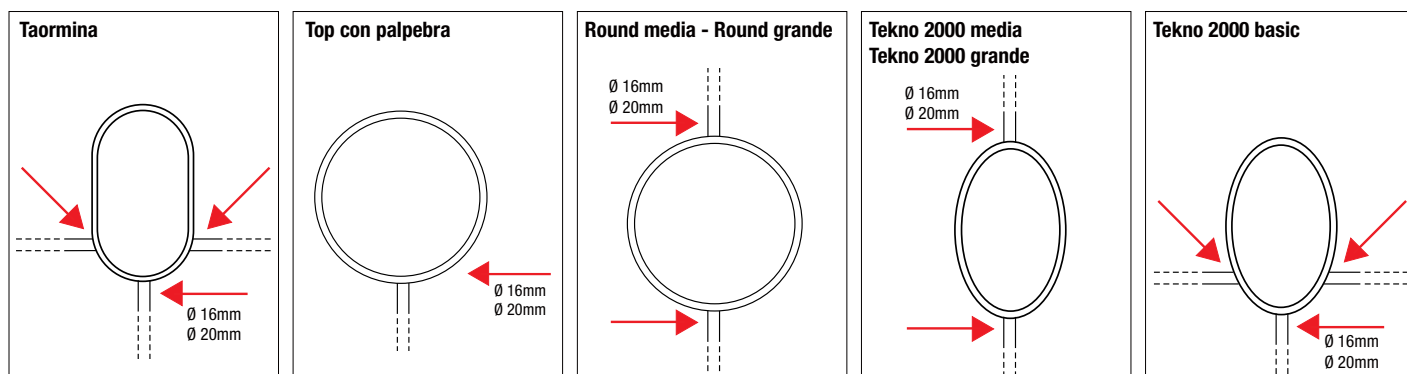

# Termoplastico + Policarbonato - Thermoplastic + Polycarbonate

## PLATAX E27

Plafoniera compatta stagna idonea per applicazioni civili, commerciali, alberghiere ed ovunque siano richieste caratteristiche di protezione contro l'ingresso di polveri o liquidi.

**Corpo e cornice:** in nylon rinforzato con fibre di vetro, guarnizione in silicone, vite-ria imperdibile.

**Riflettore:** in alluminio stampato.

**Diffusore:** in policarbonato opale antiurto ed autoestinguente.

**Cablaggio:** alimentazione 220/240V 50/60Hz, cavo non infiammabile HT105°, morsetteria in nylon.

Platax è installabile sia per impianto sotto parete che esterno; l'ingresso cavo è predisposto per un serracavo di diametro 16 mm. Confezione: termo-retraibile.

*Compact waterproof fitting suitable for public areas, halls, hotels, passages etc. where dust and water protection is necessary.*

**Casing and frame:** nylon reinforced fibreglass, silicon gasket, non-loosening screws.

**Reflector:** Pressed alu-minium. **Diffuser:** Self-extinguishing opal shockproof polycarbonate.

**Wiring:** 220/240V 50/60Hz power supply, HT105° non-flammable cable, nylon connector block.

The cable entry is predisposed for a 16 mm cable gland.

Packaging: termoretraibile film.



220-240V 50/60Hz 750° **IK09** **IP65**

### Platax E27



colour	Lampholder	V	pcs	Kg	S
<b>B</b>	E27	220-240	006	0,850	702198.0101
<b>N</b>	E27	220-240	006	0,850	702206.0101
<b>B</b>	2xE27	220-240	006	0,850	702199.0101

### Accessori - Accessories



**B** Cod. CO3001.100 - Ø 290mm - Visiera Nylon - Nylon visor  
**N** Cod. CO3002.100 - Ø 290mm - Visiera Nylon - Nylon visor

### Lampada non inclusa - Not included lamp



W	V			K		lm	Ra	DIM			H mm	Ø mm	Code
8~(60)	220-240	E27	360°	3000	A	800	80	SI	15.000	25.000	105	60	555286.0101
8~(60)	220-240	E27	360°	4000	A	800	80	NO	15.000	25.000	105	60	555286.4K
10~(100)	220-240	E27	360°	3000	A+	1000	80	SI	15.000	25.000	105	60	555383.0101
10~(100)	220-240	E27	360°	4000	A+	1000	80	NO	15.000	25.000	105	60	555383.4K

# LED Londra - LED Miami

**Installazione:** dotato di molle in acciaio per un rapido e facile inserimento (es. controsoffitti, pannelli in legno, piastrelle) oppure con cassaforma (accessorio), da murare.

**Corpo e ghiera:** alluminio cromato, o Bianco (RAL9010).  
Resistente alla corrosione e agli agenti atmosferici.

**Diffusore:** lente in vetro piano convessa a 60°; riflettore in alluminio anodizzato  
**Guarnizione:** in gomma silicónica.

**Sorgente:** LED **SAMSUNG**. Mantenimento del flusso luminoso al 80%.  
50.000h (L80B20)

**Alimentazione:** non inclusa; dotato di 50cm di cavo FROR PVC 2x0,5mm<sup>2</sup>.

**Installation:** with steel springs for quick and easy insertion (e.g. in false ceilings, wooden panels and tiles) or with casing (accessory) for installation in walls.

**Housing and setting ring:** chromed aluminium or white (RAL9010).  
It is rustproof and resistant to atmospheric agents.

**Shade:** flat-convex glass lens at 60°; reflector in anodized aluminium.  
**Gasket:** in silicone rubber.

**Source:** LED **SAMSUNG**. Maintenance of 80% minimum luminous flux:  
50,000h (L80B20).

**Power supply:** not included with a 50cm of FROR PVC PVC 2x0.5mm<sup>2</sup> wire.



LED Londra								
colour	Max W	mA	Optic	K	lm	pcs	Kg	S + L
B	1	Max 350	60°	3000	120	1	0,02	27343
B	1	Max 350	60°	4000	120	1	0,02	27343-4K
C	1	Max 350	60°	3000	120	1	0,02	27151
C	1	Max 350	60°	4000	120	1	0,02	27151-4K

LED Miami								
colour	Max W	mA	Optic	K	lm	pcs	Kg	S + L
B	1	Max 350	60°	3000	120	1	0,02	27345
B	1	Max 350	60°	4000	120	1	0,02	27345-4K
C	1	Max 350	60°	3000	120	1	0,02	27152
C	1	Max 350	60°	4000	120	1	0,02	27152-4K

A richiesta: disponibile nella versione 2700K e 6000K per ordine di almeno 100 pezzi - *On demand: available in the 2700K and 6000K version on orders of at least 100 pieces of product*

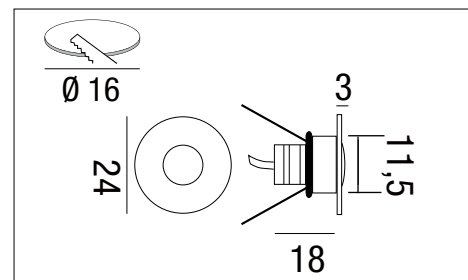
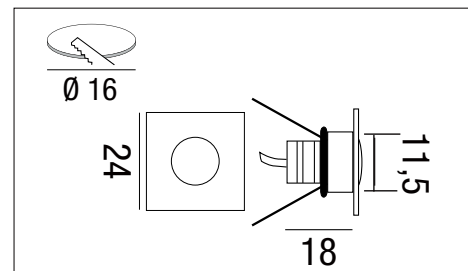
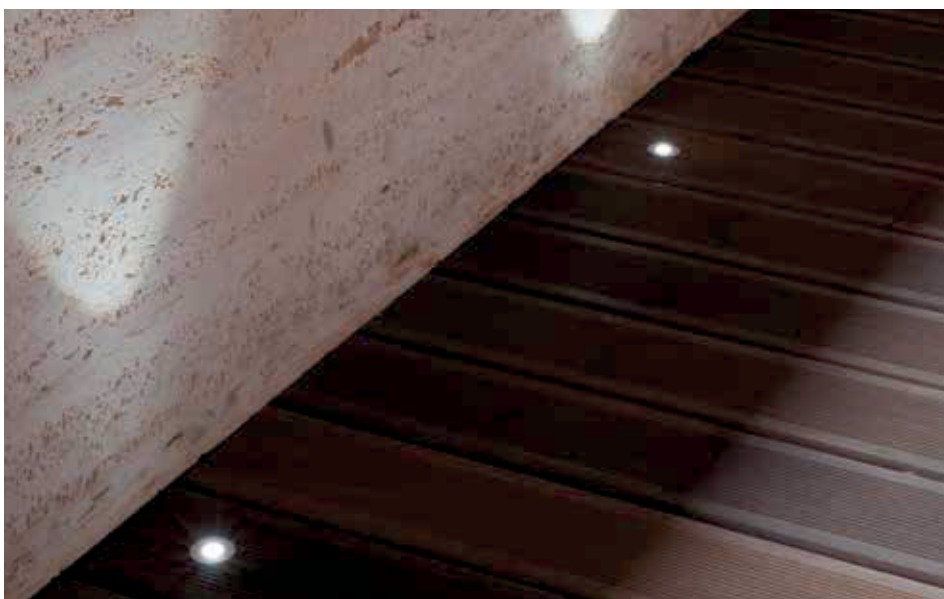

## Accessori NON inclusi - NOT included accessories

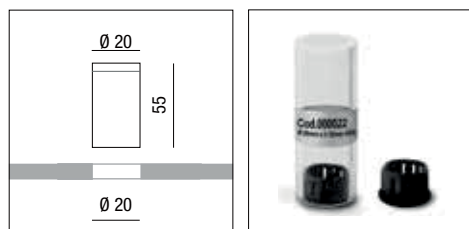

Cod. 000022  
Cassaforma Framework

LED Driver per singola installazione  
LED Driver for single installation  
Dim: 42x40x21mm

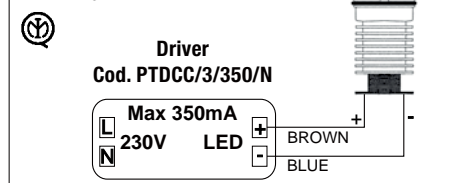

# LED Londra - LED Miami

Installazione in cartongesso con molle (incluse)  
Plasterboard installation with springs (included)

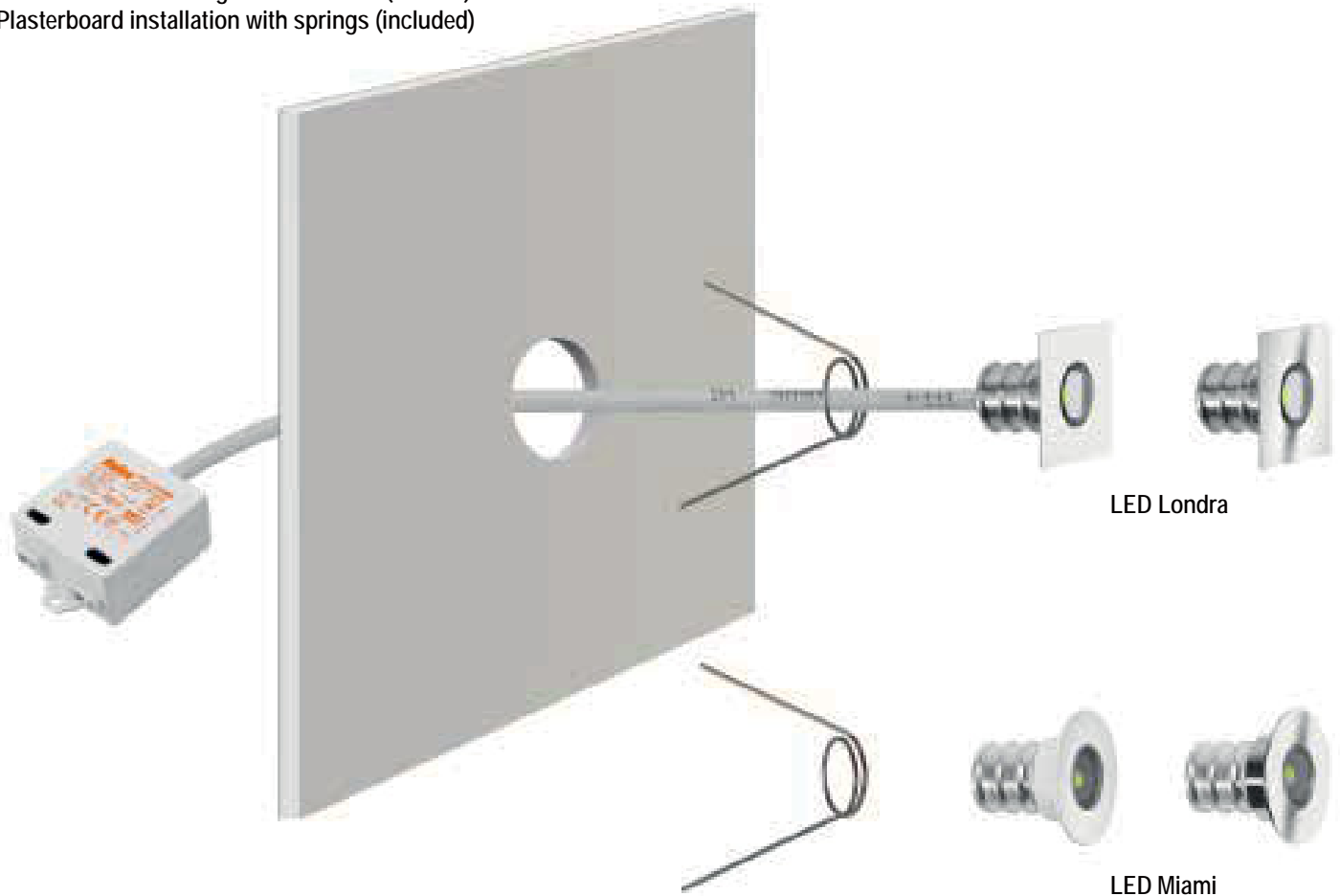

Installazione in piastrelle con cassaforma (NON inclusa)  
Tile installation with formwork (NOT included)

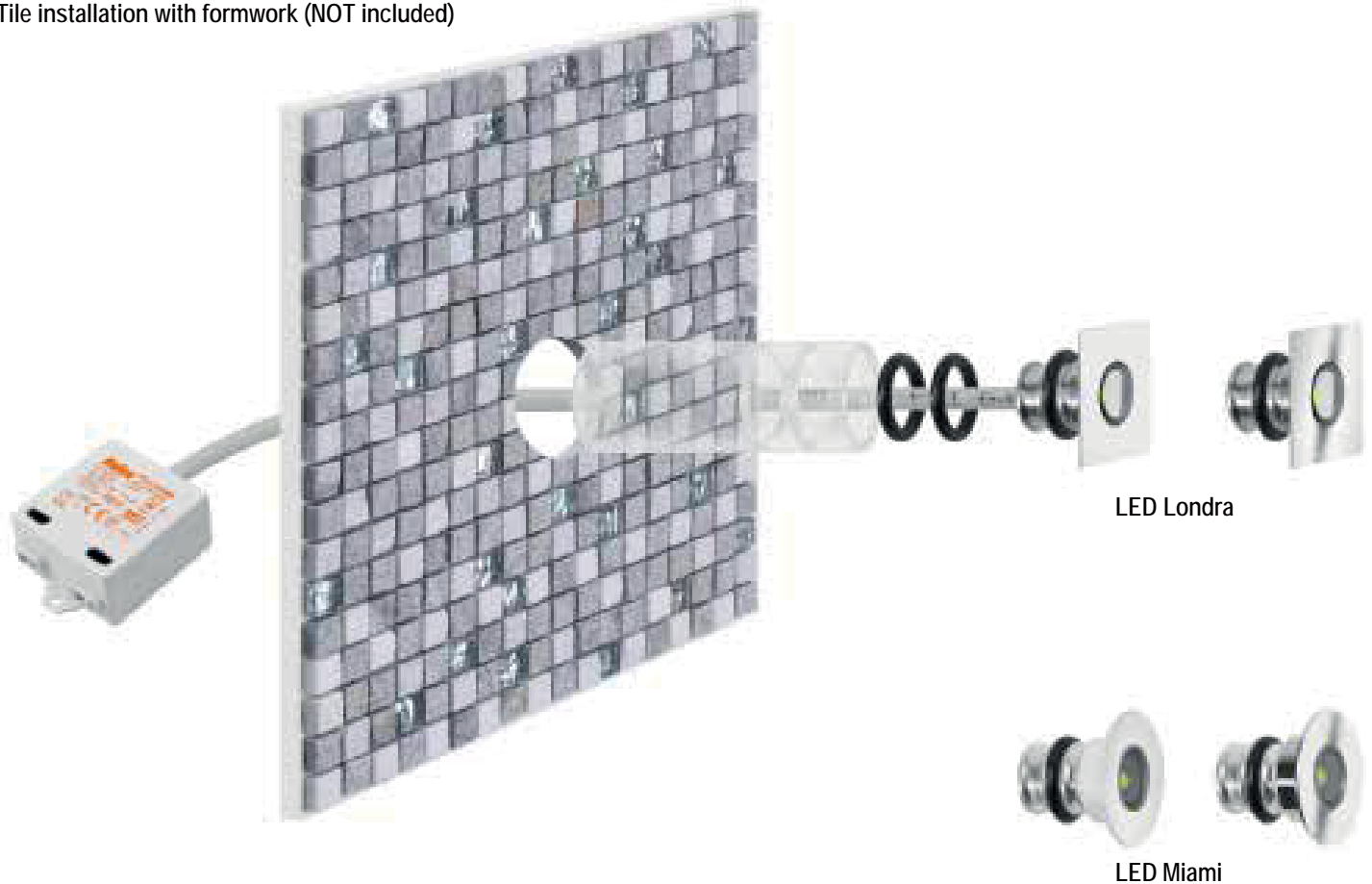

Recessed

# LED Parigi

Apparecchio a LED per utilizzo indoor e outdoor ad incasso, a pavimento/terreno, parete e soffitto. Prodotto non idoneo per l'installazione in piscine e fontane.  
Lo stesso prodotto, se dotato di un accessorio staffa, può essere utilizzato come proiettore architettonico.

**Installazione:** a pavimento con controcassa, a soffitto con alette di fissaggio

**Fascio ottico:** regolabile da 20° a 60° grazie ad un sistema di regolazione manuale retrostante o asimmetrico.

**Corpo e cornice:** in acciaio Inox AISI 304 senza viti a vista

**Diffusore:** in vetro trasparente temprato

**Guarnizione:** in gomma siliconica.

**Carrabilità:** resistenza al carico statico 2.000 Kg tramite controcassa ordinabile separatamente

**Alimentazione:** a bassa tensione di sicurezza in corrente costante (350mA). Da ordinare separatamente.

**Sorgente:** LED **SAMSUNG**

*LED fixture for indoor and outdoor recessed, floor / ground, wall and ceiling use. Product not suitable for installation in swimming pools and fountains.*

*The same product, if equipped with a bracket accessory, can be used as an architectural projector.*

**Installation:** on the floor with outer casing, on the ceiling with fixing tabs

**Optical beam:** adjustable from 20° to 60° thanks to a manual adjustment system behind it or asymmetric.

**Body and frame:** in AISI 304 stainless steel without visible screws

**Diffuser:** in transparent tempered glass

**Gasket:** in silicone rubber.

**Drive over:** resists the static load 2,000 kg through the outer casing, which can be ordered separately

**Power supply:** low voltage safety constant current (350mA). To be ordered separately.

**Source:** LED **SAMSUNG**

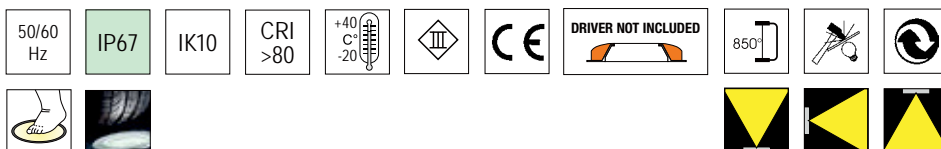

colour	Max W	Max mA	Optic	K	lm output	lm/W	pcs	Kg	S + L
B	2	Max 350	10/60°	3000	280	140	1	0,09	27184N
B	2	Max 350	10/60°	4000	280	140	1	0,09	27184/4KN
S	2	Max 350	10/60°	3000	280	140	1	0,09	27160N
S	2	Max 350	10/60°	4000	280	140	1	0,09	27160/4KN
S	2	Max 350	10/60°	6000	280	140	1	0,09	27188
S	1/2	350/700	60°	FULL COLOR	-	-	1	0,09	27176

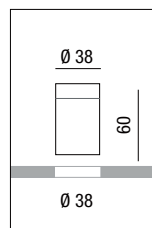
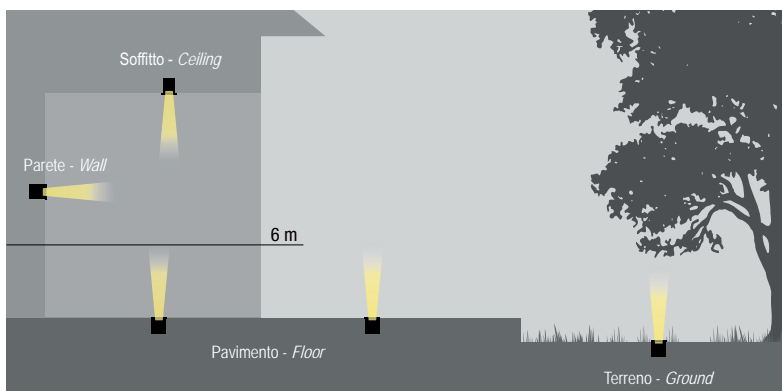
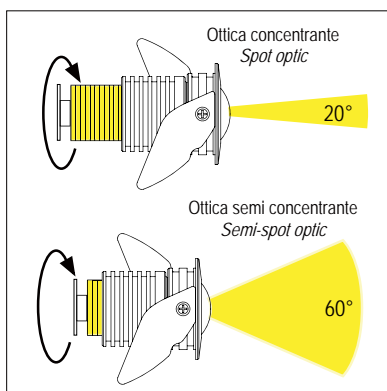
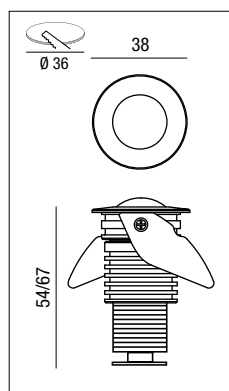

**Cod. 27243**  
Cassaforma per installazioni su muratura.  
Formwork for walling installations.

## LED Parigi, accessori NON inclusi - *NOT INCLUDED* accessory LED Parigi wall



**Cod. 27176 /KIT**  
**Staffa a parete**  
 Montaggio a parete orientabile  
**Wall bracket**  
 Adjustable wall mounting

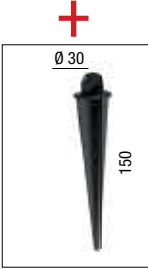

**Cod. 24165**  
 Picchetto in alluminio  
 Aluminum picket



## LED Parigi ASY

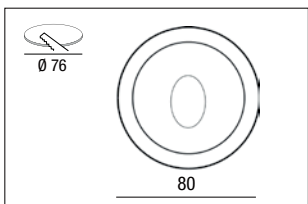
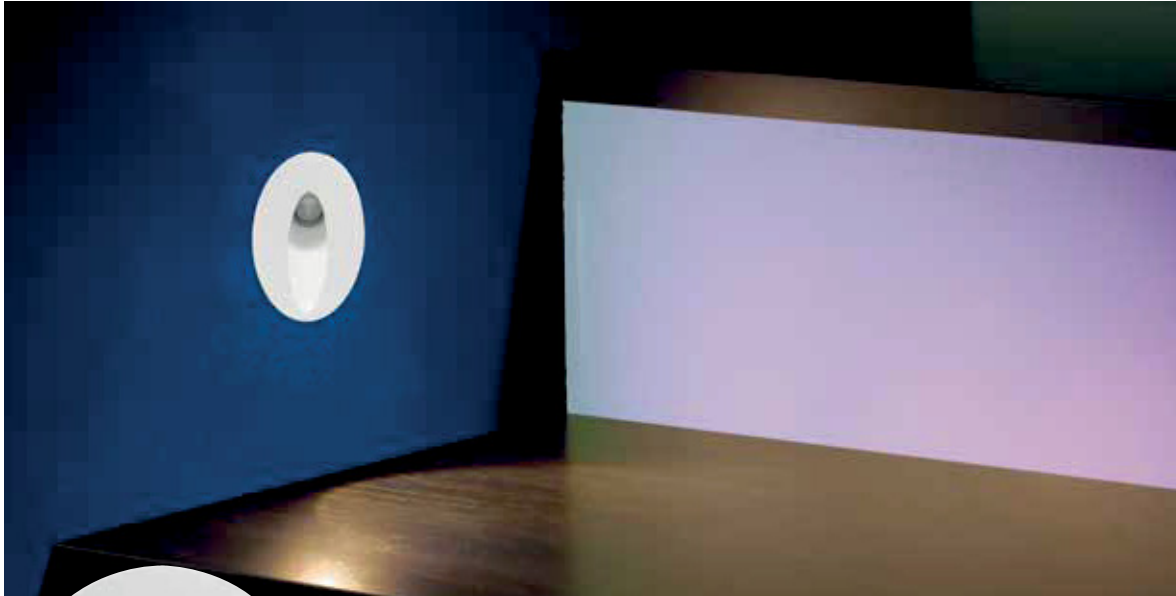

50/60 Hz	IP67	IK10	CRI >80	+40°C / -20°C	III	CE	DRIVER NOT INCLUDED	850°	✂	↻
----------	------	------	---------	---------------	-----	----	---------------------	------	---	---

colour	W	mA	Optic	K	lm output	lm/W	pcs	Kg	S + L
[B]	2	Max 350	ASY	3000	280	140	1	0,09	27184N/ASY
[B]	2	Max 350	ASY	4000	280	140	1	0,09	27184/4KN/ASY

**Cod. PTDC/3/350/N**

Max 350mA  
 230V LED

Recessed

2in1

LED Nasca apparecchio da incasso a pavimento/terra/parete adatto per illuminare percorsi pedonali, aree verdi, porticati ed edifici sia residenziali che pubblici.

**Corpo:** in alluminio pressofuso, struttura in acciaio inox 304.

**Diffusore:** vetro temprato alto 10 mm, garantisce il superamento del test standard IK10.

**Anello:** in gomma silicónica resistente alle alte temperature e impermeabile, alloggiamento di installazione in plastica PP resistente alla corrosione.

**Cassaforma:** in plastica PP resistente alla corrosione.

**Rischio fotobiologico:** nessun rischio fotobiologico, secondo EN 62471:2008.

**Viteria:** in acciaio inossidabile 304.

*LED Nasca floor/ground/wall recessed luminaire suitable for lighting pedestrian paths, green areas, porches and both residential and public buildings.*

*Body: in die-cast aluminum, structure in 304 stainless steel.*

*Diffuser: 10mm high tempered glass, ensure pass IK10 standard test.*

*Ring: high temperature resistant and waterproof silicone rubber, corrosion resistant PP plastic installation housing.*

*Formwork: Corrosion resistant PP plastic.*

*Photobiological risk: no photobiological risk, according to EN 62471:2008.*

*Screws: in 304 stainless steel.*

A richiesta - On demande

1-10Vdc

DALI 2

DYNA

Wireless

Vedi pag. VI - see page VI

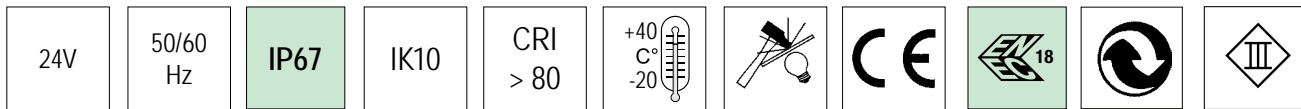

Driver NOT included

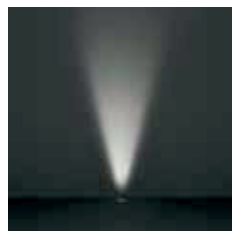

Ottica 30° - Optic 30°



Temperatura inferiore a 40°C - Temperature below 40 ° C



Resistenza al carico statico (5000 Kg) - Resistance to static load (5000 Kg)

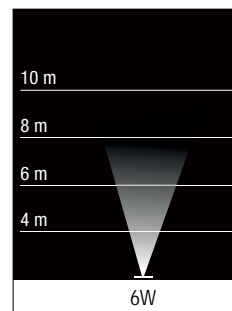

colour	W	angle	K		Max Lumen	Lm/W	pcs	Kg	S + L
<b>S N</b>	6	30°	3000	4000	480	80	1	0,54	RM-032CCT
<b>S N</b>	25	30°	3000	4000	2.000	80	1	0,65	RM-052CCT
<b>S N</b>	40	30°	3000	4000	3.200	80	1	0,75	RM-062CCT

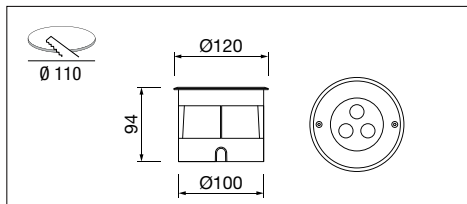

Taratura standard 3000K, per modificare in 4000K seguire il foglio istruzioni  
Standard calibration 3000K, to change to 4000K follow the instruction sheet

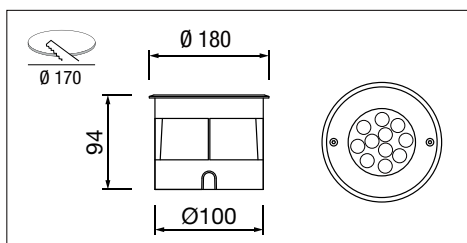

Installazione a terra  
Ground installation



Installazione a pavimento  
Floor installation



Installazione a parete  
Wall installation

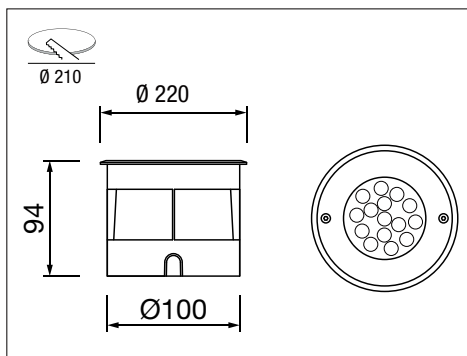

Vetro temperato  
Hardened tempered glass

Telaio in acciaio inox 304  
304 stainless steel frame

Ottica più performante  
Higher performance optic



Custodia di installazione in plastica PP  
PP plastic installation housing

Recessed

Selezioniamo materiali della massima qualità possibile, per garantire una qualità del prodotto di alto livello. Vetro temperato ad alta resistenza con protezione fino a IK10, corpo di installazione in plastica PP, ottiche dal design speciale per mantenere i livelli di prestazioni dell'apparecchio più elevati.

We select materials of highest possible quality, to ensure high-degree product quality. High sturdy tempered glass with protection up to IK10, PP plastic installation housing, special design optics to keep the fixture higher performance levels.

LED Venezia, per l'illuminazione di luoghi come piazze, edifici, sculture e insegne.

- **Corpo e alloggiamento:** in acciaio inossidabile tipo 304.
- **Corpo:** in alluminio puro.
- **Vetro:** temperato trasparente da 15 mm, il carico statico dell'apparecchio può resistere a 5000 kg.
- **Modulo:** il modulo di illuminazione ha un sistema di inclinazione regolabile e ha un'ottica ad alte prestazioni.
- **Installazione:** a scatto.
- L'apparecchio di illuminazione può funzionare in modo continuo di lunghezze standard.
- Resistente all'acqua, è sicuro e affidabile per l'uso.
- La temperatura superficiale massima di tutte le temperature di contatto <50°C per sicurezza e affidabilità.
- Tutte le viti esterne sono realizzate in acciaio inossidabile 304.
- Le caratteristiche tecniche dell'apparecchio sono conformi alle norme EN 60598-1.

*LED Venezia, for landscape lighting places such as square, buildings, sculptures and signs.*

- **Body and housing:** stainless steel type 304 body and installation housing.
- **Body:** Pure aluminium construction fixture body.
- **Glass:** clear tempered glass 15 mm, the static load of the luminaire can resistance 5000kg.
- **Module:** the lighting module has tilt adjustable system, and it has high performance optics.
- **Installation:** snap in installation with no exposed hardware
- The luminaire can continuous run of standard lengths.
- Supplied with oil and water resistant, it is safety and reliable for using.
- The maximum surface temperature of all contact temperature <50°C for safety and reliable.
- All external screw are made of 304 stainless steel.
- The luminaire technical characteristics conform to EN 60598-1 standards.

A richiesta - On demand

1-10Vdc

DALI 2

DYNA

Wireless

Vedi Pag. VI - See page VI

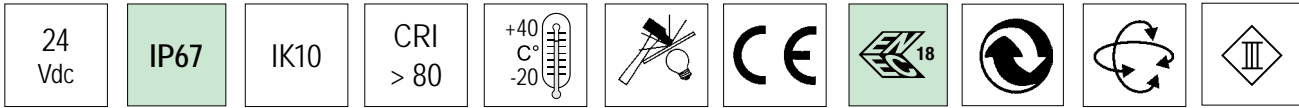

Driver NOT included

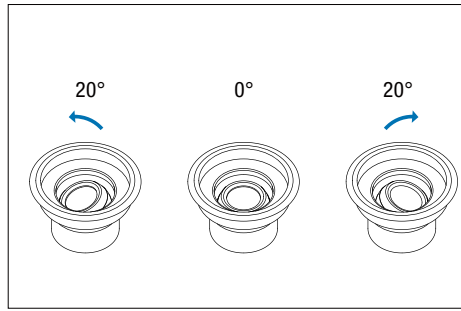
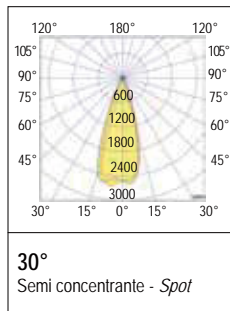

Il prodotto si applica con un design speciale, fornendo la soluzione di illuminazione più efficace per il comfort visivo, evitando abbagliamenti inutili e riducendo l'inquinamento luminoso, la direzione della luce regolabile.

*The product apply with special design, providing the most effective lighting solution for visual comfort, avoiding unnecessary glare and reducing light pollution, the light direction adjustable.*

colour	W	angle	K	Lumen	Lm/W	pcs	Kg	S + L
<b>S N</b>	10	30°	3000	800	80	1	1,80	RL21310-1

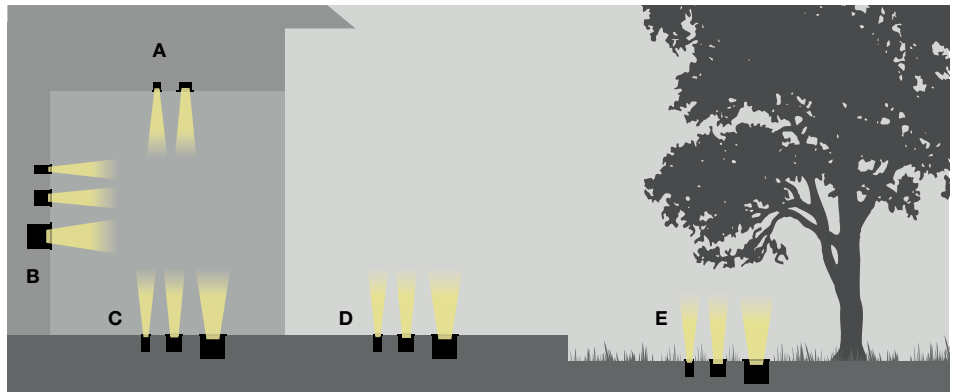
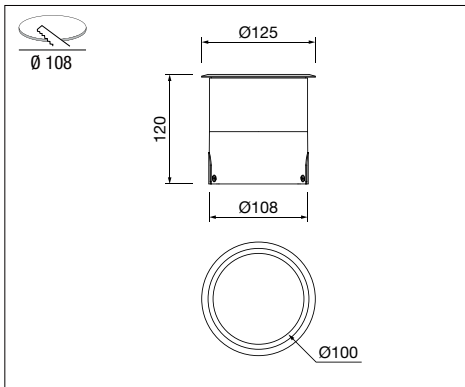

A Soffitto - Ceiling

D Esterno pavimento - Outdoor floor

B Parete - Wall

E Terreno - Ground

C Interno pavimento - Indoor floor

Gli incassi a terra e a pavimento, hanno diversi gradi di resistenza alla torsione e al taglio, fino a 5000 Kg secondo EN 60598-2-13.

*Ground and floor level recessed luminaires, have different degrees of resistance to torsion and shear, up to 5000 Kg in accordance with EN 60598-2-13.*

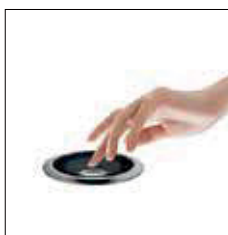

Temperatura inferiore a 40°C  
*Temperature below 40 ° C*



Versione con ottica diffusore completo di vetro antiscivolo  
*Diffuser optics versions complete with non-slip glass*



Resistenza al carico statico (5000 Kg)  
*Resistance to static load (5000 Kg)*

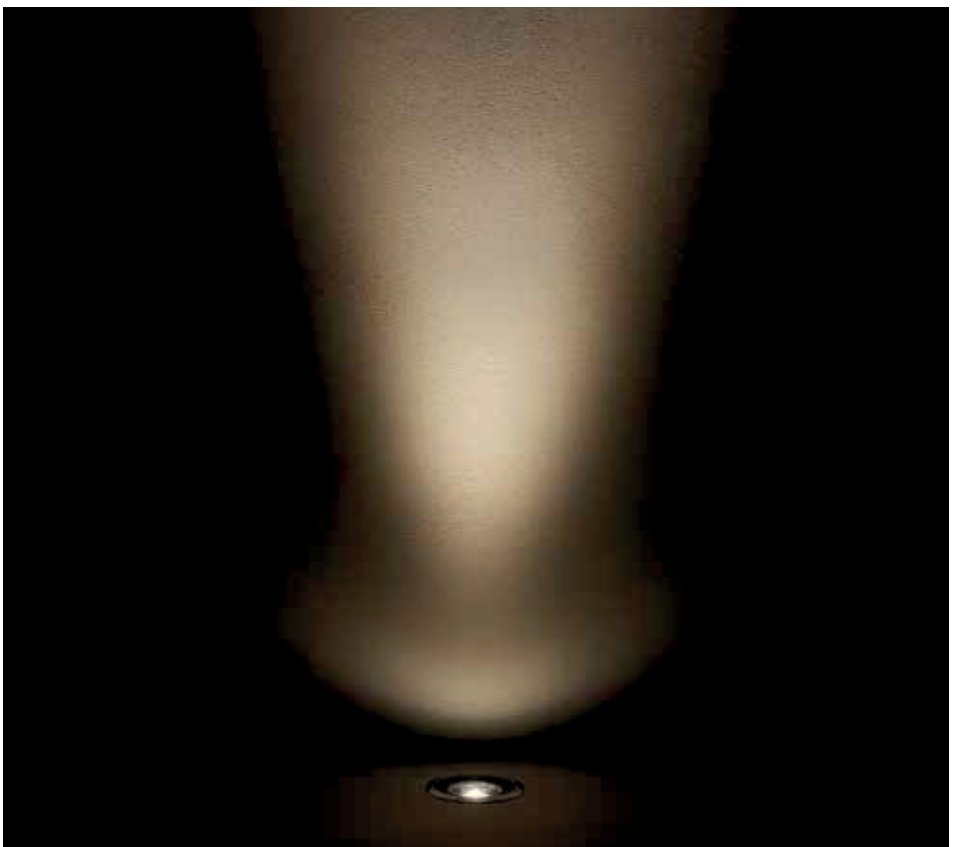

Recessed

# LED Rondò - LED Naasby

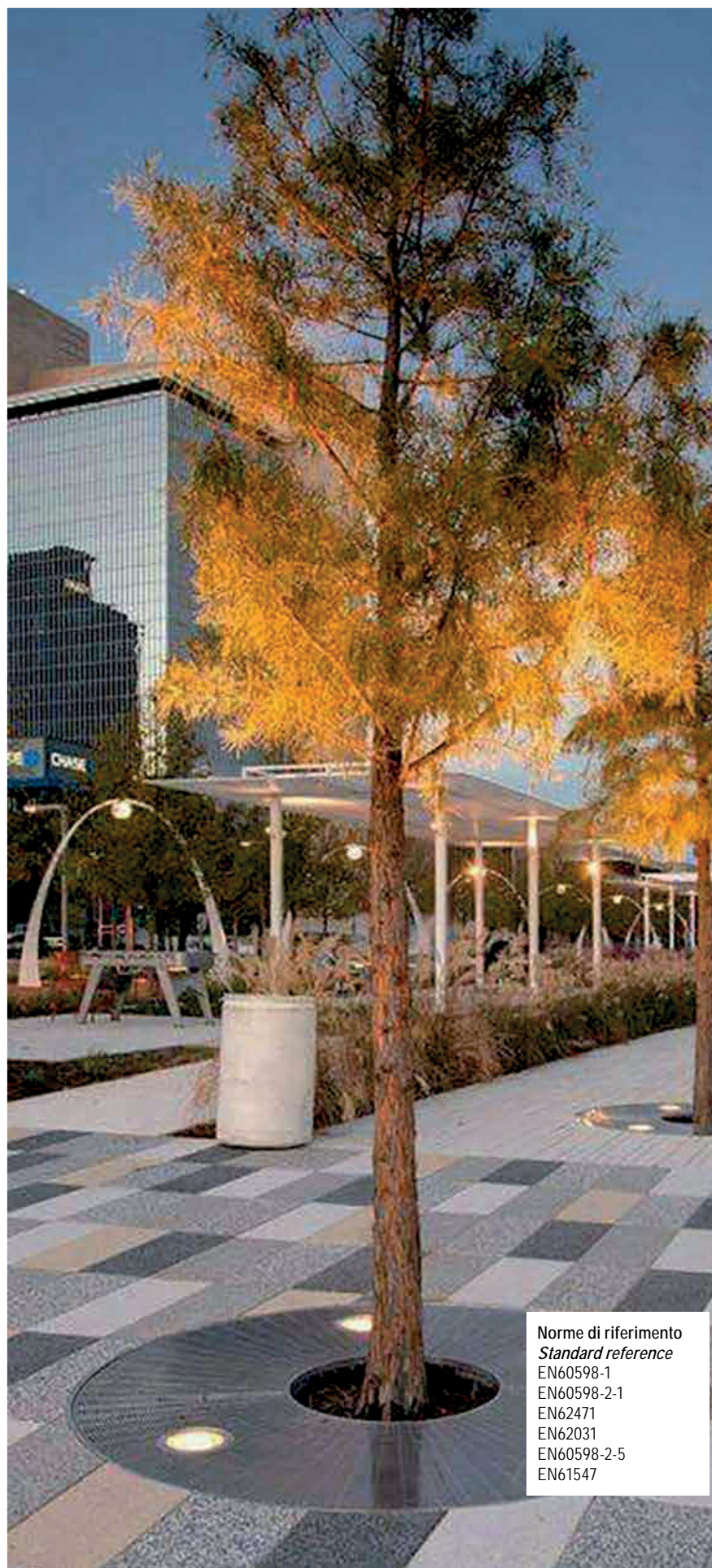

**Norme di riferimento  
Standard reference**  
EN60598-1  
EN60598-2-1  
EN62471  
EN62031  
EN60598-2-5  
EN61547

LED Rondò e LED Naasby sono apparecchi da esterno, ad alto grado di protezione, utilizzabile sia tramite fissaggio che ad incasso ideale per giardini, parchi, aiuole, terrazzi, corselli per piscine.

**Installazione:** incassi a pavimento adatti per illuminare percorsi pedonali, aree verdi, porticati, edifici sia residenziali che pubblici.

**Cassaforma:** inclusa.

**Corpo:** in alluminio pressofuso. Verniciatura di tipo poliesteri eseguita a polvere resistente agli agenti atmosferici e alla nebbia salina. Ghiera e viterie in acciaio Inox AISI 316L.

**Schermo:** vetro temperato 4mm resistente agli shock termici e agli urti (LED Rondò), tecnopolimero (LED Naasby).

**Guarnizioni:** in gomma siliconica.

**Sorgente:** LED **SAMSUNG**

**Driver:** incluso (LED Rondò) escluso (LED Naasby).

*LED Rondò and LED Naasby are a luminaire for outdoor use, with high protection degree, for fixed or recessed installation, for gardens, parks, flowerbeds, terraces, Pool lanes.*

*Installation: floor recessed luminaires suitable for illuminating pedestrian paths, green areas, porches, buildings either public or domestic.*

*Recessed housing: included.*

*Housing: die-cast aluminium body. Polyester powder coating. Resistance to atmospheric agents and corrosion guaranteed in saline mist. Closing ring and screws in stainless steel AISI 316L.*

*Shield: 4mm tempered glass resistant against thermal shocks and collisions (LED Rondò), technopolymer (LED Naasby).*

*Gaskets: made with silicone rubber.*

**Source:** LED **SAMSUNG**

**Driver:** included (LED Rondò), not included (LED Naasby)

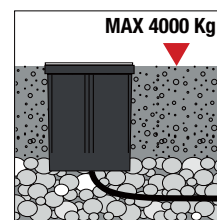

Calpestabile e carrabile, fino a 10Km/h - 1000 Kg con pneumatici gonfiati ad aria. Non sostare.

*Walkable and suitable for vehicles, up to 10Km/h - 1000Kg with tyres inflated with compressed air. Do not stand.*

In caso di posa in muratura, la struttura muraria deve sostenere un carico di 4000 Kg. senza deformarsi. Il fondo della cassaforma è aperto, si rende necessario un fondo di ghiaia per il drenaggio.

*In the event of masonry laying, the wall structure must withstand a load of 4000 Kg. without deforming. The bottom of the framework is open, it's necessary a gravel bottom for drainage.*

# LED Rondò - LED Naasby



Recessed

# LED Rondò

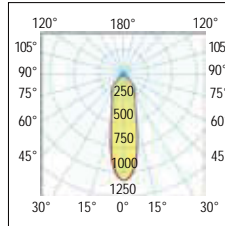

25°  
Semi concentrante - Spot

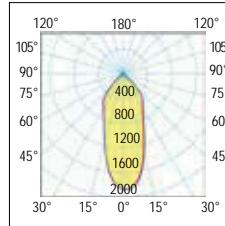

A richiesta - On demand  
40°  
Intermedio - Medium

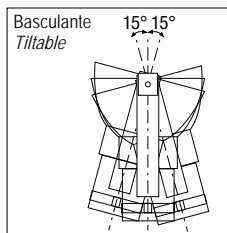
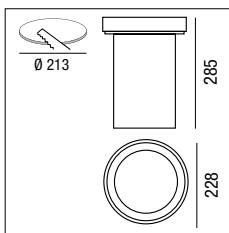
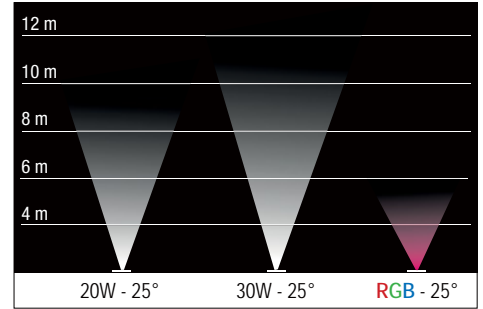

220-240 Vac	110 Vac a richiesta on demand	50/60 Hz	IP67	IK10	CRI >80	+40°C -20°C	CE	DRIVER INCLUDED RIPPLE FREE
850°	RG0	LOW FLICKER						

colour	Max W	angle	K	nominal lm tc = 25°C	lm output	lm/W	pcs	Kg	CELL
C	20	25°	4000	2.600	2.300	116	1	3,8	32567
C	20	25°	3000	2.600	2.300	116	1	3,8	32567-3K
C	30	25°	4000	3.900	3.480	116	1	3,8	32541
C	30	25°	3000	3.900	3.480	116	1	3,8	32540

A richiesta: per quantità disponibile con apertura di fascio a 40° - On demand: for quantity, available with 40° beam angle  
A richiesta: per quantità minima 100 pezzi disponibili a 2700K - On demand: for quantity min 100 pcs available 2700K

Recessed

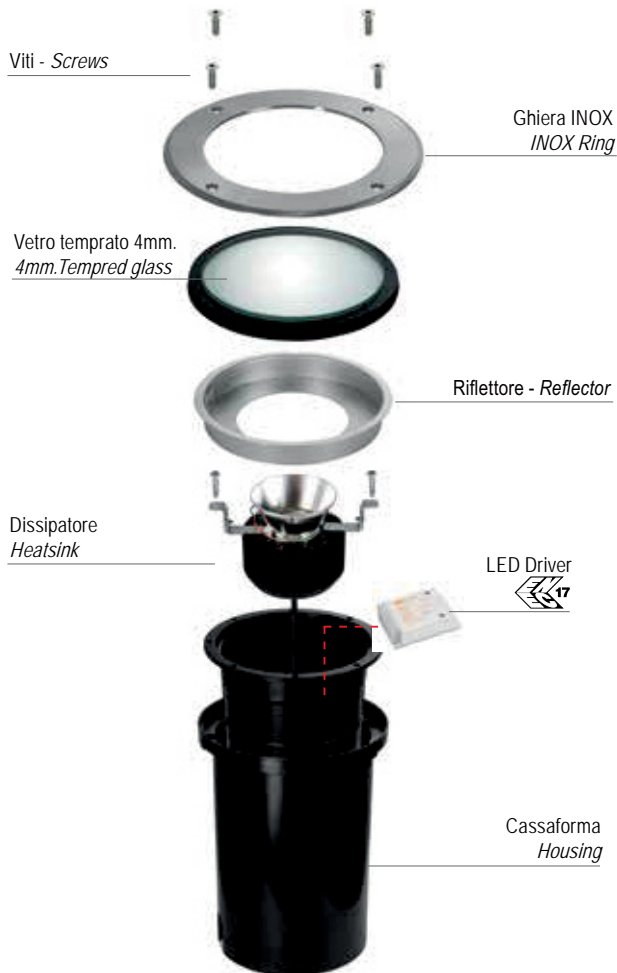

# LED Naasby R

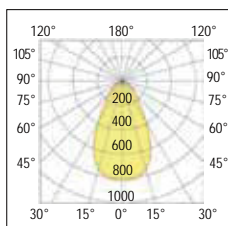

**360°**  
Diffondente - *Diffusing*

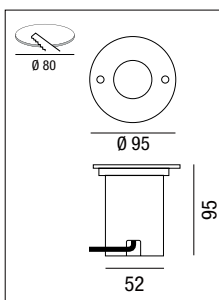

Cassaforma inclusa  
*Included recessed housing*

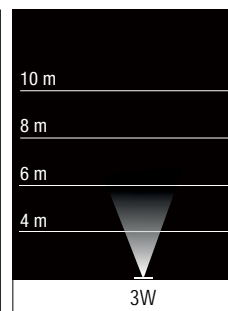

50/60 Hz IP67 IK09 CRI >80 +40°C / -20°C III CE DRIVER NOT INCLUDED 850°

colour	Max W	mA	angle*	K	nominal lm - tc = 25°C	lm output	lm/W	pcs	Kg	S+L
C	3	350	360°	4000	426	370	125	1	0,55	90.039/4K
C	3	350	360°	3000	426	370	125	1	0,55	90.039

\* Fascio luminoso a luce diffusa - *Diffused light beam*

# LED Naasby Q

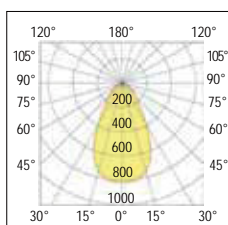

**360°**  
Diffondente - *Diffusing*

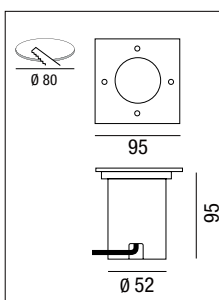

Cassaforma inclusa  
*Included recessed housing*

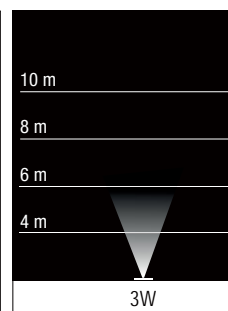

50/60 Hz IP67 IK09 CRI >80 +40°C / -20°C III CE DRIVER NOT INCLUDED 850°

colour	Max W	mA	angle*	K	nominal lm - tc = 25°C	lm output	lm/W	pcs	Kg	S+L
C	3	350	360°	4000	426	370	125	1	0,55	90.034/4K
C	3	350	360°	3000	426	370	125	1	0,55	90.034

\* Fascio luminoso a luce diffusa - *Diffused light beam*

## Esempi applicativi - application examples

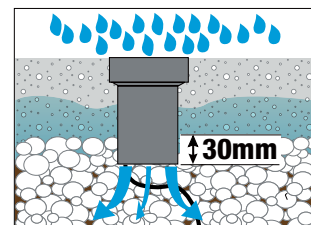
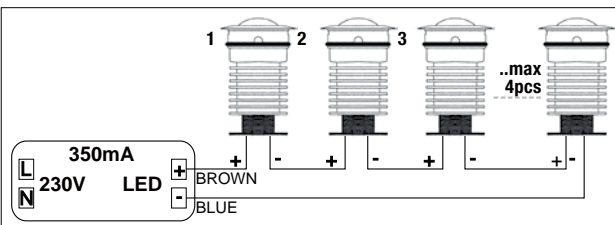
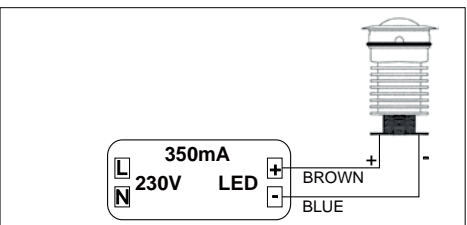

**Dimensioni/Dimension**

**Cod. PTDC/3/350/N**  
**3W**

LED Driver per singola installazione  
*LED Driver for single installation*

**Dimensioni/Dimension**

**Cod. RN9150-2**  
**Max 15W**

LED Driver per collegamento in serie  
*LED Drivers for series connection*

Al fine di permettere un adeguato drenaggio si consiglia di preparare un fondo di ghiaia in fase di installazione. Per il collegamento è necessario l'utilizzo di nastro agglomerante, tipo PE.

*We advise you to prepare a gravel drain fund for installing the products, to ensure suitable drainage. The PE type agglomerating tape is required for the connection.*

Recessed

LED Firenze, per l'illuminazione di luoghi come piazze, edifici, sculture e insegne.

- **Corpo:** in acciaio inossidabile tipo 304, custodia di installazione in ABS / acciaio inossidabile tipo 304.
- **Vetro:** temperato trasparente da 15 mm. Il carico statico dell'apparecchio può resistere a 5000 kg.
- **Ottica:** buon design, speciale per ottica ad alte prestazioni, e sistema antiriflesso.
- **Installazione:** a scatto senza.
- Resistente all'acqua, è sicuro e affidabile per l'uso.
- La temperatura superficiale massima di tutte le temperature di contatto <50°C per sicurezza e affidabilità.
- Tutte le viti esterne sono realizzate in acciaio inossidabile 304.

*LED Firenze, for landscape lighting places such as square, buildings, sculptures and signs.*

- **Body:** stainless steel type 304 body, ABS stainless steel type 304 installation housing.
- **Glass:** clear tempered glass 15 mm, the static load of the luminaire can resistance 5000kg.
- **Optic:** special good design for high performance optics and anti glare system.
- **Installation:** snap in installation with no exposed hardware
- Supplied with oil and water resistant, it is safety and reliable for using.
- The maximum surface temperature of all contact temperature <50°C for safety and reliable.
- All external screw are made of 304 stainless steel.
- The luminaire technical characteristics conform to EN 60598-1 standards.

A richiesta - On demand

1-10Vdc

DALI 2

DYNA

Wireless

Vedi Pag. VI - See page VI

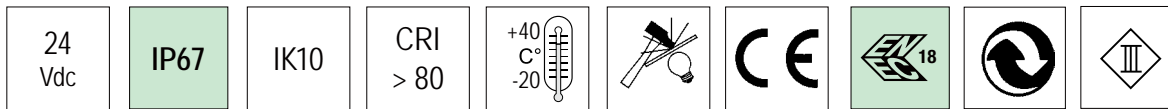

**Driver NOT included**

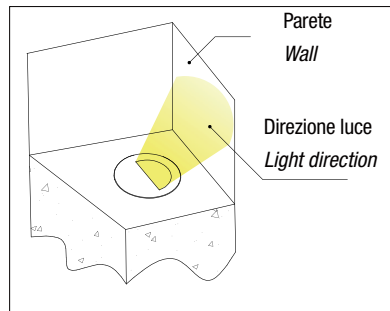
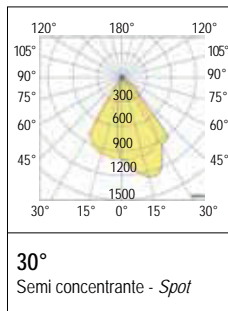
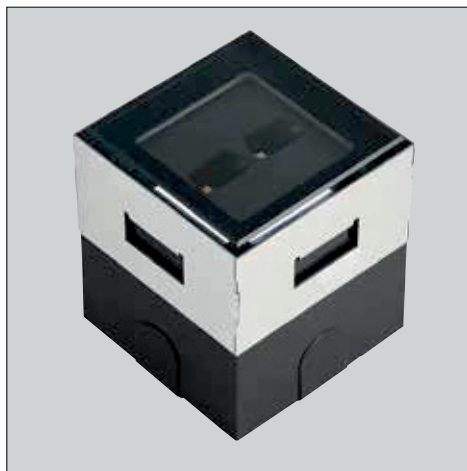

Il prodotto si applica con un design speciale, fornendo la soluzione di illuminazione più efficace per il comfort visivo, evitando abbagliamenti inutili e riducendo l'inquinamento luminoso.

*The product apply with special design, providing the most effective lighting solution for visual comfort, avoiding unnecessary glare and reducing light pollution.*

colour	W	angle	K	Lumen	Lm/W	pcs	Kg	S + L
<b>S N</b>	6	ASY	3000	500	83	1	1,50	RL2146-2

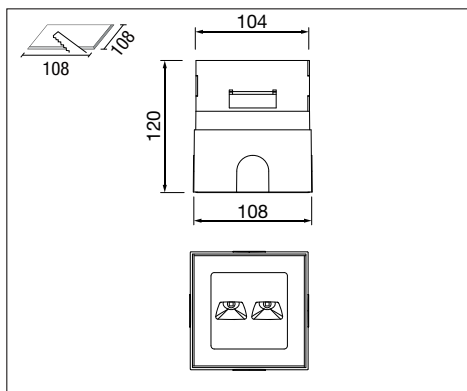

Selezioniamo materiali della massima qualità possibile, per garantire una qualità del prodotto di alto livello. Vetro temperato ad alta robustezza con protezione fino a IK10, corpo di installazione in acciaio inox 304, riflettore dal design speciale per mantenere l'apparecchio a livelli prestazionali più elevati.

*We select materials of highest possible quality, to ensure high-degree product quality. High sturdy tempered glass with protection up to IK10, 304 stainless steel installation housing, special design reflector to keep the fixture higher performance levels.*

Gli incassi a terra ea terra, hanno diversi gradi di resistenza alla torsione e al taglio, fino a 5000 Kg secondo EN 60598-2-13.

*Ground and floor level recessed luminaires, have different degrees of resistance to torsion and shear, up to 5000 Kg in accordance with EN 60598-2-13.*



Temperatura inferiore a 40°C  
*Temperature below 40 ° C*



Versione con ottica diffusore completo di vetro antiscivolo  
*Diffuser optics versions complete with non-slip glass*



Resistenza al carico statico (5000 Kg)  
*Resistance to static load (5000 Kg)*



Installato a filo pavimento  
*Installed flush with floor*



Recessed

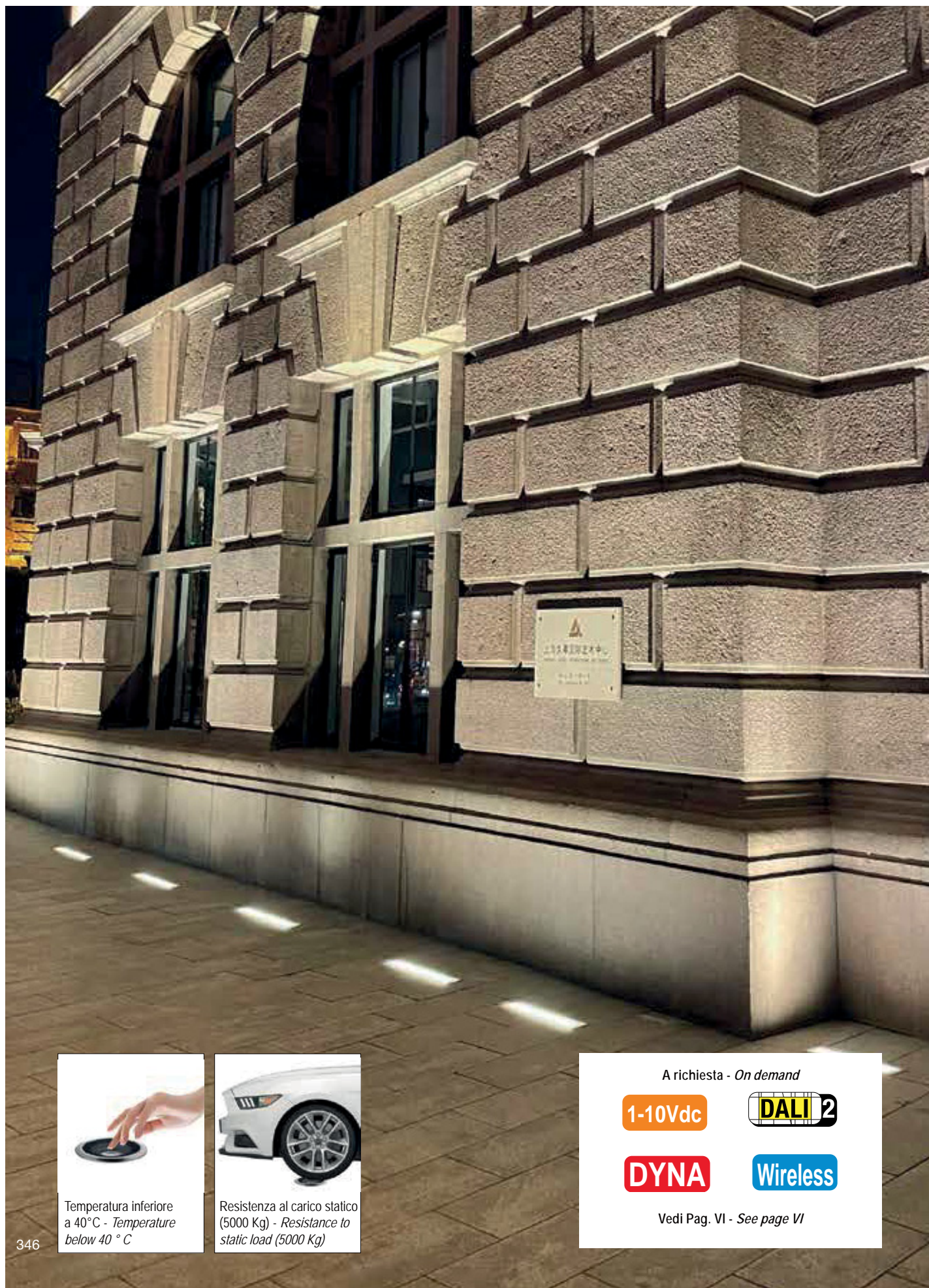

Temperatura inferiore a 40°C - Temperature below 40 °C



Resistenza al carico statico (5000 Kg) - Resistance to static load (5000 Kg)

A richiesta - On demand

1-10Vdc

DALI 2

DYNA

Wireless

Vedi Pag. VI - See page VI

# LED Monocilindrico

Apparecchio a LED da incasso per aree urbane e residenziali. Adatto per illuminare edifici, monumenti e strade.

**Installazione:** a pavimento con cassaforma

**Corpo e cornice:** estruso in alluminio anodizzato minimo 20 micron

**Cornice esterna:** cornice esterna 316 L cromo satinato

**Diffusore:** in vetro trasparente temprato

**Guarnizione:** in gomma siliconica.

**Carrabilità:** calpestabile e carrabile, fino a 10Km/h - 1000 Kg con pneumatici gonfiati ad aria. Non sostare.

**Alimentazione:** Da ordinare separatamente.

Copertura laterale iniezione in alluminio

*Recessed LED luminaire for urban and residential areas. Suitable for illuminating buildings, monuments and streets.*

*Installation: on the floor with formwork*

*Body and frame: extruded anodized aluminum at least 20 micron*

*External frame: external frame 316 L satin chrome*

*Diffuser: in tempered transparent glass*

*Gasket: silicone rubber.*

*Drive-over: walkable and drive-over, up to 10Km / h - 1000kg with air-inflated tires. Don't stop.*

*Power supply: To be ordered separately.*

*Aluminum injection side cover*

24  
Vdc

IP67

IK10

CRI  
> 85

+45  
C°  
-30

Driver **NOT** included



colour	W	angle	K	nominal Im tc = 25°C	Im output	Im/W	pcs	Kg	S + L
<span style="border: 1px solid black; padding: 1px;">C</span>	24	25°	4000	2.600	2.225	92	1	4,00	RL218NWM01
<span style="border: 1px solid black; padding: 1px;">C</span>	24	25°	3000	2.600	2.225	92	1	4,00	RL218WWM01
<span style="border: 1px solid black; padding: 1px;">C</span>	48	25°	4000	5.000	4.320	90	1	7,30	RL436NWM01
<span style="border: 1px solid black; padding: 1px;">C</span>	48	25°	3000	5.000	4.320	90	1	7,30	RL436WWM01

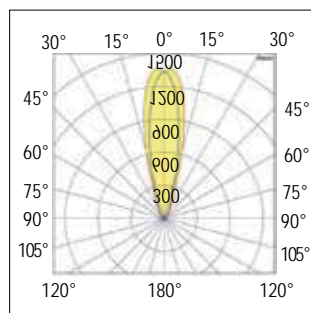
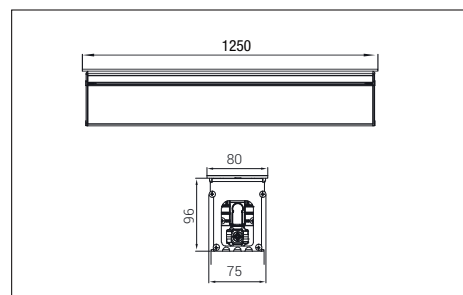
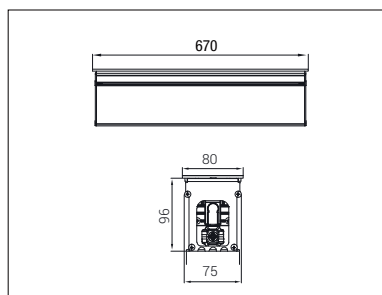

H (mt)	Ø (m)	E <sub>max</sub> (lx)
3.0	3,59	102
1.5	2,99	147
2.0	2,39	230
1.5	1,8	408
1.0	1,20	919
0.5	0,60	3674

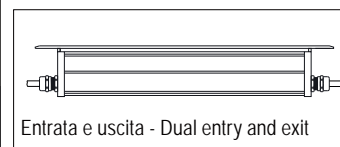
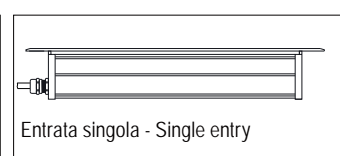
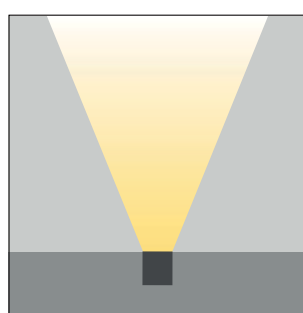

## A richiesta - On demand

Angolo extra stretto  
Extra narrow angle

Angolo ampio  
Wide angle

Senza lente  
Without lens

Asimmetrico  
Asymmetrical

Ellittico stretto  
Elliptical narrow

Ellittico medio  
Elliptical medium

Recessed

Apparecchio da incasso a pavimento/terra/parete previsto per le applicazioni secondo necessità. Luce laterale radiale ad emissione unilaterale e bidirezionale, con elevato comfort visivo e buon effetto antiriflesso.

**Corpo:** in alluminio pressofuso. Nero RAL 9005

**Diffusore** in pc di alta qualità.

**Anello:** in gomma siliconica resistente alle alte temperature e impermeabile

**Cassaforma:** in plastica PP resistente alla corrosione.

**Rischio fotobiologico:** nessun rischio fotobiologico, secondo EN 62471:2008.

**Viteria:** in acciaio inossidabile 304.

*Floor/ground/wall-mounted recessed luminaire intended applications as required.*

*Side radial light with unilateral & bidirectional emission, it with high visual comfort and good anti glare effect.*

**Body:** die-casting aluminium body. RAL 9005 Black

**Diffuser:** high quality pc diffuser.

**Rubber ring:** high temperature resistant and waterproof silicone rubber ring

**Housing:** corrosion resistant PP plastic installation housing.

**Photo-biological risk:** no photo-biological risk, in accordance with EN 62471:2008.

**Screws:** all external screw are made of 304 stainless steel.

A richiesta - On demand

1-10Vdc

DALI 2

DYNA

Wireless

Vedi Pag. VI - See page VI

24 Vdc	IP67	IK09	CRI > 80	+40°C -20°C		CE	EN 18		
--------	------	------	----------	----------------	--	----	-------	--	--

**Driver NOT included**

**Doppia luce**  
Double light

**Singola luce**  
Single light

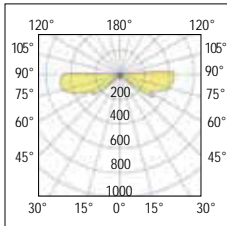

**120°**  
Semi concentrante - Spot



Temperatura inferiore a 40°C - Temperature below 40 °C



Resistenza al carico statico (5000 Kg) - Resistance to static load (5000 Kg)

colour	W	angle	K	Lumen	Lm/W	pcs	Kg	S+L
<b>S N</b>	2	120°	3000	140	70	1	0,54	RLM-01A

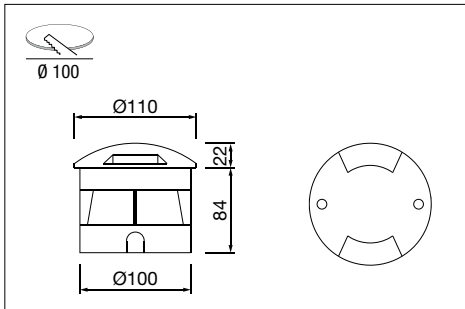

Installazione a terra  
Ground installation



Installazione a pavimento  
Floor installation



Installazione a parete  
Wall installation

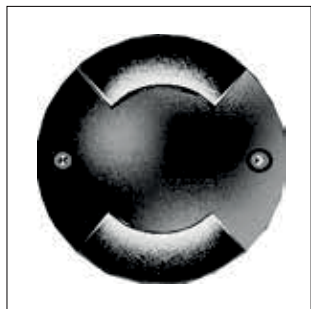
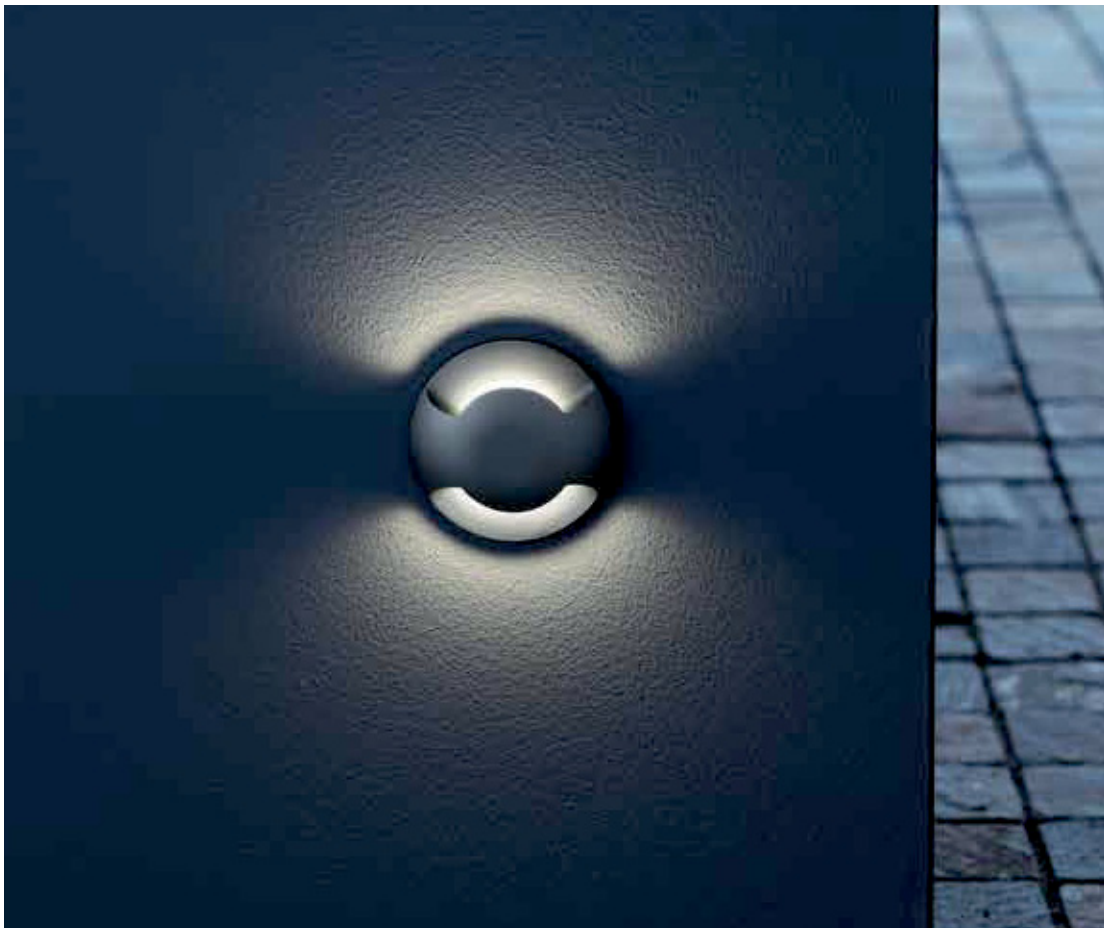

LED Radiante viene fornito con frangiluce doppia emissione  
LED Radiante comes with double emission light diffuser

Accessori NON inclusi  
NOT included accessories



**Cod. M-01B**  
Frangiluce mono emissione  
Mono emission light diffuser

Recessed

Apparecchio da incasso a pavimento/terra/parete previsto per le applicazioni secondo necessità. Luce laterale radiale ad emissione bidirezionale, con elevato comfort visivo e buon effetto antiriflesso.

**Corpo:** in alluminio pressofuso. Nero RAL 9005

**Diffusore:** in pc di alta qualità.

**Anello:** in gomma siliconica resistente alle alte temperature e impermeabile

**Cassaforma:** in acciaio zincato a caldo.

**Rischio fotobiologico:** nessun rischio fotobiologico, secondo EN 62471:2008.

**Viteria:** in acciaio inossidabile 304.

*Floor/ground/wall-mounted recessed luminaire intended applications as required. Side radial light with unilateral & bidirectional emission, it with high visual comfort and good anti glare effect.*

**Body:** die-casting aluminium body. RAL 9005 Black

**Diffuser:** high quality pc diffuser.

**Rubber ring:** high temperature resistant and waterproof silicone rubber ring

**Housing:** in hot galvanized steel.

**Photo-biological risk:** no photo-biological risk, in accordance with EN 62471:2008.

**Screws:** all external screw are made of 304 stainless steel.

A richiesta - On demand

1-10Vdc

DALI 2

DYNA

Wireless

Vedi Pag. VI - See page VI

24 Vdc	IP67	IK09	CRI > 80	+40°C -20°C		CE	EN 18		
--------	------	------	----------	----------------	--	----	-------	--	--

Driver NOT included

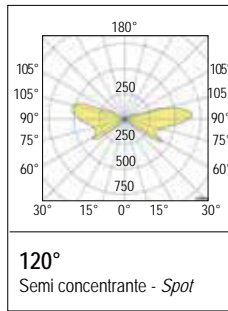

Temperatura inferiore a 40°C - Temperature below 40 °C



Resistenza al carico statico (5000 Kg) - Resistance to static load (5000 Kg)



colour	W	angle	K	Lumen	Lm/W	pcs	Kg	S+L
S	4	120°	3000	280	70	1	0,83	RLM-16A

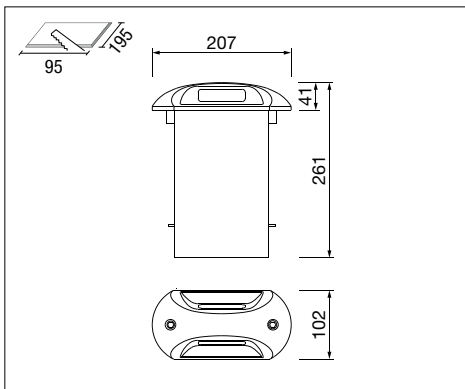

Installazione a terra  
Ground installation



Installazione a pavimento  
Floor installation



Installazione a parete  
Wall installation



Recessed

# Illuminazione RGB - RGB lighting



RGB

Creare suggestive scenografie luminose in grado di valorizzare architetture importanti, ma anche di dare un valore estetico impensabile ad edifici anonimi. A queste possibilità offerte dalle luci colorate oggi si può aggiungere un elemento in più, ovvero quello del dinamismo. Il cambio di colore e di intensità della luce reso possibile dagli apparecchi di illuminazione RGB o RGBW diventa un vero e proprio cambio di scenari spettacolari. Questo tipo di soluzione si applica ai seguenti prodotti

*Creating suggestive luminous scenographies able to enhance important architectures, but also to give an unthinkable aesthetic value to anonymous buildings. To these possibilities offered by colored lights today we can add an extra element, namely that of dynamism. The change of color and intensity of light made possible by RGB or RGBW lighting fixtures becomes a veritable cambio of spectacular scenarios.*

*This type of solution applies to the following products*

LED Lince 68 Wall Washer RGBW

IP68



LED Lince 68 RGBW

IP68



LED Lampo RGBW

LED Monza Round Wall Washer RGBW



LED Rondò RGB

LED Flex RGB



LED Gargano RGB



# LED Monza round Wall Washer RGBW

RGB



Sistema LED lineare per applicazioni professionali nell'illuminazione di facciate, portici, sottopassaggi e in generale per l'illuminazione di particolari elementi architettonici. A richiesta è possibile collegare gli apparecchi in serie per ottenere delle linee di luce continua.

**Installazione:** su superfici verticali e orizzontali (completo di staffa di fissaggio).

**Corpo:** in policarbonato trasparente, resistente agli urti.

**Testate di chiusura:** in PVC, colore nero

**Staffa di fissaggio:** in alluminio, verniciata con polvere termoindurente poliesteri

**Guarnizione:** in gomma ai siliconi dalle rilevanti prestazioni meccaniche ed elastiche

**Dispositivo anticondensa:** valvola di compensazione e riciclo dell'aria

**Norme di riferimento**

EN60598-1; EN60598-2-1; EN62471; EN62031; EN61547

**Sorgente:** LED RGBW

**Colori della luce ottenibili:** tutta la banda cromatica delle radiazioni visibili compreso il **BIANCO**

**Cablaggio:** 1,5m cavo tipo H05RN-F 5x1mm<sup>2</sup> e connettore rapido 5 poli IP66 maschio/femmina per la connessione elettrica

*LED linear system for professional lighting applications on facades, arcades, tunnels and generally to light up particular architectural elements. On demand it is possible to make a serial connection of the luminaires to have continuous light lines.*

**Installation:** on vertical and horizontal surfaces (complete with fixing bracket)

**Housing:** made by transparent polycarbonate, resistant to collisions

**End caps:** made by PVC, black color

**Fixing bracket:** made by aluminum, coated with polyester thermoset powder

**Gasket:** made by silicone rubber with high mechanical and elastic performance

**Anti-condensate device:** valve for compensation and circulation of air

**Standard reference**

EN60598-1; EN60598-2-1; EN62471; EN62031; EN61547

**Light source:** RGBW LEDs

**Achievable light colors:** all the chromatic range of visible radiations WHITE included

**Wiring:** 1,5m cable type H05RN-F 5x1mm<sup>2</sup> and 5-pole IP66 male/female quick connector for the electrical connection

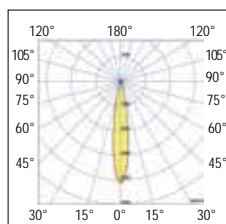

15°  
Concentrante  
Narrow  
Schermo trasparente standard  
Standard transparent shield

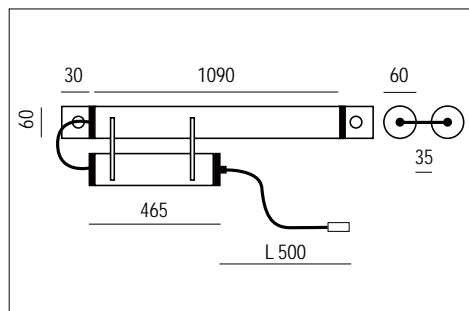
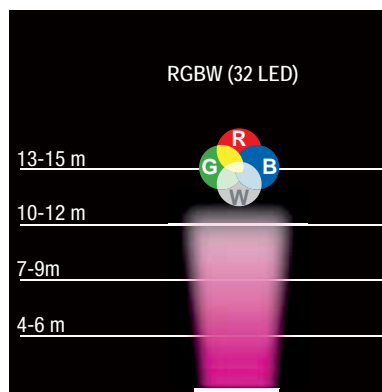

220-240 Vac	50/60 Hz	IP67	IK09	+40 C° -20	850°		
		CE	Driver included				

colour	W	angle	nominal lm tc = 25°C	lm output	pcs	Kg	CELL
T	40	15°	2640	R = 360 - G = 650 - B = 240 W = 740 (6500K)	1	1,20	27393/RGB

Predisposto per cablaggio passante (vedi accessorio opzionale cod. XPG9-P104)  
Set-up for through-wiring (see optional accessory code XPG9-P104).

# LED Monza round Wall Washer RGBW

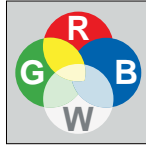

Questa tecnologia consente di ottenere un bianco puro oltre a tutte le gradazioni cromatiche, senza l'influenza dei colori RGB (vedi foto).

This technology makes it possible to achieve pure white in addition to every shade of colour, without the influence of RGB colours.



Cod. KE2  
Controller DMX Driver (Pag. 207)

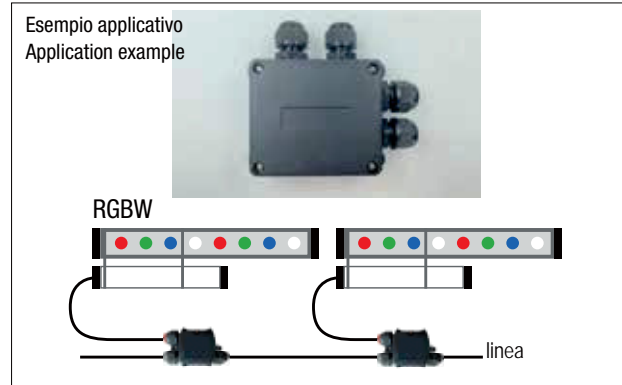

Cod. XPG9-P104  
Accessorio IP67 per linee di luce continua  
IP67 accessory for continuous light lines.



Completo di connettore IP68 per una rapida installazione  
Complete with IP68 connector for quick installation

## Schema di collegamento - Wiring diagram

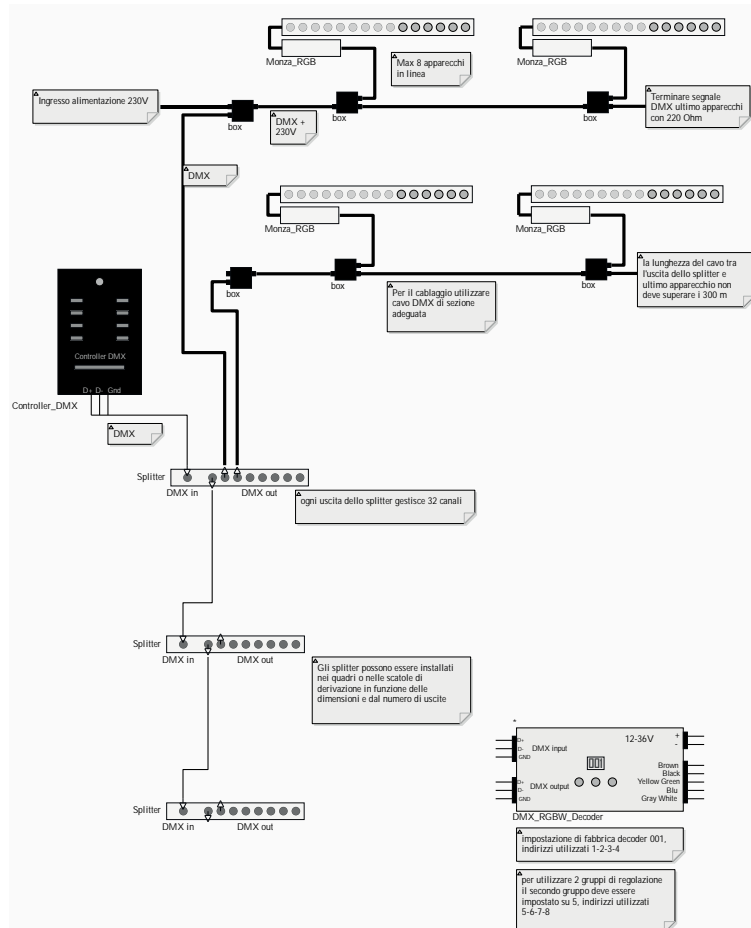

# LED Rondò RGB

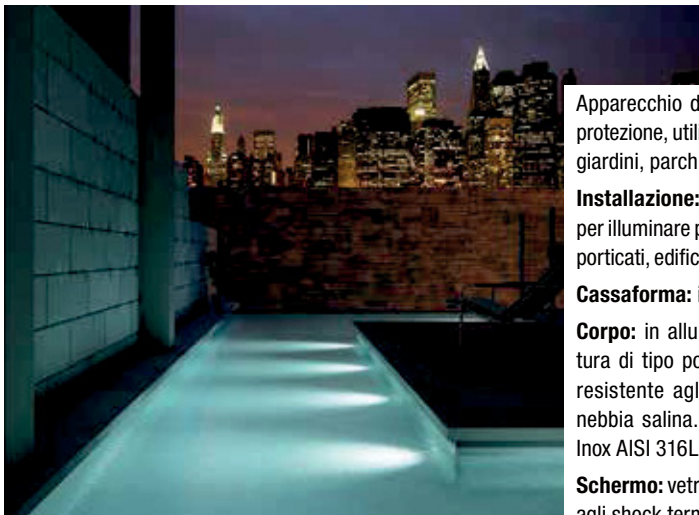

Apparecchio da esterno, ad alto grado di protezione, utilizzabile ad incasso ideale per giardini, parchi, aiuole, terrazzi.

**Installazione:** incassi a pavimento adatti per illuminare percorsi pedonali, aree verdi, porticati, edifici sia residenziali che pubblici.

**Cassaforma:** inclusa.

**Corpo:** in alluminio pressofuso. Verniciatura di tipo poliestere eseguita a polvere resistente agli agenti atmosferici e alla nebbia salina. Ghiera e viterie in acciaio Inox AISI 316L.

**Schermo:** vetro temperato 4mm resistente agli shock termici e agli urti.

**Guarnizioni:** in gomma silconica.

**Norme di riferimento**

EN60598-1; EN60598-2-1; EN62471; EN62031; EN61547

**Sorgente:** LED COB 30W Full color

Luminaire for outdoor use, with high protection degree, for recessed installation, for gardens, parks, flowerbeds

**Installation:** floor recessed luminaires suitable for illuminating pedestrian paths, green areas, porches, buildings either public or domestic.

**Recessed housing:** included.

**Housing:** die-cast aluminium body. Polyester powder coating. Resistance to atmospheric agents and corrosion guaranteed in saline mist. Closing ring and screws in stainless steel AISI 316L.

**Shield:** 4mm tempered glass resistant against thermal shocks and collisions.

**Gaskets:** made with silicone rubber.

**Standard reference**

EN60598-1; EN60598-2-1; EN62471; EN62031; EN61547

**Source:** LED COB 30W Full color

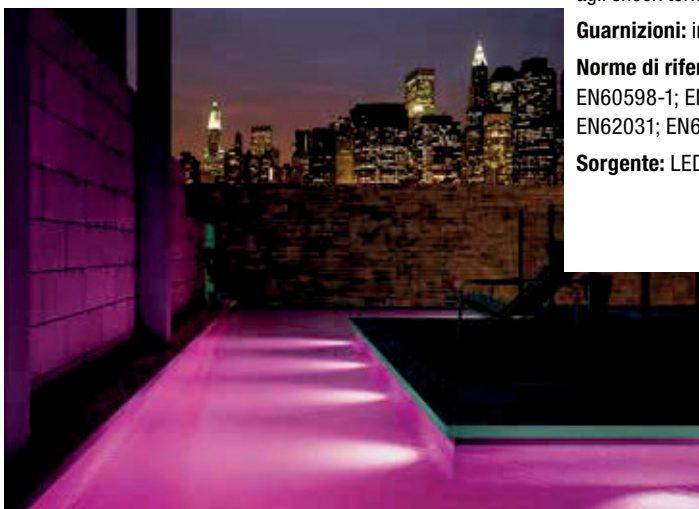

RGB

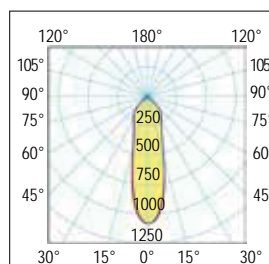

**25°**  
Semi concentrante - *Spot*

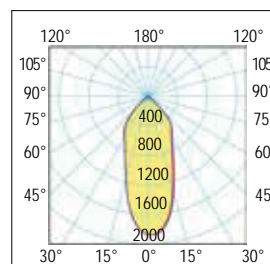

A richiesta - *On demand*  
**40°**  
Intermedio - *Medium*

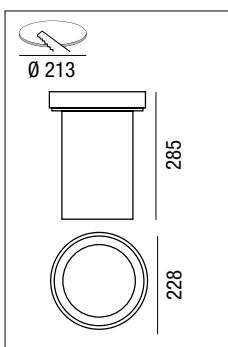
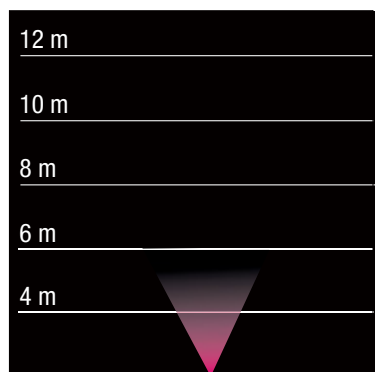

220-240 Vac	50/60 Hz	IP67	IK10	+40 C -20	850°		
		CE	Driver included				

colour	W	angle	K	nominal lm tc = 25°C	lm output	lm/W	pcs	Kg	CELL
C	30	25°	FULL COLOR		R = 145 - G = 320 B = 75	-	1	3,8	32567/RGB

# LED Rondò RGB

Schema di collegamento - *Wiring diagram*

KE2  
DMX controller

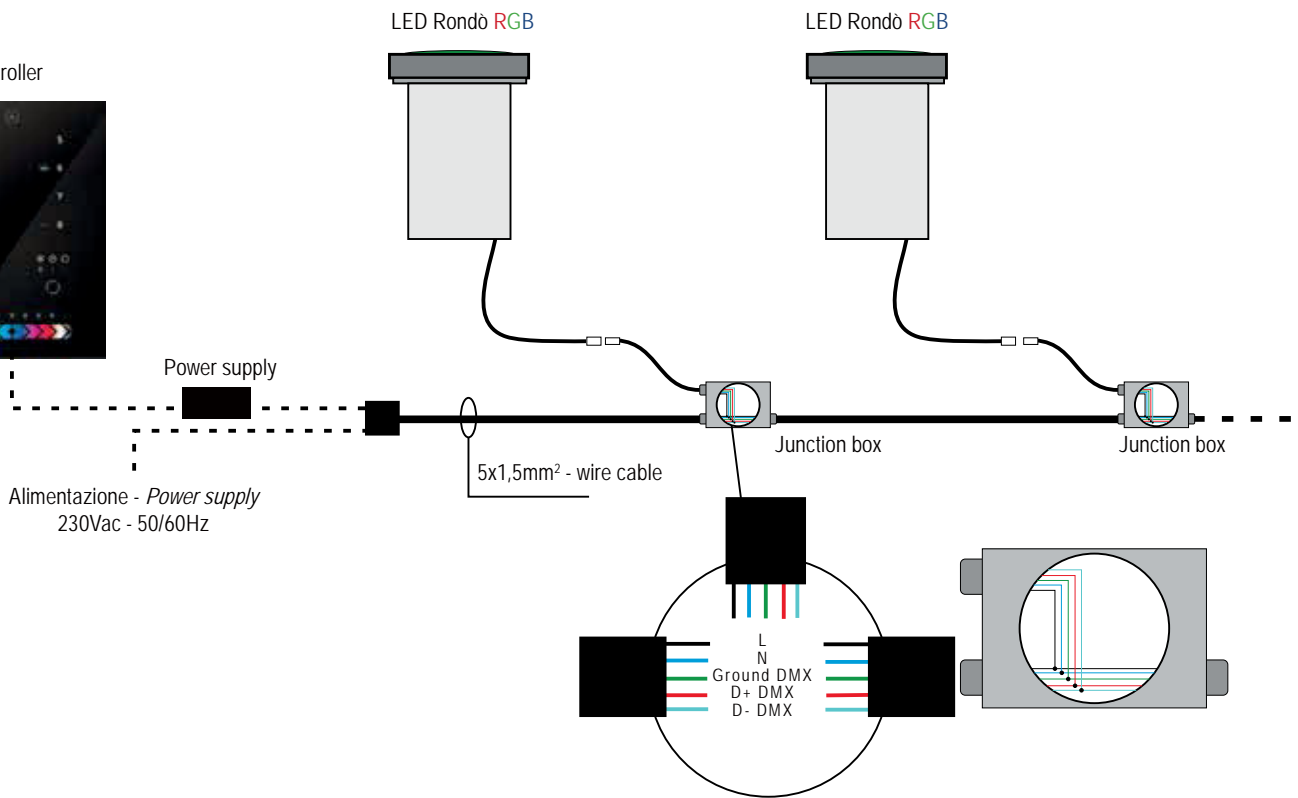

Cod. KE2 - DMX controller (Pag. 207)

La centralina di controllo DMX è la soluzione perfetta per qualunque esigenza di controllo dell'illuminazione interna.

*This complete stand alone wall-mounted DMX controller is the perfect answer to interior lighting control expectations.*



Calpestabile e carrabile, fino a 10Km/h - 1000 Kg con pneumatici gonfiati ad aria. Non sostare.

*Walkable and suitable for vehicles, up to 10Km/h - 1000Kg with tyres inflated with compressed air. Do not stand.*

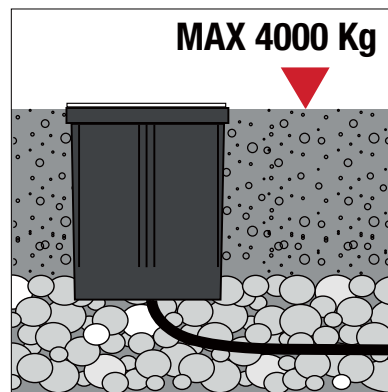

In caso di posa in muratura, la struttura muraria deve sostenere un carico di 4000 Kg. Il fondo della cassaforma è aperto, si rende necessario un fondo di ghiaia per il drenaggio.

*In the event of masonry laying, the wall structure must withstand a load of 4000 Kg. The bottom of the framework is open, it's necessary a gravel bottom for drainage.*

# LED FLEX RGB IP67



24Vdc

IP67

colour	W/m	Pitch	Led/mt*	Lm/m	Efficiency	pcs	Kg	S+L
T	14,4	60 LED RGB 5050	FULLCOLOR	600	42	1	0,38	90.001/RGB24V

Le misure di cui sopra possono avere una tolleranza del 10%.  
The above measurements can have a 10% tolerance

\*Quantità dei LED per metro lineare  
Quantity of LEDs per linear metre



## Accessori inclusi - Included accessories

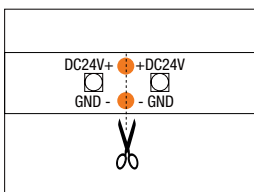

### Per codici IP67 - For IP67 code

La confezione contiene, clip di fissaggio, tappi di chiusura, cavi di collegamento IP ad alimentatore, tubo silicone per ripristino IP, connessioni iniziale e finale strip e per collegamento in serie. Le strip possono essere sezionate ad interassi prefissati; in caso di tagli intermedi utilizzare i tappi inclusi ed assicurarsi di sigillare accuratamente le estremità tagliate.

The package contains fixing clips, closure caps, IP connection cables to power supply, silicone hose for IP reset, initial and final strip connections and connection in series. The strips can be sectioned at preset intervals; in the case of intermediate cuts, use the included caps and make sure to carefully seal the cut ends.

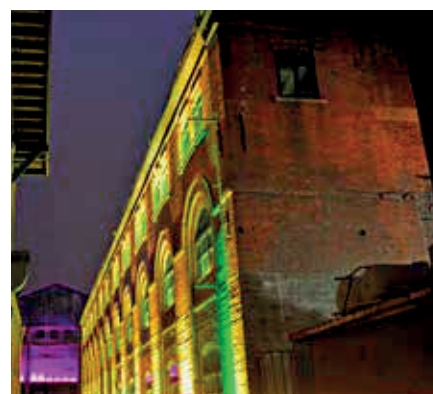

Effettuare il taglio in corrispondenza del simbolo della forbice e la linea tratteggiata.

Make the cut in correspondence of the scissor symbol and dotted line.



# LED Flex COB - Digital RGB 24 Vdc IP20



24Vdc



CRI 90 IP20

colour	W/m	Pitch	K	Lm/m	Efficiency	pcs	Kg	Width mm.	S+L
T	5	100	Red	90	15	1	0,20	12	RCOB630212-D
	5		Green	240	40				
	5		Blue	48	8				
	11		Mixed white	350	25				

Strip LED, ideali per illuminazione lineare e indiretta.  
Ingresso a bassa tensione 24Vdc per la sicurezza umana.

Strip LED ideal for linear and indirect lighting.  
24Vdc low voltage input for human safety.

# LED Flex RGB

Comando sincronizzato con pulsante isolato - *Synchronizd control with isolated button*

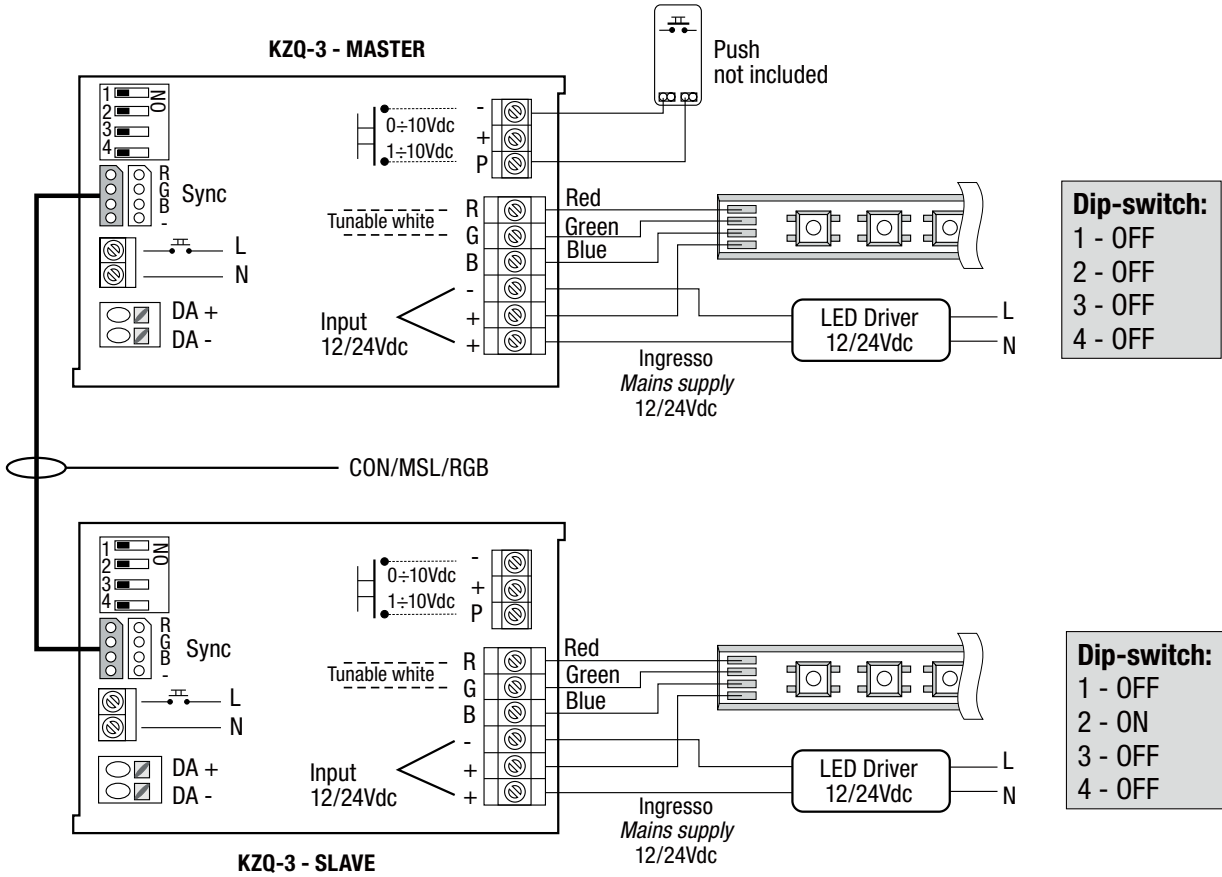

Esempio applicativo con centralina DMX - *Application example with DMX control uni*

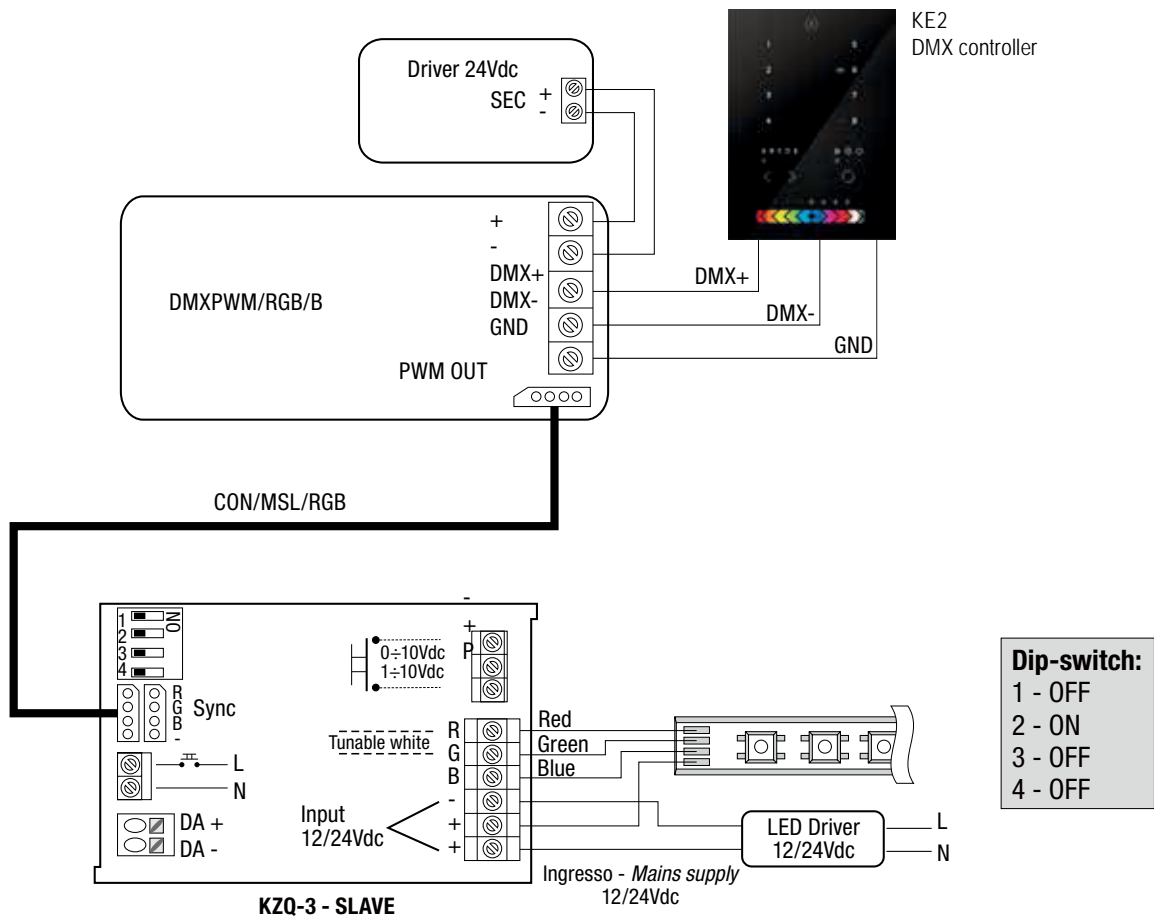

# LED Lampo RGBW

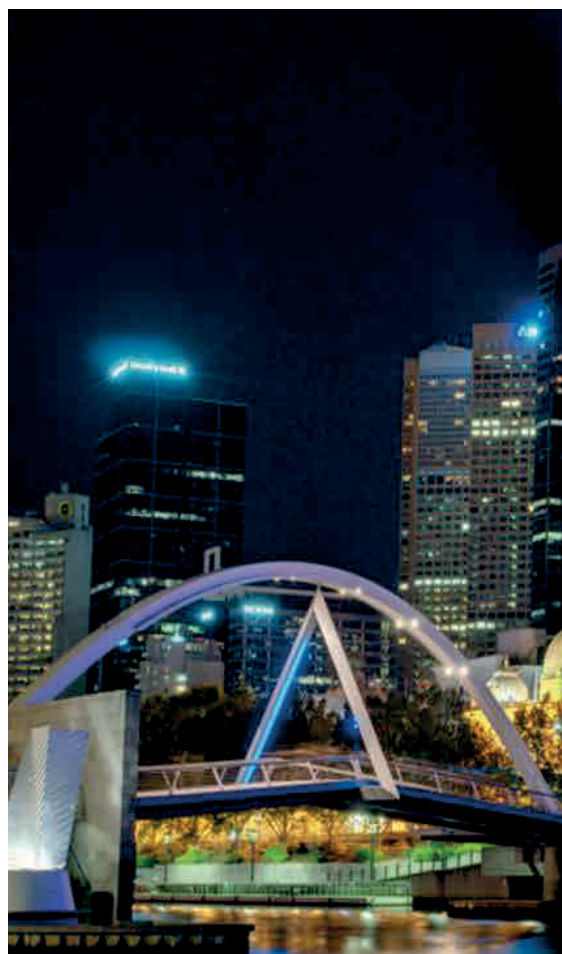

Innovativi proiettori a LED di semplice installazione. Per applicazioni professionali nell'illuminazione di facciate, portici, sottopassaggi e in generale per l'illuminazione di particolari elementi architettonici.

**Installazione:** sospensione, parete/plafone e testa palo (completo di staffa di fissaggio).

**Corpo:** in alluminio estruso anodizzato.

**Telaio:** in acciaio verniciato con polvere termoindurente poliester.

**Staffa di fissaggio:** in acciaio, verniciata con polvere termoindurente poliester

**Verniciatura:** di tipo poliester eseguita a polvere, resistente agli agenti atmosferici e alla corrosione. Colore Grigio RAL 9007.

**Ottica:** diffondente

**Lenti:** PMMA autoestinguenti antiurto

**Protezione alle sovratensioni inclusa:**

Modo differenziale 6kV (L-N)

Modo comune 10kV (L-GND, N-GND, L&N-GND)

**LED Driver e Controller RGBW inclusi:** 

Conforme alla Norma: IEC 61000-4-5.

Fattore di potenza:  $\geq 0,98$

**Norme di riferimento**

IEC 61000-4-5; EN 60598-1;

EN60598-2-1; EN62471; EN62031;

EN60598-2-5; EN61547

*Innovative LED projectors that are easy to install. For professional lighting applications on facades, arcades, tunnels and generally to light up particular architectural elements.*

**Installation:** on vertical and horizontal surfaces (complete with fixing bracket)

**Housing:** anodized extruded aluminium.

**Frame:** in steel painted with thermosetting polyester powder.

**Fixing bracket:** made by stainless steel, coated with polyester thermoset powder.

**Coating:** coated with powdered polyester, resistant to atmospheric agents and corrosion. Grey colour RAL 9007

**Optic:** diffused

**Lenses:** self-extinguishing shockproof PMMA

**Protection against overvoltages included:**

Differential mode 6kV (L-N)

Standard mode 10kV (L - GND, N-GND, L&N-GND).

**LED Driver and RGB controller:** 

Conforming to IEC 61000-4-5.

Power factor:  $\geq 0,98$

**Standard reference**

IEC 61000-4-5; EN60598-1;

EN60598-2-1; EN62471; EN62031;





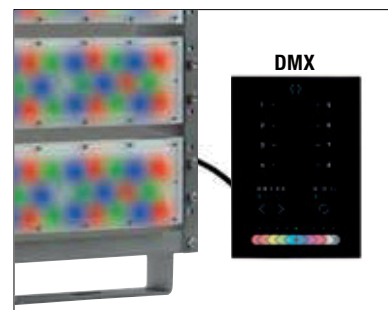
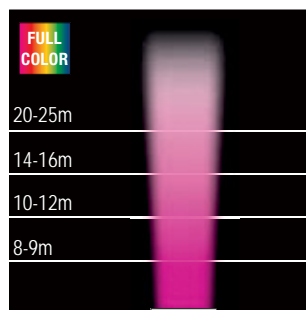
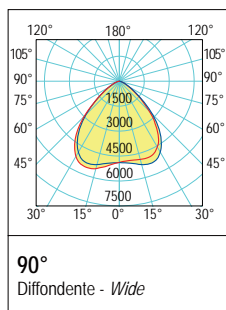

EN60598-2-5; EN61547

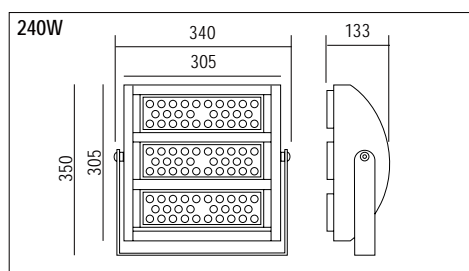
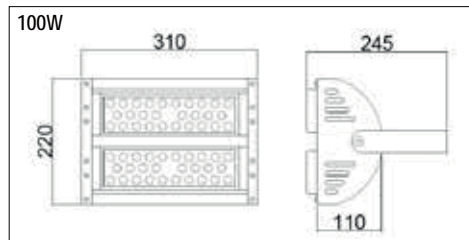
RGB



Lampo RGB 240W



100-240 Vac	50/60 Hz	IP66	IK10	+40 C -40	850°		
		CE	Driver included				

colour	W	LED	angle	lm output	pcs	Kg	CELL
G	100	FULL COLOR	90°	R = 480 - G = 1000 - B = 400 W = 1800	1	2,90	RFL90-RGB
G	240	FULL COLOR	90°	R = 960 - G = 2000 - B = 800 W = 3600	1	5,40	

# LED Lampo RGBW

Schema di collegamento - *Wiring diagram*

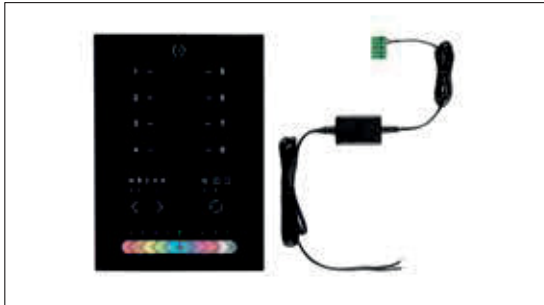
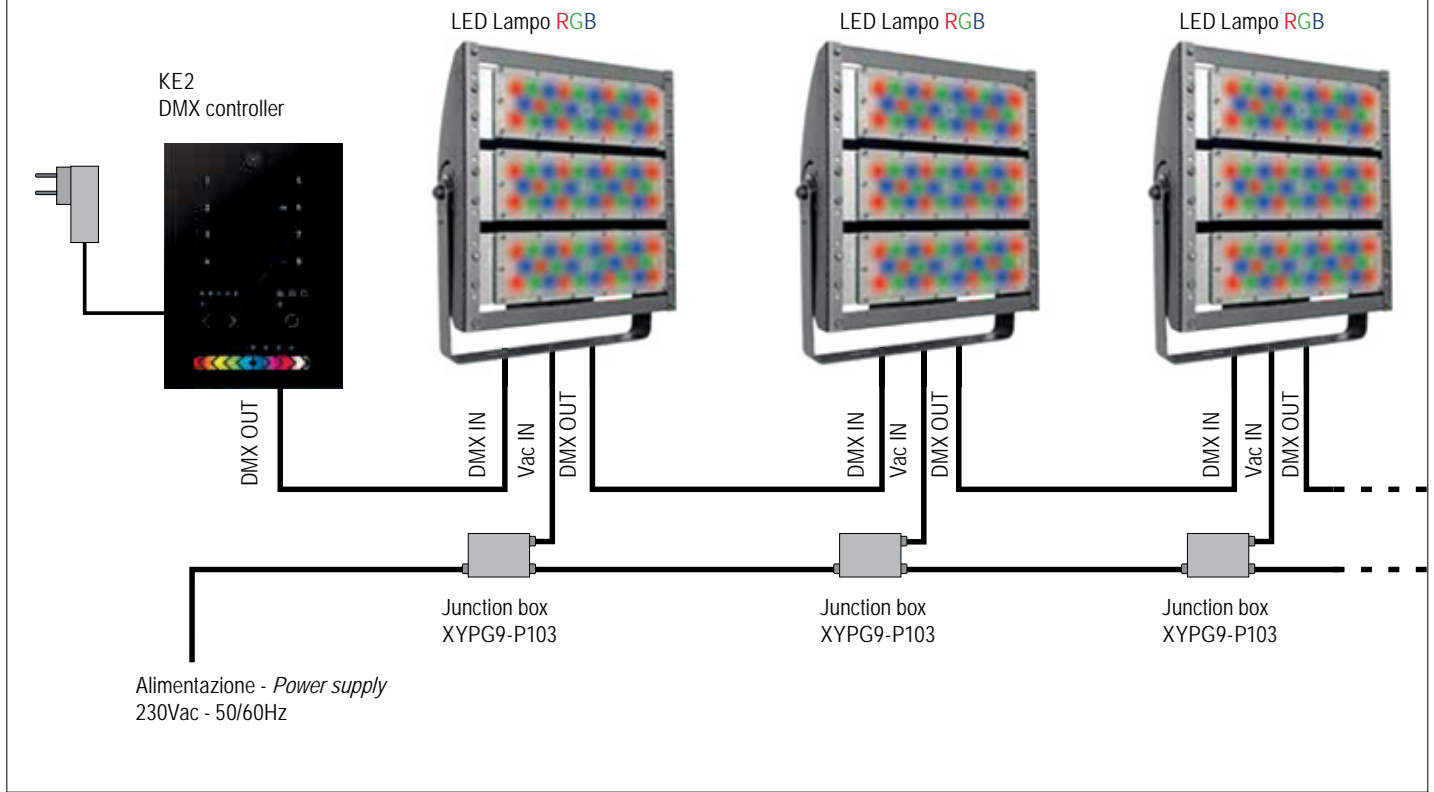

Cod. KE2 - DMX controller (Pag. 207)

La centralina di controllo DMX è la soluzione perfetta per qualunque esigenza di controllo dell'illuminazione interna.

*This complete stand alone wall-mounted DMX controller is the perfect answer to interior lighting control expectations.*

## Ottiche a richiesta - *Optics on demand*

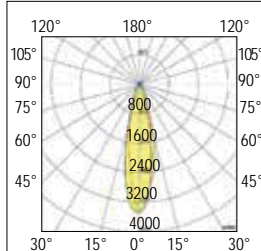

25°  
Concentrante - *Spot*

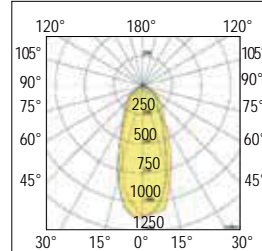

40°  
Semi-diffondente - *Wide*

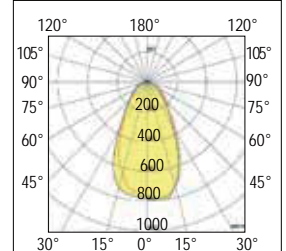

60°  
Diffondente - *Flood*

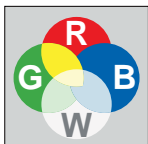

Questa tecnologia consente di ottenere un bianco puro oltre a tutte le gradazioni cromatiche, senza l'influenza dei colori RGB (vedi foto).

*This technology makes it possible to achieve pure white in addition to every shade of colour, without the influence of RGB colours.*



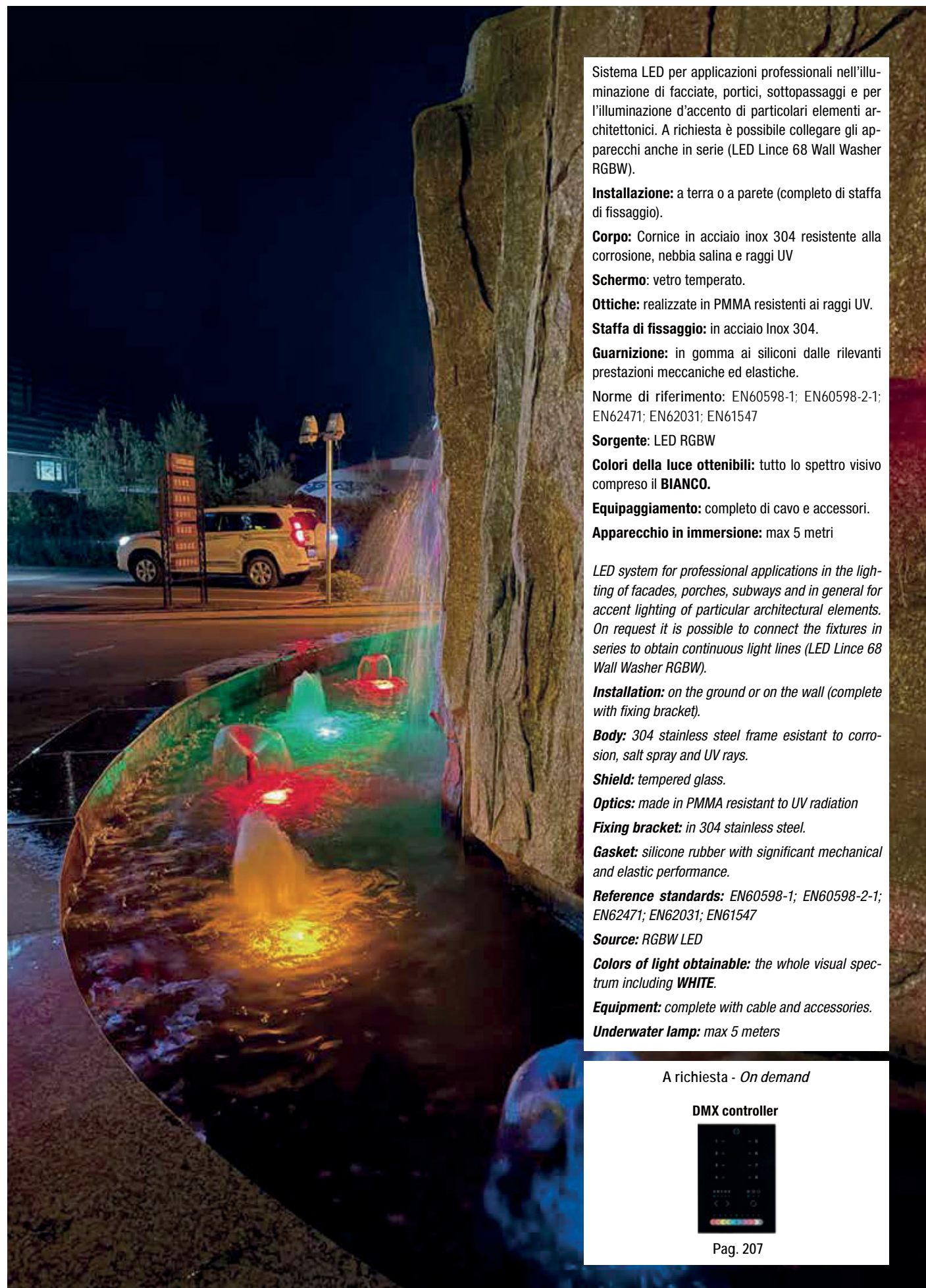

Sistema LED per applicazioni professionali nell'illuminazione di facciate, portici, sottopassaggi e per l'illuminazione d'accento di particolari elementi architettonici. A richiesta è possibile collegare gli apparecchi anche in serie (LED Lince 68 Wall Washer RGBW).

**Installazione:** a terra o a parete (completo di staffa di fissaggio).

**Corpo:** Cornice in acciaio inox 304 resistente alla corrosione, nebbia salina e raggi UV

**Schermo:** vetro temperato.

**Ottiche:** realizzate in PMMA resistenti ai raggi UV.

**Staffa di fissaggio:** in acciaio Inox 304.

**Guarnizione:** in gomma ai siliconi dalle rilevanti prestazioni meccaniche ed elastiche.

Norme di riferimento: EN60598-1; EN60598-2-1; EN62471; EN62031; EN61547

**Sorgente:** LED RGBW

**Colori della luce ottenibili:** tutto lo spettro visivo compreso il **BIANCO**.

**Equipaggiamento:** completo di cavo e accessori.

**Apparecchio in immersione:** max 5 metri

*LED system for professional applications in the lighting of facades, porches, subways and in general for accent lighting of particular architectural elements. On request it is possible to connect the fixtures in series to obtain continuous light lines (LED Lince 68 Wall Washer RGBW).*

**Installation:** on the ground or on the wall (complete with fixing bracket).

**Body:** 304 stainless steel frame resistant to corrosion, salt spray and UV rays.

**Shield:** tempered glass.

**Optics:** made in PMMA resistant to UV radiation

**Fixing bracket:** in 304 stainless steel.

**Gasket:** silicone rubber with significant mechanical and elastic performance.

Reference standards: EN60598-1; EN60598-2-1; EN62471; EN62031; EN61547

**Source:** RGBW LED

**Colors of light obtainable:** the whole visual spectrum including **WHITE**.

**Equipment:** complete with cable and accessories.

**Underwater lamp:** max 5 meters

A richiesta - On demand

DMX controller

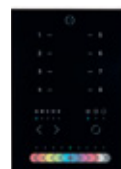

Pag. 207

# LED Lince 68 RGBW

**NEW**

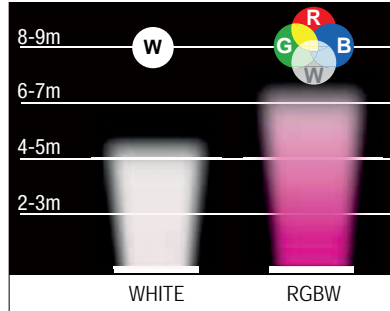
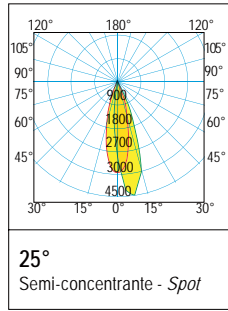

Questa tecnologia consente di ottenere un bianco puro oltre a tutte le gradazioni cromatiche, senza l'influenza dei colori RGB (vedi foto).  
This technology makes it possible to achieve pure white in addition to every shade of colour, without the influence of RGB colours.

24Vdc IP68 IK08 +60°C/-25°C 850° Driver NOT included CE FULL COLOR

colour	W	angle	LED	lm -output	pcs	Kg	S+L
S	36	25°	FULL COLOR	R = 235 - G = 351 - B = 85 W = 380 (6500K)	001	1,440	RGBW16DMX

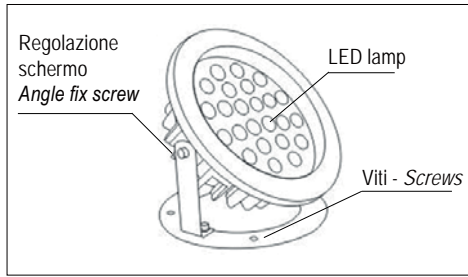
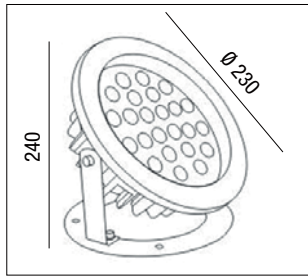

# LED Lince 68 Wall Washer RGBW

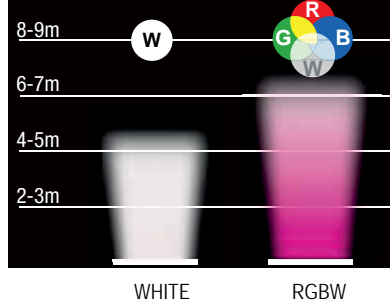
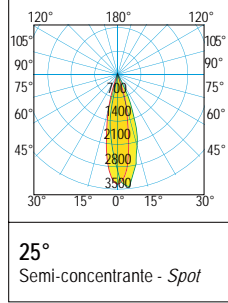

Questa tecnologia consente di ottenere un bianco puro oltre a tutte le gradazioni cromatiche, senza l'influenza dei colori RGB (vedi foto).  
This technology makes it possible to achieve pure white in addition to every shade of colour, without the influence of RGB colours.

24Vdc IP68 IK08 +60°C/-25°C 850° Driver NOT included CE FULL COLOR

colour	W	angle	LED	lm -output	pcs	Kg	S+L
S	36	25°	FULL COLOR	R = 198 - G = 304 - B = 75 W = 335 (6500K)	001	1,440	RGBW18DMX

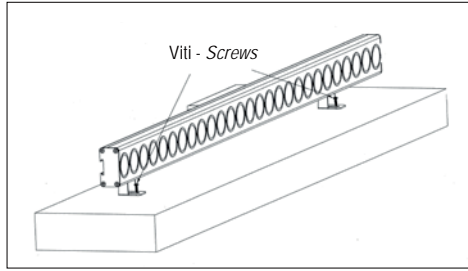
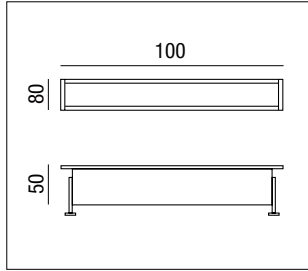

RGB

LED Lince 68 RGBW - Schema di collegamento - *Wiring diagram*

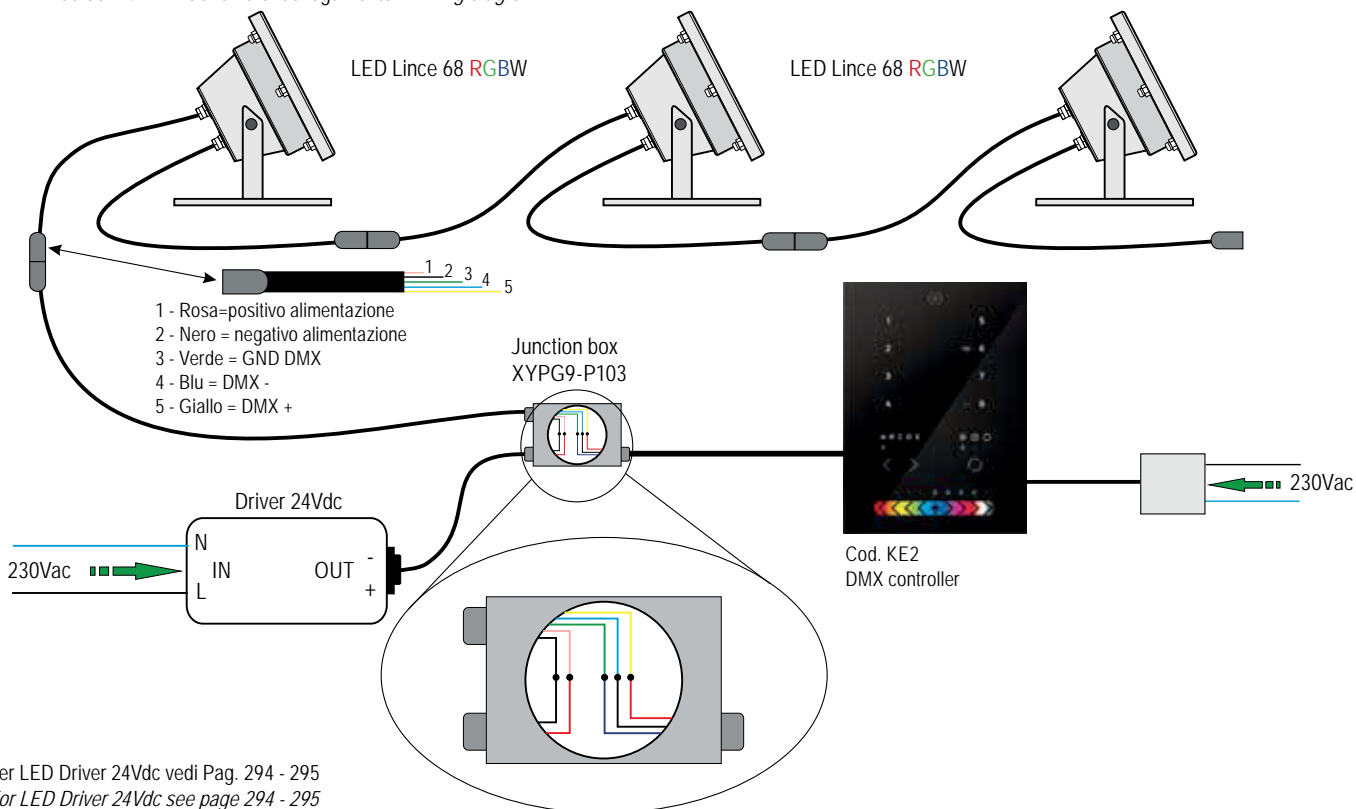

LED Lince 68 Wall Washer RGBW - Schema di collegamento - *Wiring diagram*

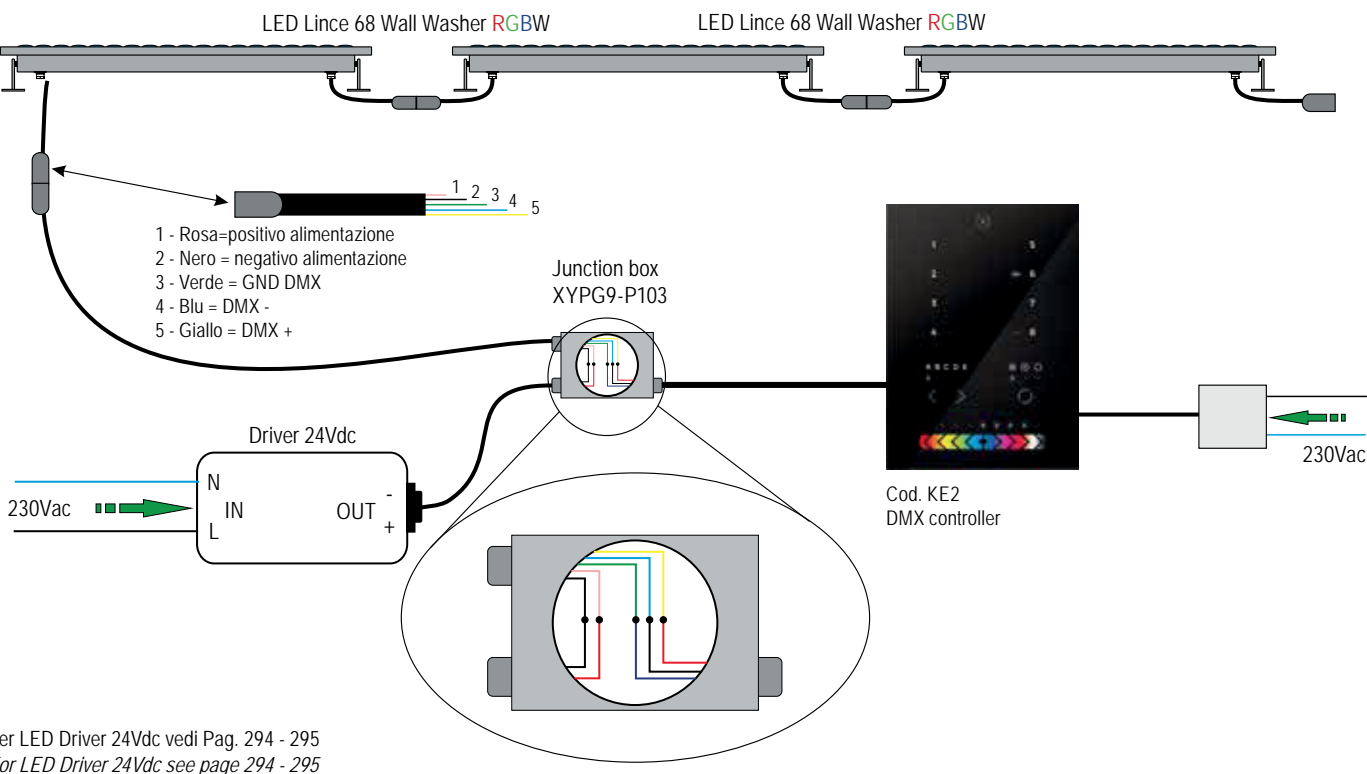

# Accessori - Accessories



Cod. KE2

Centralina di controllo DMX utilizzabile in modalità stand alone.

Nel prezzo di questo codice non è inclusa la programmazione DMX control unit for use in stand alone mode.

Programming is not included in the price of this code

ALTRI MODELLI PIÙ ECONOMICI SONO ACQUISTABILI ON-LINE  
CHEAPER MODELS CAN BE PURCHASED ONLINE

Controller DMX programmabile in grado di funzionare in modalità stand alone. Selezione delle scene programmate tramite tastiera touch: pulsanti per la selezione dello scenario, regolazione luminosità, selezione colore, velocità scenografia, accensione/spegnimento.

- Compatibile con USITT DMX512A
- Connessione USB per programmazione
- Canali DMX 2x512
- Controllo touch panel
- Programmazione tramite pc
- Memoria esterna micro SD 512 Mb (fornita)
- Alimentatore per il funzionamento in modalità stand alone (fornito)

Programmable DMX controller capable of operating in stand alone mode. Selection of the programmed scenes via the touch keyboard: buttons for selecting the scenario, adjusting the brightness, selecting the color, setting speed, on / off.

- Compatible with USITT DMX512A
- USB connection for programming
- 2x512 DMX channels
- Touch panel control
- Programming via PC
- 512 Mb micro SD external memory (supplied)
- Power supply for stand alone operation (supplied)



Cod. DMXPWM/RGB/B

Interfaccia di connessione per FLEX LED RGB e LED GARGANO RGB

Interface for connection for FLEX LED RGB and LED GARGANO RGB

Il prodotto DMXPWM/RGB è un'interfaccia di connessione fra sistemi DMX e moduli slave per il controllo colore.

Ogni interfaccia DMXPWM/RGB usa 3 canali DMX per generare 3 segnali di controllo colore (Rosso - Verde - Blu), che vengono inviati al modulo Slave per il controllo colore.

L'interfaccia DMXPWM/RGB dispone di 10 Dip-Switches per impostare (in codice binario) l'indirizzo "X" del primo canale DMX usato dall'interfaccia

The DMXPWM/RGB product is an interface for connection between DMX systems and RGB slave dimmers.

Each DMXPWM/RGB interface uses 3 DMX channels to generate 3 colour (Red, Green and Blue) control signals, which are sent to RGB slave dimmer.

The DMXPWM/RGB interface has got 10 Dip-Switches to set the "X" address of the first DMX channel used by interface.



KZQ-1 - Cod. 30928

Controller per FLEX LED RGB

FLEX LED RGB controller

Controller RGB per uso indipendente con comando a pulsante incorporato da abbinare agli alimentatori Miniled.

Potenza: 30W - V out: 12Vdc - V in: 12Vdc

Il passaggio da un programma all'altro avviene premendo il pulsante ed è evidenziato da un diverso segnale acustico tipo beep. Il pulsante di comando è integrato nel regolatore ed è in grado di gestire tre differenti programmi luminosi

- 1) Un colore monocromatico a luce fissa (1 Beep)
- 2) Cambio dei colori di tipo passo-passo (2 Beeps)
- 3) Cambio dei colori di tipo ciclico FULL COLOR (3 Beeps)
- 4) Spegnimento (4 Beeps).

RGB controller for independent use with incorporated push-button control to be continued with Mini-led feeders.

Potenza: 30W - V out: 12Vdc - V in: 12Vdc

The passage from one program to another occurs by different beep-type acoustic signal.

The control button is integrated in the regulator, and is able to manage three different lighting programs.

- 1) A monochromatic colour with steady light (1 Beep)
- 2) Step-by-step colour change (2 Beeps)
- 3) Cyclical FULL COLOR change (3 Beeps)
- 4) Turn off (4 Beeps).

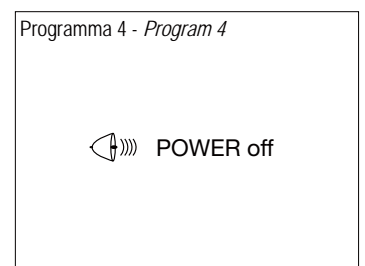
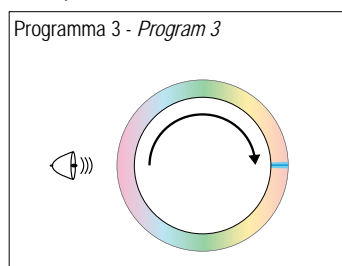
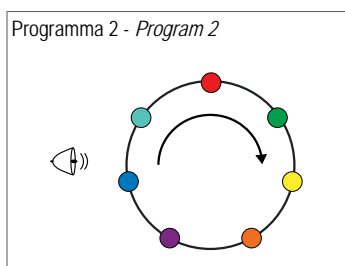
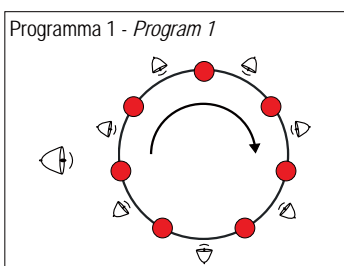

## Accessori - Accessories



KZO-3 - Cod. 30948

Controller per **FLEX LED RGB** - *FLEX LED RGB controller*

La regolazione può avvenire nei seguenti modi:	Adjustment can be made as follows:
Pulsante NA selv (isolato da rete)	<i>Selv NO push-button (mains insulated)</i>
Pulsante NA non selv (riferito sulla rete)	<i>Non Selv NO push-button (referred to on mains)</i>
Ciclo continuo all'accensione con atmosfere preimpostate	<i>Continuous cycle at start-up with preset atmospheres</i>
Regolazione singoli colori	<i>Adjusting individual colors</i>
Selezione sequenza singoli colori	<i>Individual color sequence selection</i>
Regolazione DMX tramite convertitori DMX/PWM	<i>DMX adjustment via DMX/PWM converters</i>

**Regolazione a pulsante:** la regolazione RGB avviene agendo direttamente sul pulsante. L'accensione e lo spegnimento avvengono tramite un breve tocco sul pulsante. Per ottenere la regolazione RGB, premere il pulsante sino a raggiungere il colore desiderato, una volta raggiunto interrompere il contatto. Sarà inoltre possibile, previa impostazione dei dip-switch, dimmerare i singoli colori, oppure ottenere l'accensione, ad ogni pressione del pulsante la sequenza dei colori fissi RGB. **Memoria del livello,** salvo interruzioni di rete.

**Atmosfere preimpostate:** all'accensione dell'impianto, tramite interruttore di rete, il ciclo RGB inizierà a ciclare in automatico

**Regolazione dei singoli colori:** selezionare tramite dip-switch il colore da regolare, sarà quindi possibile effettuare la regolazione a pulsante.

**Accensione sequenziale dei singoli colori:** selezionare la funzione tramite dip-switch. Ad ogni pressione del pulsante si avrà l'accensione dei singoli colori alla massima intensità.

**Regolazione DMX:** la regolazione tramite centraline DMX è possibile abbinando anche la nostra interfaccia cod. DMX/PWM/RGB/B e cavo di sincronismo CON/MSL/RGB.

**Push-button adjustment:** act on the push button to adjust the RGB. Briefly touch the push-button to switch on and off. To adjust the RGB, press the push-button until the desired colour is obtained and then interrupt contact. After setting the dip-switches, single colours may be dimmed or the sequence of RGB steady colours lighted up by pressing the push-button. Level memory, except in case of black outs.

**Preset atmospheres:** when the system is switched on, the RGB cycle will start to automatically run by pressing a mains switch

**Adjustment of individual colors:** select by dip-switch the color to be adjusted, it will then be possible to adjust by button.

**Sequential switching on of the single colors:** select the function via dip-switch. Each time the button is pressed, the individual colors will be turned on at maximum intensity.

**DMX adjustment:** adjustment via DMX control units is also possible by connecting our interface cod. DMX/PWM/RGB/B



Cod. CON/MSL/RGB

Cavo di sincronismo - *Sync cable*

Nel caso in cui sia necessaria gestire una potenza maggiore sarà possibile collegare in modo sincronizzato, tramite cavo di sincronismo, fino ad un massimo di 10 apparecchiature selezionando, con i dip-switch, il funzionamento MASTER-SLAVE.

*Should greater power be needed, up to a maximum of 10 devices can be connected in a synchronized way, using a sync cable, by selecting MASTER-SLAVE operation via dip-switches.*

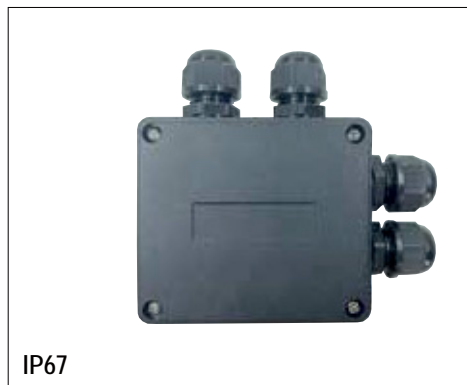

IP67

Cod. XPG9-P104

Accessorio IP67 per linee di luce continua  
IP67 accessory for continuous light lines.



IP67

Cod. XYPG9-IP67

Accessorio IP68 per linee di luce continua  
IP68 accessory for continuous light lines.

**NEW**

**VS LIGHTING SOLUTIONS**

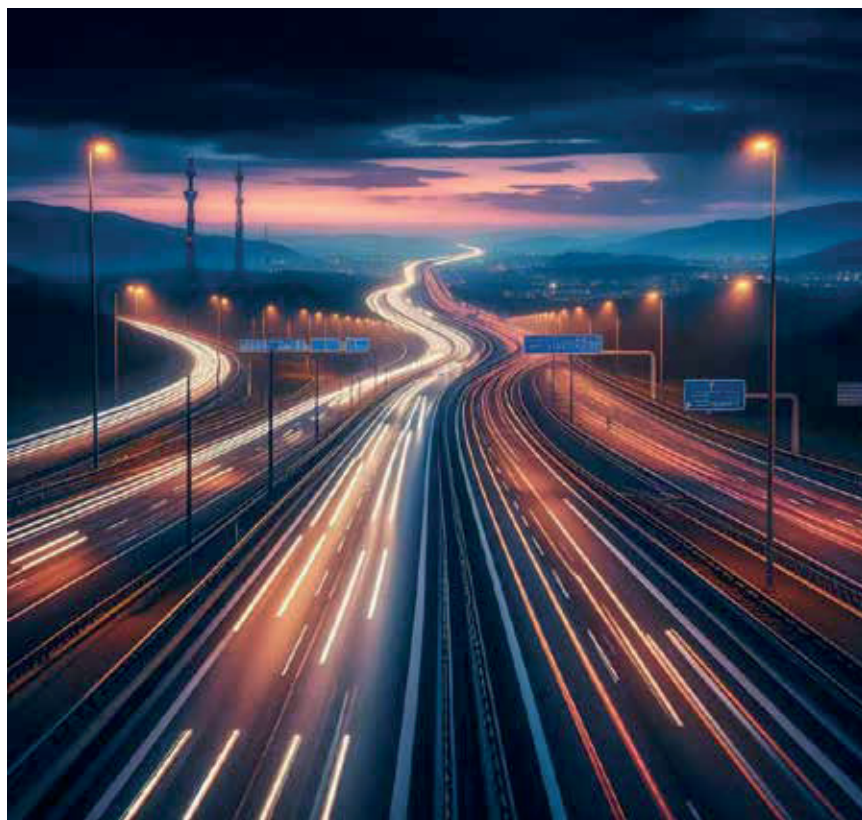

## Collegiamo la luce per te - We connect light for you

Blu2Light è da anni un sistema di controllo wireless ben collaudato per qualsiasi tipo di applicazione di illuminazione interna. Ora è possibile utilizzare la stessa tecnologia per le applicazioni di illuminazione stradale e anche l'illuminazione architettonica : Gestione della luce - scenari - presenza - dimmerazione - Astro Time Switching - Integrazione di planimetrie e mappe stradali - Integrazione della comunicazione

### **SICUREZZA prima di tutto!**

CODICE QR UNIVOCO Crittografia grazie alla scansione del codice QR

Le connessioni MESH sono crittografate

La comunicazione Bluetooth® è crittografata

**New - Controller Bluetooth® (versione NEMA e ZHAGA socket) per la gestione di apparecchi di illuminazione stradale**

**New - Controller Bluetooth® con GPS integrato (versione NEMA e ZHAGA socket) per la gestione di apparecchi di illuminazione stradale**

**New Controller IP67 Bluetooth® per applicazioni da esterno**

Blu2Light has been a well-proven wireless control system for any type of indoor lighting application for years.

Now you can use the same technology for street lighting applications and also architectural lighting:

Light management - scenarios - presence - dimming - Astro Time Switching - Integration of floor plans and road maps - Communication integration

### **SAFETY first!**

UNIQUE QR CODE Encryption thanks to QR code scanning

MESH connections are encrypted

Bluetooth® communication is encrypted

**New - Bluetooth® Controller (NEMA and ZHAGA socket versions) for the management of street lighting fixtures**

**New - Bluetooth® Controller with integrated GPS (NEMA and ZHAGA socket versions) for the management of street lighting fixtures**

**New IP67 Bluetooth® Controller for outdoor applications**